



CONTENTS

Recessed Modular



Officelyte
Page 9



Kometa 500
& 600
Page 13



Equilibro
Page 16

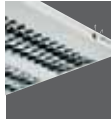

3.4.T5
Page 17



Sylproof Pro
Page 18



Sylwing R
Page 20

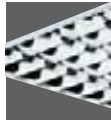

Sylpack 2
Page 21

Direct / Indirect

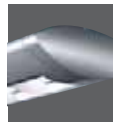

Ovation 65
Page 25



Decapo
Page 34



Triangle
Page 35

Downlights



LED 100 TE
Page 39



LED 150 TE
Page 47

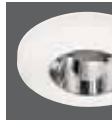

Kometa 300
Page 55



Equinox
Page 61



Performance
Cones
Page 71



Myriad 4
Page 81



RouteLED/
Routelite
Page 89

Ambient



Cassini
Page 93



Opaline
Page 97



Brio
Page 101



Elite
Shaverlight
Page 103



Syl-Safe
Page 104



Recessed
Adjustable



Torus
Recessed
Page 109



Storelyte
Page 119



Lyteframe
Recessed
Page 123

Spotlights



Lytespot
Page 131



Torus
Spotlights
Page 137



Torus
Wallwasher
Page 151



TeQ
Spotlights
Page 153



TeQ Projector
Page 160



TeQ Linear
Page 162



Lyteframe
Suspended
Page 167

Track



Lytespan 1
Page 177



Lytespan LP
Page 182



Lytespan 3
Page 185



Lytebeam
Page 192



Lytespan 3
LED
Emergency
Page 196



Lytebeam
LED
Emergency
Page 197



Universal
Suspensions
Page 199

Pendant



Cassini
Pendant
Page 205



Trio
Page 209

Exterior



Skyline
Page 213



Storm
Page 217



Sterling
Bollard
Page 219

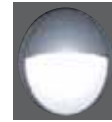

Brio
Page 223



Brio
Vandal
Resistant
Page 225



Sterling
Bulkhead
Page 227

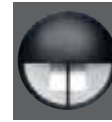

Sterling
Asymmetric
Bulkhead
Page 228



Monitor
Page 229

PRODUCT SPECIFICATION

Concord:marlin guidance for raising a product specification

In order to create a succinct specification for each Concord:marlin product, please use the following list to select from. The relevant information can be found on the either the product introduction pages at the beginning of each section or on individual product pages.

- 1 Product reference code:
- 2 Lamp type and quantity:
- 3 Gear type:
- 4 IP rating:
- 5 IK rating:
- 6 Test marks/approvals:
- 7 Beam angle/Cut off angle/surface brightness:
- 8 Adjustment - Tilt/Rotation:
- 9 LOR/DLOR/ULOR:
- 10 Cutout and recess depth:
- 11 Product dimensions:
- 12 Material specification/body/diffuser/reflector:
- 13 Other

An example of an ideal specification is shown below

To specify, select in order from the following list:

(Page 75)

- | | |
|---|--|
| 1 Product reference code | 2035336 |
| 2 Lamp type and quantity | 1x70w HIT-CE |
| 3 Gear type | Remote |
| 4 IP rating | IP20 |
| 5 IK rating | - |
| 6 Test marks/approvals | F marked, 850°C ENEC |
| 7 Beam angle/Cut off angle/
surface brightness | Beam angle 40° |
| 8 Adjustment - Tilt/Rotation | 0-35° tilt |
| 9 LOR/DLOR/ULOR | DLOR 0.50 |
| 10 Cutout and recess depth | Cut out 160mm x 220mm deep |
| 11 Product dimensions
reflector aperture | 170mm x 220mm
85mm |
| 12 Connections/Mounting | 3 way terminal block |
| 13 Material specification/
body/diffuser/reflector | Reflector super pure specular
aluminium, housing die cast
aluminium powder coated
textured black RAL 9005 |
| 14 Other | - |

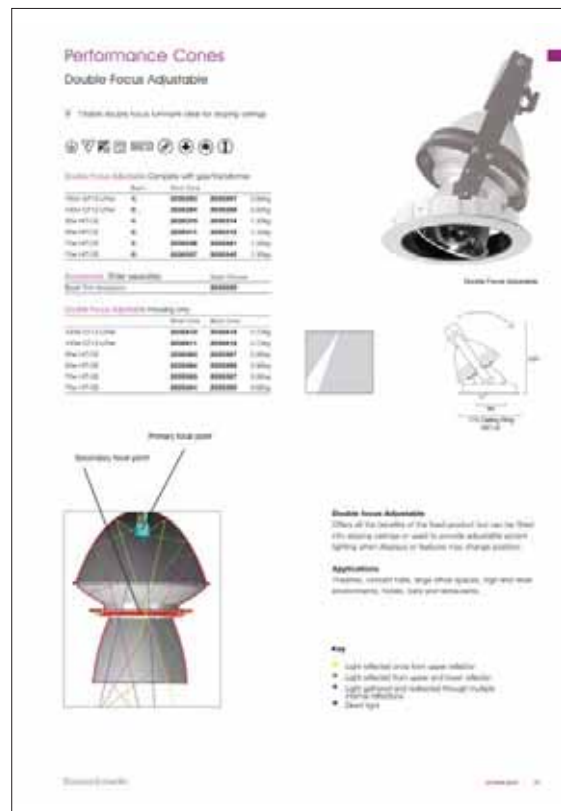

The process of creating individual product datasheets can be automated quickly and easily online. Please visit www.concordmarlin.com and follow the simple procedure below. Datasheets can be created for all Concord:marlin products and can be personalised for specific projects.



Products can be selected from the drop down menu bar found at the top of the page. Search by **Category**, **Application** or **Lamp** type.



Alternatively, select the 'Product' button at the top of the page, which brings up a thumbnail of each product category.



Select the product category you want and click through the screens to the relevant product page, which gives you the opportunity to compare product specifications before making a final decision.



Upon selecting and clicking through to the product you are interested in, you will see the specification page for this individual product.



The specification page can be downloaded as a PDF, which can be printed out and used as part of a project specification. Users can personalise their PDF datasheet by clicking on the 'Personalise your PDF Download' option and adding their contact and project details to each page. Individual datasheets contain all the information required for a succinct specification.



PDF Datasheet

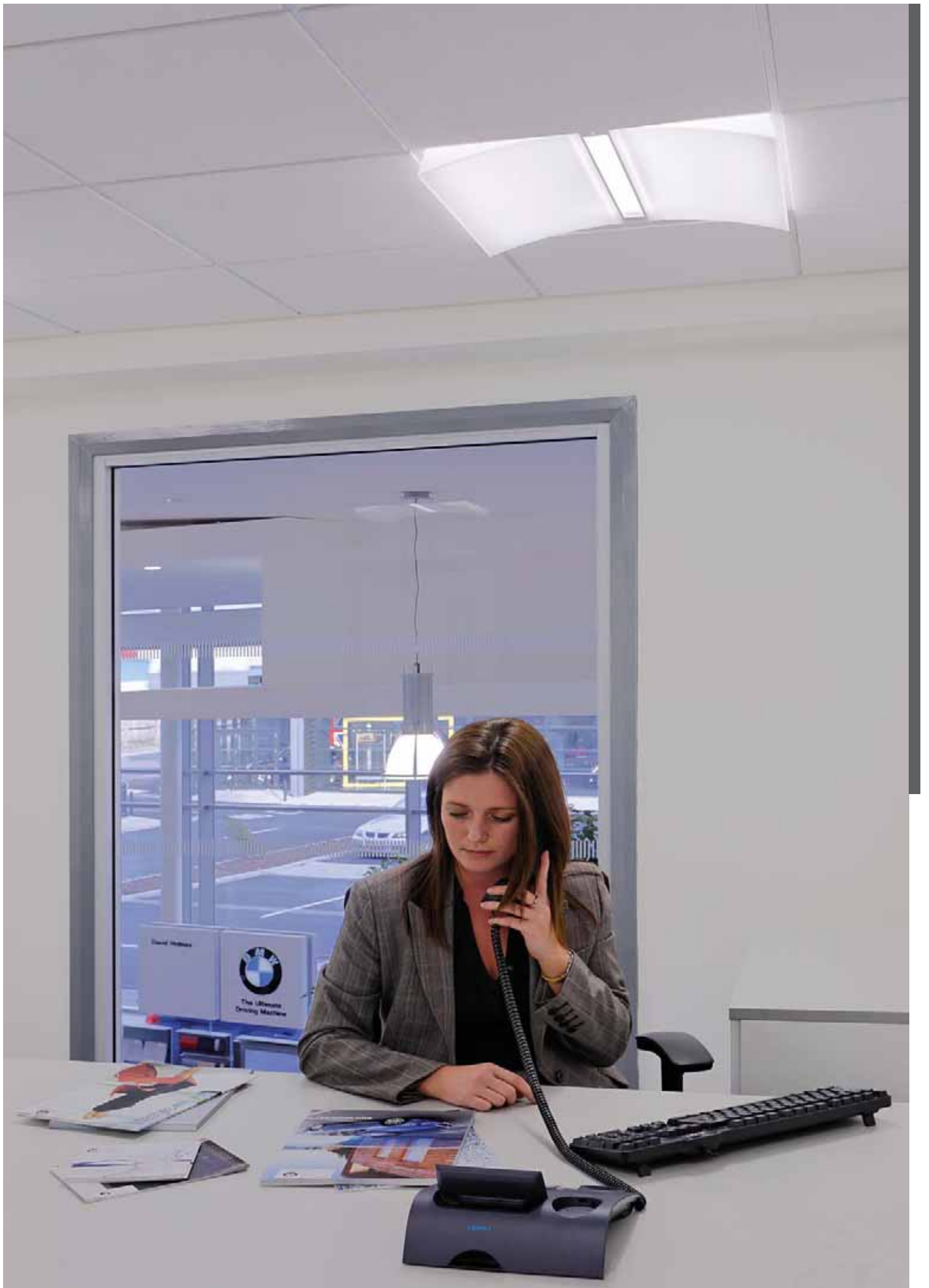

Officelyte

Recessed/Modular



NB Officelyte will aid in compliance with the latest UK LG7 guidelines for surface illumination in the areas of 50% wall illuminance / 30% ceiling illuminance and <math><1500\text{ cd/m}^2</math> glare control (1 x 55w + 2 x 24w versions only). However it is the scheme which is deemed to be compliant and is dependant on factors such as ceiling heights, luminaire spacings and interior décor.

Control Gear:	Standard: Integral electronic Dimmable: Integral electronic PCA ECO Switch Dim and DSI Compatible
Integral Sensor :	Integral Digital DSI sensor module for controlling 25 digital dimmable ballasts and integral sensor with passive infra red motion detector and light sensor for constant light regulation
Emergency:	55w and 24w integral 3 hour maintained 80w remote 3 hour maintained
Reflector:	Miro Superpure Aluminium
Diffuser:	Central: Conical De-glaring Prism Polycarbonate Wings: Satin Polycarbonate
Housing:	Powder Coated Steel RAL 9016

Recessed Modular

- Recessed lay-in
- 1 x 55w TC-L / 2 x 24w T5 lamp options
- Light refracting prism elements
- LEF of over 45 lumens per circuit watt
- Dimmable and emergency versions as standard
- Low glare downward lens (<math><1500\text{ cd/m}^2</math> at and above - Enclosed fitting with IP40 rating
- Draw up accessory kit for pull up and plasterboard applications
- IP40 under canopy/ceiling
- Single point LG7 compliant



Standard

1 x 55w TC-L	2037296	5.60kg
--------------	----------------	--------

Emergency

1 x 55w TC-L	2037297	7.60kg
--------------	----------------	--------

Dimmable

1 x 55w TC-L DSI Dimmable	2037298	5.60kg
---------------------------	----------------	--------

Dimmable Emergency

1 x 55w TC-L DSI Dimmable Emg	2037300	7.60kg
-------------------------------	----------------	--------

Standard

2 x 24w T16	2038964	5.70kg
-------------	----------------	--------

Emergency

2 x 24w T16	2038965	7.70kg
-------------	----------------	--------

Dimmable

2 x 24w T16 DSI Dimmable	2038966	5.70kg
--------------------------	----------------	--------

Dimmable Emergency

2 x 24w T16 DSI Dimmable Emg	2038967	7.70kg
------------------------------	----------------	--------

Accessory

Draw up kit	2039855	
-------------	----------------	--

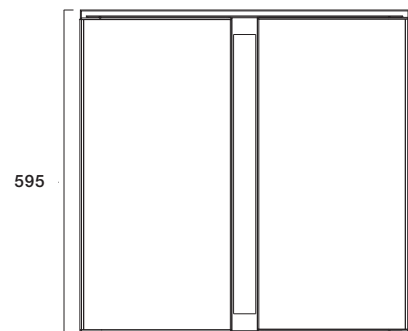
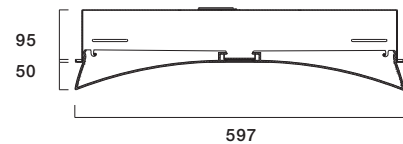
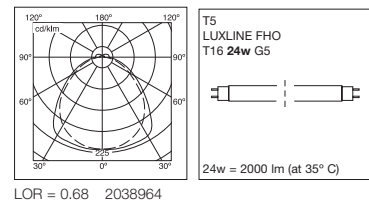
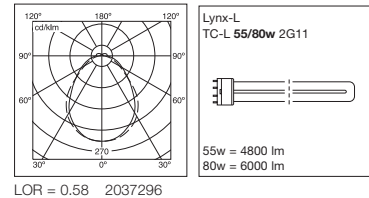

Officelyte MC & Officelyte 80

Recessed Modular Additions

- **New** Officelyte master luminaire with smartDIM SM Ip control unit for controlling up to 25 digital dimmable ballasts and integral smartDIM sensor with passive infra red motion detector and light sensor for constant light regulation. Master luminaires must be connected to Officelyte dimmable luminaires which can then be switched automatically via the presence detector and regulated according to the available ambient light, providing considerable energy savings
- **New** High output Officelyte using new 80w TC-L lamp technology, can provide improved luminaire spacings and increased lux levels and is also ideal for areas with high ceilings
- **New** Officelyte surface mounted accessory for applications when no recessing depth is available such as solid concrete ceilings
- **New** Universal mounting kit for allowing Officelyte to be located in a multitude of different ceiling grids
- **New** Officelyte central CDP coloured gels can be used for way finding solutions and corporate branding

Officelyte MC Master Control

1 x 55w TC-L Integral Sensor DSI Dimmable	2041980	5.70Kg
2 x 24w T16 Integral Sensor DSI Dimmable	2041981	5.80Kg
1 x 80w TC-L Integral Sensor DSI Dimmable	2041982	5.70Kg

Officelyte 80 High Output Standard

1 x 80w TC-L	2041231	5.60Kg
--------------	----------------	--------

Emergency

1 x 80w TC-L	2041232	7.60Kg
--------------	----------------	--------

Dimmable

1 x 80w TC-L DSI Dimmable	2041233	5.60Kg
---------------------------	----------------	--------

Dimmable Emergency

1 x 80w TC-L DSI Dimmable Emg	2041234	7.60Kg
-------------------------------	----------------	--------

Accessories

Surface Mounting Accessory Box*	2041201	2.80Kg
Universal Mounting Kit	2041206	0.05Kg
Central CDP Blue Gel Filter	2041202	
Central CDP Red Gel Filter	2041203	
Central CDP Green Gel Filter	2041204	
Draw Up Kit	2039855	

* Not single point LG7 compliant when used with surface mounting accessory point.
80W version not suitable for surface mounting

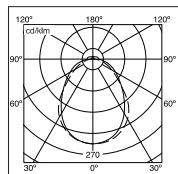

LOR = 0.61 2041231

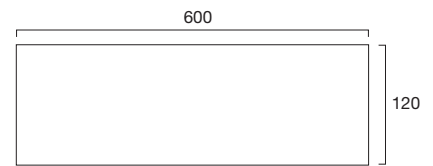

Surface mounting accessory box

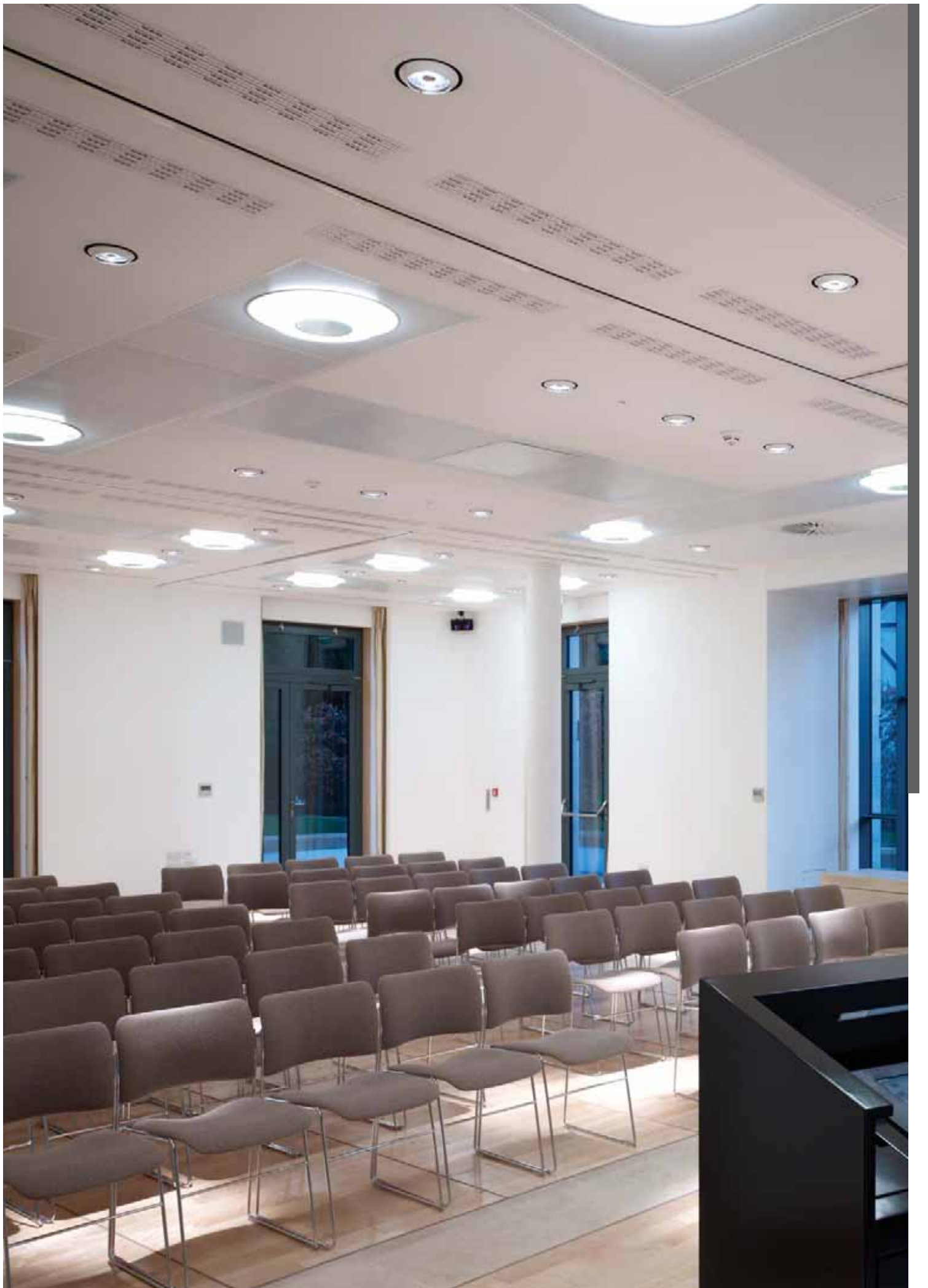

Kometa

Circular/Modular



- Kometa looks and performs like no other lighting fixture by combining ambient lighting with downlighting in a simple stylish luminaire
- It provides the complete lighting solution, without the need to supplement the installation with uplighters and wallwashers, by providing a ceiling illuminance which is 30% of working plane levels and a wall illuminance equivalent to 50%
- The new concept provides a good light ratio on all room surfaces with improved spacings resulting in up to 30% fewer fittings to achieve the same illumination levels as traditional 4 x 18w T8 600 x 600 luminaires
- Complemented by Kometa 300, ideal for corridors, secondary office spaces and circulation areas

Control Gear:	Standard: Integral electronic x 2 Dimmable: Integral electronic x 2 Digital Dimmable PCA Eco Switch Dim and DSI compatible
Emergency:	Integral, 3hr maintained (T5)
Reflector:	Central Downlight: Aluminium, anodised Ambient Reflector: Aluminium, powder coated white RAL 9016
Ambient Diffuser:	Polycarbonate, opal
Tile:	Polycarbonate, Tpa rated smooth or textured finish. Painted white RAL 9010
Mounting:	Steel rod adjustable suspension bars. Factory set for 38mm High T Bar
Extra Load Suspension:	1m stainless steel wire supplied with Griplock

Kometa 500 & 600

Modular

- An innovative circular modular 500 x 500 or 600 x 600 luminaire
- Combines ambient T5 and TC-TE downlight technologies in one
- Ultimate flexibility with independent switching and dimming options
- Kometa is housed within a 600 x 600 ceiling tile for mounting in 15 or 24mm exposed T grids or a 500 x 500 ceiling tile for mounting in 15mm exposed T grids
- Plasterboard and other suspended ceiling grid options available on request
- Provides optimum visual conditions ensuring light falls on all surfaces
- Integral T5 emergency options
- Quick and easy wiring installation with the use of plug and socket arrangement



Kometa 600	15mm		24mm		Weight
	Smooth	Textured	Smooth	Textured	
1 x 26/32w TC-TEL + 40w T16-R	4064670	4064672	4065239	4065241	6.10kg

Emergency	Smooth	Textured	Smooth	Textured	Weight
1 x 26/32w TC-TEL + 40w T16-R	4065257	4065258	4065263	4065264	9.00kg

Dimmable	Smooth	Textured	Smooth	Textured	Weight
1 x 26w TC-TEL + 40w T16-R	4064678	4064680	4065247	4065249	6.10kg
1 x 32w TC-TEL + 40w T16-R	4064674	4064676	4065243	4065245	6.10kg

Dimmable Emergency	Smooth	Textured	Smooth	Textured	Weight
1 x 26w TC-TEL + 40w T16-R	4065261	4065262	4065267	4065268	9.00kg
1 x 32w TC-TEL + 40w T16-R	4065259	4065260	4065265	4065266	9.00kg

Kometa 500	15mm	
	Smooth	Textured
1 x 26/32w TC-TEL + 40w T16-R	2041556	2041689

Emergency	Smooth	Textured
1 x 26/32w TC-TEL + 40w T16-R	2041690	2041691

Dimmable	Smooth	Textured
1 x 26w TC-TEL + 40w T16-R	2041692	2041693
1 x 32w TC-TEL + 40w T16-R	2041696	2041697

Dimmable Emergency	Smooth	Textured
1 x 26w TC-TEL + 40w T16-R	2041694	2041695
1 x 32w TC-TEL + 40w T16-R	2041698	2041699

500 & 600 Accessories Order separately		
Extra Load Suspension 1m	4064843	0.75kg
Kometa optix comfort diffuser	4063966	

NOTE: Use if ceiling grid requires extra support. For maximum load details please contact relevant ceiling manufacturer.

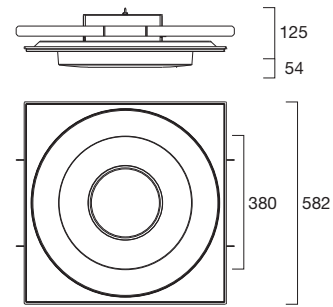

Kometa 600

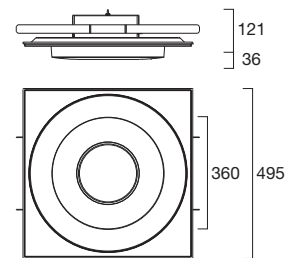

Kometa 500



Kometa 300
see page 55

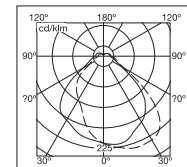

DLOR = 0.54 ULOR = 0.07
4064672

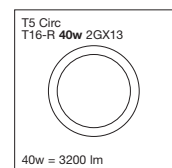
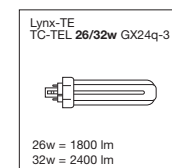

Kometa 500 & 600

Modular



The top render illustrates the performance of a standard recessed 600 x 600 4 x 18w T8 module.

The render below illustrates the enhanced overall light distribution on all surfaces using Kometa.

How to specify Kometa

- What ceiling type is going to be used?
- Is it going to be a suspended ceiling or solid ceiling?
- If it is a suspended ceiling will it be grid or plaster board?
- If it is a grid, what type? e.g. 15mm exposed Grid; 24mm exposed Grid, Semi Concealed Grid, Concealed Grid or Metal Plank?
- What material will the tiles be? e.g. Metal, Fibre or other?
- Who is the ceiling manufacturer?
- If the manufacturer is known is a range or reference available?
- If the ceiling type is known is a cross sectional drawing or sample available?
- Is the ceiling void depth known?
- Is the height of the grid system T bars known?
- Does the Kometa tile need to match any features of the ceiling system? e.g. paint finish, perforation, tile edge detail?

Equilibro Central MPD

- Recessed 600 x 600 direct/indirect lighting solution
- Decorative screen with micro perforated diffuser (MPD) for visual comfort
- High performance
- Ideal for open-plan offices, executive offices, meeting rooms, technical offices, halls, specialised stores, department stores and banks
- A2 ballasts
- **Rapid versions supplied complete with lamps**

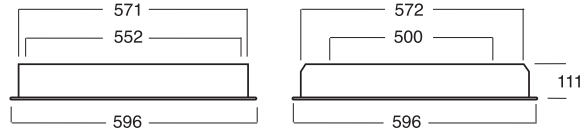

Standard Order lamps separately

	Emergency		
2 x 36w TC-L		0058832	6.10kg
2 x 36w TC-L	Integral	0058855	7.10kg
2 x 55w TC-LE		0058834	5.30kg
2 x 55w TC-LE	Integral	0058856	6.30kg

Note: Emergency modules are 3 hour maintained

Rapid Supplied with lamps

2 x 36w TC-L	0058838	6.10kg
2 x 55w TC-LE	0058842	5.30kg

2 x 36w TC-L

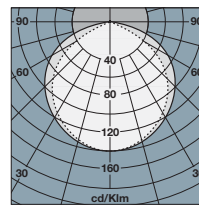

DLOR: 0.45

Lynx-L 36W-2G11
Lynx-LE 55W-2G11



36 W = 2900 lm
55 W = 4800 lm

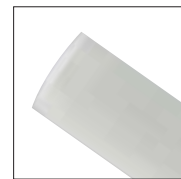

White coated microperforated diffuser (MPD) with internal polycarbonate foil for visual comfort

Equilibro Bess 4

- T5/T16 2x24 Watts
- Recessed direct and indirect
- 600x600 lay-in module
- Very low brightness
- Ideal for open-plan offices, executive offices, meeting rooms, technical offices, halls, specialised stores, department stores and banks
- Bess 4 high performance louvre
- Visual comfort

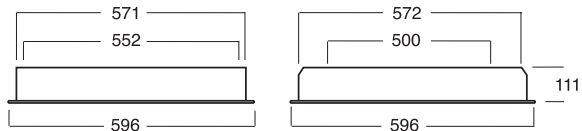

	Emergency		
2 x 24w T16		0058870	6.10kg
2 x 24w T16	Integral	0058871	7.10kg

Screen description:

White coated body and perforated screen with internal polycarbonate foil. Combined with Specular Bess 4 high performance aluminium louvre.

2 x 24w T16

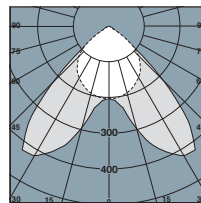

Luxline Plus FHO Ø 16

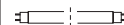

24 W = 2000 lm

3.4.T5

- Lower energy consumption
- Higher lumen package
- Longer lamp life
- Increased environmental consciousness
- Bess 4 patented concave and convex V-lamella reflectors provide very low brightness at all critical angles
- Top quality components
- Sylvania lamps
- Rapid version
- No need to remove lamps or louvers to install
- A "peel off" film protects the louvers during installation
- Satin aluminium tri-dimensional optic
- LOR = 66% UTE= 0,66B
- 500 cd/m2 at = 65°
- **Supplied with 840 lamp**



Emergency			
3 x 14w T16		5055756	4.60kg
3 x 14w T16	Integral	2638502	5.60kg
4 x 14w T16		5055757	5.00kg
4 x 14w T16	Integral	2638503	6.00kg

Pull-up accessories

Side arm fixation set	5055762
-----------------------	----------------

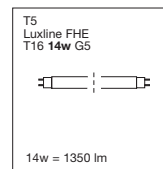
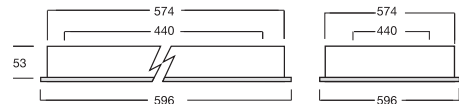
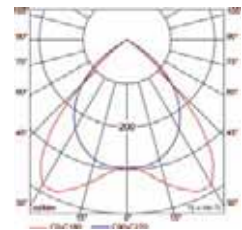
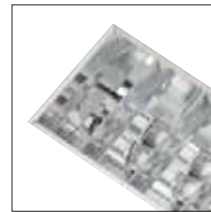

- Protection to IP65 - for additional weather and chemical resistance, please refer to Sylproof CAP 2
- High impact resistant polycarbonate housing with stainless steel mounting and diffuser retaining clips
- Polycarbonate injection moulded linear prism diffuser and frosted upper layer optimises output and control glare
- New push/push clips for convenient access to gear tray
- Available with magnetic (T8) or energy efficient electronic control gear
- T8 and T5 lamp choices
- Electronic control gear for emergency versions supplied as standard
- Applications include covered car parks, storage and many industrial areas
- Ceiling mounted with snap-on brackets or surface mounted



T8	Magnetic gear (B2) NC ¹⁾	PC ²⁾	Electronic control control gear (A2)	Electronic control control gear (A1) Analogue dimmable (1-10v)	Electronic control control gear (A2) with Fuse (3A) ⁴⁾	Electronic control control gear (A2) Emergency ³⁾ 1hr duration 3h duration	
1 x 18w T26	0045690	0045715	0045763	–	0045917	–	–
1 x 36w T26	0045691	0045716	0045764	0045772	0045918	0045781	0045777
1 x 58w T26	0045692	0045717	0045765	0045773	0045919	0045782	0045778
2 x 36w T26	0045693	0045718	0045766	0045774	–	0045783	0045779
2 x 58w T26	0045694	0045719	0045767	0045775	–	0045784	0045780

T5	Electronic control control gear (A2)	Electronic control control gear (A1) Analogue dimmable (1-10v)	Electronic control control gear (A2) Emergency ³⁾ 1hr duration 3h duration	
1 x 28w T16	0045806	–	–	–
1 x 35w T16	0045807	–	–	–
1 x 54w T16	0045808	–	–	–
2 x 28w T16	0045800	0045812	0045816	0045804
2 x 35w T16	0045801	0045813	0045817	0045805

- 1) Non compensated
 2) Parallel compensated
 3) On 2 lamp versions - 1 lamp with emergency
 4) Fused terminal block

Supply: 240v/50Hz
 Temperature: -20°C* to + 25°C with magnetic ballast
 0° to 25°C with electronic control gear
 Connection: 3-way automatic terminal block (for cross sections up to 2.5mm²)
 Reflector: Steel, powder coated white
 Diffuser: Polycarbonate, clear with internal linear prisms
 polyurethane surrounding seal
 Clips: Stainless steel
 Housing: Injection moulded polycarbonate
 grey RAL 7035, injected gasket

*Not in continuous use

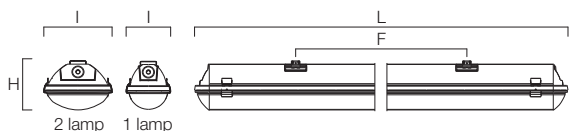

Dimensions

Wattages	L (mm)	I (mm)	H (mm)	F (mm)	Weight (kg)	
					Magnetic gear (B2)	Electronic gear
1 x 18	668	94	104	340	1.7	1.6
1 x 36/28/54	1276	94	104	850	2.5	2.2
1 x 58/35	1576	94	104	850	3.4	2.7
2 x 28	1276	94	104	850		2.2
2 x 35	1576	94	104	850		2.7
2 x 36	1276	144	106	850	3.9	3.3
2 x 58	1576	144	106	850	5.4	5.9

T5 (Ø16mm) lamp versions in 1 lamp body size

T8
Luxline Plus
T26 18/36/58w G13

18w = 1350 lm
36w = 3350 lm
58w = 5200 lm

T5
Luxline FHE
T16 28/35w G5

28w = 2640 lm
35w = 3300 lm

T5
Luxline FHO
T16 54w G5

54w = 4450 lm

Sylwing R

- Lay-in or pull-up – fits both 15mm and 25mm T grids
- LOR 82% Bess 4 tri-dimensional optic louvre back-lamp reflector and polynomial profile louvre optimise intensity distribution and output
- Bess 4 patented concave and convex V-lamella reflectors provide very low brightness at all critical angles
- Micro perforated separation panels and frame, retained by wishbone springs providing permanent earth and hinge for maintenance
- Rapid installation, fast fit connections on rear of housing
- Supplied complete with T5 3000°K high efficiency triphosphor lamps
- Emergency versions as standard



	Emergency	White	
3 x 14w T16		0054709	4.00kg
3 x 14w T16	Integral	0054442	5.30kg
4 x 14w T16		0054710	4.00kg
4 x 14w T16	Integral	0054443	5.30kg

Accessory Order separately

Set x 4 Side Arm	5052328	0.50kg
------------------	----------------	--------

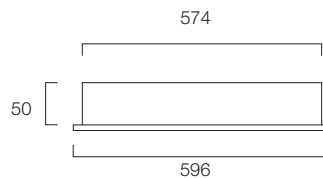

- Control Gear: Integral electronic ballast
 Emergency: Integral, 3hr maintained
 Connection: Fast fit connections on rear of housing
 Standard: 3 way terminal block
 Emergency: 5 way terminal block
 Reflector: Bess 4 specular aluminium, removable protective film
 Housing: Steel, micro perforated panels and frame, powder coated white
 Side Arms: Steel

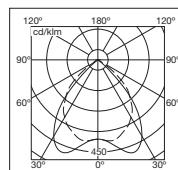

DLOR = 0.82 0054709

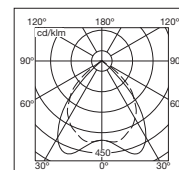

DLOR = 0.82 0054710

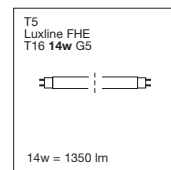

Fast fit connections

Sylpack 2

- Lay-in or pull-up
- Rigid one-piece housing fits both 15mm and 25mm T grids
- Choice of high output, low brightness louvre or low brightness comfort prismatic controller
- Visual 60 specular anodised louvre retained by wishbone springs
- Flush framed prismatic diffuser hinges for lamp maintenance
- Rapide Visual 60 version designed for fast installation – supplied complete with T8 3000°K triphosphor lamps, external fast fit electrical connection, housing safety cable and Visual 60 louvre assembled with removable protective sleeve



Visual 60 Louvre



Comfort Prismatic Diffuser



Sylpack 2 with Visual 60 Louvre

	Emergency	White	
3 x 18w T26		0058490	4.30kg
3 x 18w T26	Integral	0058494	5.10kg
4 x 18w T26		0058540	4.70kg
4 x 18w T26	Integral	0058495	5.50kg

Sylpack 2 with Comfort Prismatic Diffuser

3 x 18w T26		0057350	4.90kg
3 x 18w T26	Integral	0057352	5.70kg
4 x 18w T26		0057351	4.90kg
4 x 18w T26	Integral	0057353	5.70kg

Sylpack 2 Rapide with Visual 60 Louvre

3 x 18w T26		0058496	4.30kg
3 x 18w T26	Integral	0058498	5.10kg
4 x 18w T26		0058497	4.70kg
4 x 18w T26	Integral	0058499	5.50kg

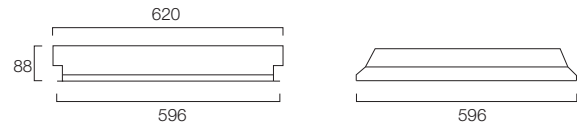

- Control Gear: Integral electronic ballast
- Emergency: Integral, 3hr maintained
- Louvre: Visual 60: Specular anodised aluminium retained by torsion springs with permanent earth connection
Rapide: As visual 60 plus removable protection film
- Diffuser: One piece steel frame powder coated white, flame retardant prismatic diffuser, retained by torsion springs with permanent earth connection
- Connection: Standard: 3 way terminal block
Emergency: 5 way terminal block
Rapide: Fast fit external entry – 3 way standard or 5 way emergency
- Housing: Steel, powder coated white
- Security Cable: Rapide: Pull-up stainless steel wire retention cable

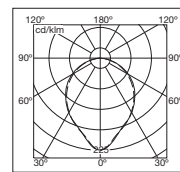

DLOR = 0.51 0057351

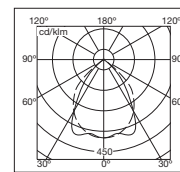

DLOR = 0.59 0058540

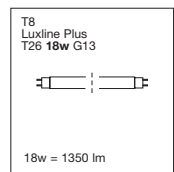

Rapide Connector



Ovation 65

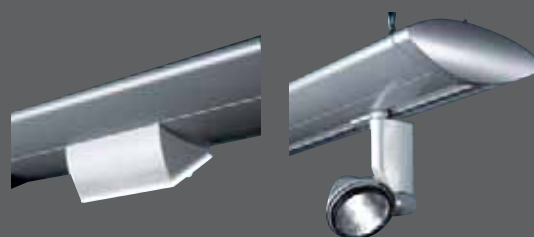

- Fluorescent, Linear T5 direct / indirect and accent lighting
- All modules are interchangeable for maximum flexibility
- Low glare and low brightness controllers for minimal glare
- Contoured louvres maintain the oval profile of the modules
- Track modules accept Concord:marlin single circuit spotlights
- Rapid installation with optional plug and socket arrangement
- Digital dimmable Switch Dim and DSI compatible modules as standard
- A sleek tapered end cap to enhance the overall profile of the module
- Tapered end cap and dummy module options available with PIR occupancy and daylight management sensors
- Non maintained 3hr emergency module housing 2 x 1W 60° LED's
- T5 and CMI/CDM-T adjustable flood modules for retail and accent display lighting
- Direct only versions available with optional back plate



Control Gear:	Standard: integral electronic
Dimmable:	Digital dimmable PCA ECO Switch Dim and DSI compatible
Emergency:	Integral 3hr maintained Integral 3hr non maintained 2x1W 60° LED module
Connection:	Through wiring with 10A cables to five way terminal blocks
Reflector / Louvre:	Super pure aluminium, specular
Diffuser:	Direct: clear or opal prismatic Indirect: prismatic
Housing:	Extruded aluminium powder coated white RAL 9016 or silver RAL 9006
Track:	PVC carrier with copper power conductors
Adjustable flood and Asymmetric modules:	Extruded aluminium powder coated white RAL 9016 or silver RAL 9006 with aluminium reflectors

Ovation 65

T16 Modules

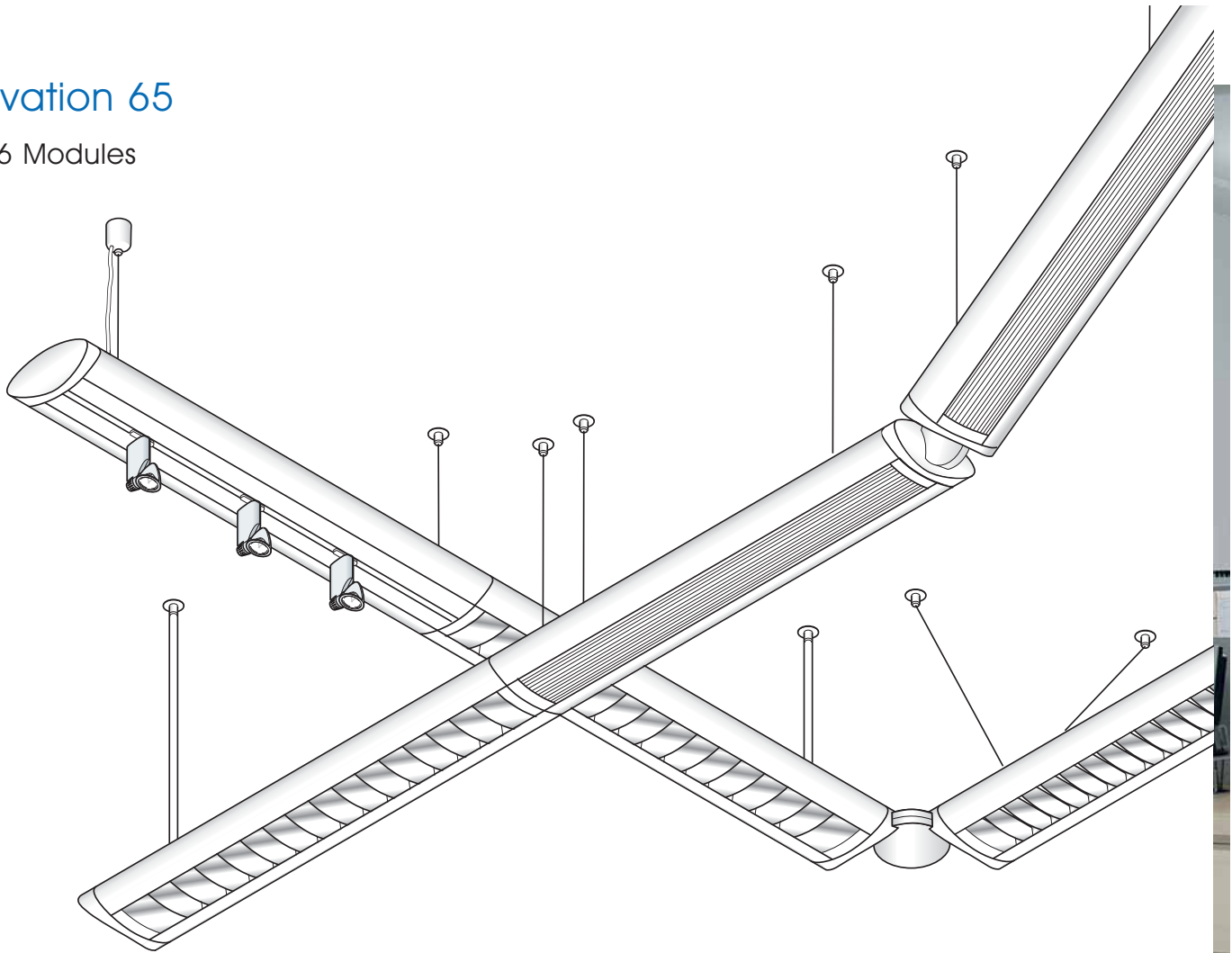

Direct/Indirect Module Supplied c/w Rear Prismatic Controller

	Length	Standard			Emergency		
		White	Silver		White	Silver	
1 x 28w T16	1240mm	2034214	2034216	4.10kg	2034304	2034306	4.95kg
1 x 35w T16	1540mm	2034215	2034217	5.00kg	2034305	2034307	5.85kg
2 x 28w T16	1240mm	2034223	2034225	4.10kg	2034313	2034315	4.95kg
2 x 35w T16	1540mm	2034224	2034226	5.00kg	2034314	2034316	5.85kg
1 x 54w T16	1240mm	2034218	2034221	4.10kg	2034308	2034311	4.95kg
1 x 80w T16	1540mm	2034220	2034222	5.00kg	2034310	2034312	5.85kg
2 x 54w T16	1240mm	2034227	2034230	4.10kg	2034317	2034320	4.95kg
2 x 80w T16	1540mm	2034228	2034231	5.00kg	2034318	2034321	5.85kg

NOTE: Order louvre/diffuser, end caps and suspensions separately

Direct/Indirect Module Digital Dimmable. Supplied c/w Rear Prismatic Controller

	Length	Standard			Emergency		
		White	Silver		White	Silver	
1 x 28w T16	1240mm	2038210	2038212	4.10kg	2038236	2038238	4.95kg
1 x 35w T16	1540mm	2038211	2038213	5.00kg	2038237	2038240	5.85kg
2 x 28w T16	1240mm	2038218	2038221	4.10kg	2038245	2038247	4.95kg
2 x 35w T16	1540mm	2038220	2038222	5.00kg	2038246	2038248	5.85kg
1 x 54w T16	1240mm	2038214	2038216	4.10kg	2038241	2038243	4.95kg
1 x 80w T16	1540mm	2038215	2038217	5.00kg	2038242	2038244	5.85kg
2 x 54w T16	1240mm	2038223	2038225	4.10kg	2038250	2038252	4.95kg

NOTE: Order louvre/diffuser, end caps and suspensions separately

Back Plate (Converts direct/indirect to direct only)

	Length	Standard		
		White	Silver	
28/54w	1240mm	2038205	2038206	1.50kg
35/80w	1540mm	2038207	2038208	2.00kg

For areas which require direct light only use solid back plate

Louvres/Controllers

Low Brightness Louvre

LG3			
28w/54w	1000		9129180
35w/80w	1000		9129181

Low Glare Louvre

Single/Twin			
28w	200/500		9129182
35w	200/500		9129183

Clear Prismatic Controller

28w/54w	2034282
35w/80w	2034283

Opal Prismatic Diffuser

28w/54w	2034284
35w/80w	2034285

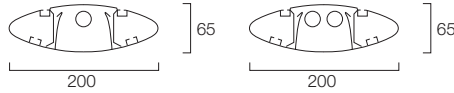

T5
Luxline FHE
T16 28/35w G5

28w = 2640 lm
35w = 3300 lm

T5
Luxline FHO
T16 54/80w G5

54w = 4450 lm
80w = 6150 lm

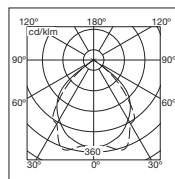

DLOR = 0.65
2034226 + 2038206
+ 9129181

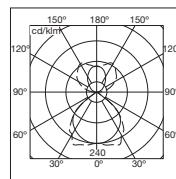

DLOR = 0.43 ULOR = 0.36
2034226 + 9129181

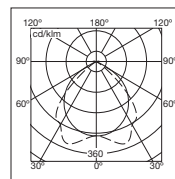

DLOR = 0.64
2034226 + 2038206
+ 9129183

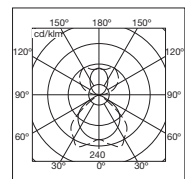

DLOR = 0.41 ULOR = 0.36
2034226 + 9129183

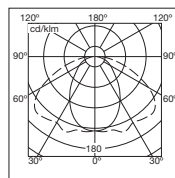

DLOR = 0.49
2034226 + 2038206
+ 2034283

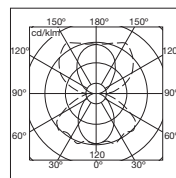

DLOR = 0.34 ULOR = 0.36
2034226 + 2034283

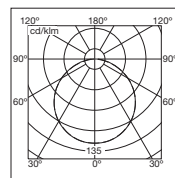

DLOR = 0.28
2034226 + 2038206
+ 2034285

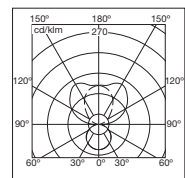

DLOR = 0.22 ULOR = 0.40
2034226 + 2034285

Ovation 65

T16 Modules



Indirect Module with Single Circuit Track

Supplied c/w rear prismatic controller and Lytespan 1 track (10A max)
Use with any Concord:marlin single circuit spotlight

	Length	White	Silver	
2 x 28w T16	1240mm	2034232	2034234	4.50kg
2 x 35w T16	1540mm	2034233	2034235	5.50kg
2 x 54w T16	1240mm	2034236	2034238	4.50kg

NOTE: Order end caps and suspensions separately

Indirect Digital dimmable Module with Single Circuit Track

Supplied c/w Lytespan 1 track (10A max)

	Length	White	Silver	
2 x 28w T16	1240mm	2038227	2038230	4.50kg
2 x 35w T16	1540mm	2038228	2038231	5.50kg
2 x 54w T16	1240mm	2038232	2038234	4.50kg

NOTE: Order end caps and suspensions separately

Track Module with Single Circuit Track

Supplied c/w Lytespan 1 track (10A max)

Use with any Concord:marlin single circuit spotlight

	Length	White	Silver	
	1240mm	2034241	2034243	4.52kg
	1540mm	2034242	2034244	5.65kg

NOTE: Order end caps and suspensions separately

Direct Asymmetric Module

Complete with asymmetric aluminium reflector with profiled cross blades

	Length	White	Silver	
1 x 28w T16	1240mm	2034245	2034247	4.50kg
1 x 35w T16	1540mm	2034246	2034248	5.50kg

NOTE: Order end caps and suspensions separately

T5 Adjustable Flood Modules

	Length	White	Silver	
1 x 28w T16	1240mm	2038303	2038304	4.50kg
1 x 35w T16	1540mm	2038305	2038306	5.50kg

NOTE: Order end caps and suspensions separately

CMI/CDM-T Adjustable Flood Modules

	Length	White	Silver	
1 x 35w HIT-CE	620mm	2038968	2038970	3.35kg
1 x 70w HIT-CE	620mm	2038971	2038972	3.35kg

NOTE: Order end caps and suspensions separately

Dummy Module

Removable back cover. Variant lengths must be cut by Concord:marlin

	Length	White	Silver	
	1240mm	2034254	2034256	4.12kg
	1540mm	2034255	2034257	5.15kg
	620mm	2038196	2038197	2.50kg

NOTE: Order end caps and suspensions separately

Emergency LED Module

2 x 1w LED	620mm	2038194	2038195	2.30kg
------------	-------	----------------	----------------	--------

NOTE: Order end caps and suspensions separately

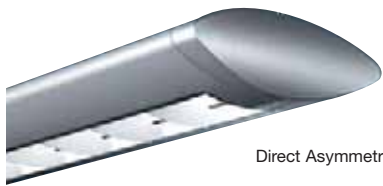

Direct Asymmetric Module

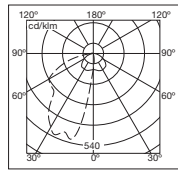

DLOR = 0.65
2034248

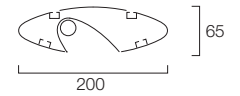
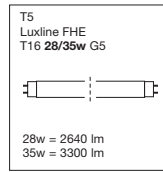

Direct Asymmetric Module



Indirect Module with Single Circuit Track

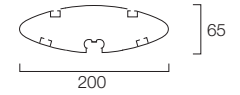
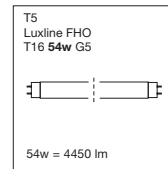
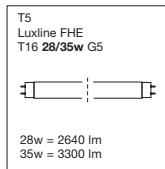

Indirect Module with Single Circuit Track



Adjustable CMI/CDM-T Flood Module

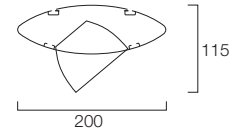
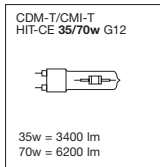

Adjustable Flood Downlight



T5 Adjustable Flood Module

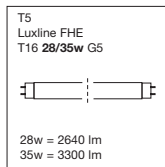

Emergency LED Module

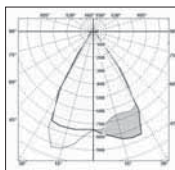

2038195

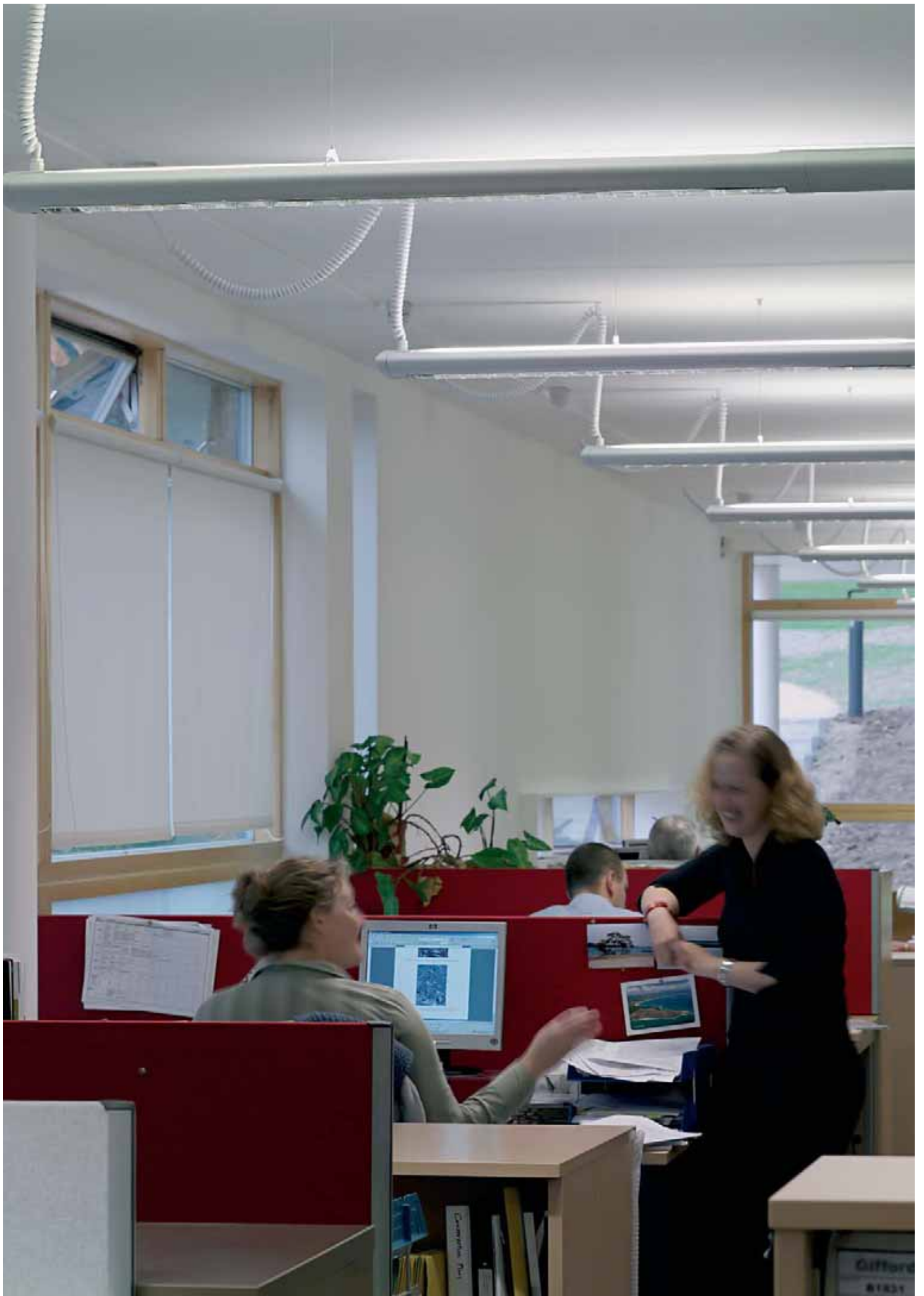

Ovation 65

DSI-SMART System

- DSI-SMART provides a simple yet effective means of controlling luminaires independently
- Based on PIR occupancy sensing and ambient light measurement
- The artificial light is regulated so the ambient light (artificial + natural light) remains constant
- Reduction in energy use and operation costs
- Programming of functions is made by the SMART-Programmer without the need to access the luminaire or DSI-SMART sensor
- All adjustments and settings are made via infra-red hand held remote control
- DSI-SMART amplifier available on request allows for the control of up to 20 modules
- **Each sensor can control up to a maximum of 4 modules**
- **For use with digitally dimmable modules only**



Basic components required for an Ovation 65 DSI-Smart System

- 1 **Digitally Dimmable Modules.** Order separately (see pages 26-29)
- 2 **DSI-SMART Sensor Module or End cap.** Order a programmer and controller separately



	Length	white	silver	weight
DSI-SMART Dummy Module	620mm	2038198	2038200	2.5kg
DSI-SMART Tapered End Cap	120mm	2038203	2038204	0.75kg

- 3 **DSI-SMART Programmer & Controller.** Order both in addition to sensors and digitally dimmable modules



DSI-SMART Programmer

One per installation **9139060**

DSI-SMART Controller

Infra Red control for multiple sensors **9139061**

Ovation 65

Connectors



X Coupler



Vertical Adjustable Corner

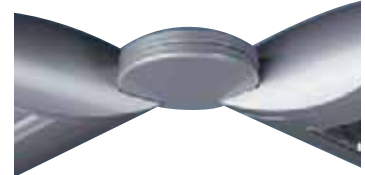

Corner Pivot

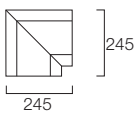

L Coupler

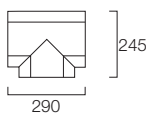

T Coupler

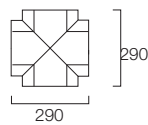

X Coupler

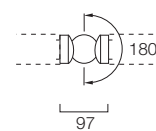
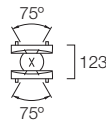

Centre Pivot



Corner Pivot



Flat End Cap



Tapered End Cap



Rapid Connector

Couplers For module to module connection

Concealed Straight Coupler – pack of 4 splines	2034276		
	White	Silver	
L Coupler	2034261	2034262	1.05kg
T Coupler	2034263	2034264	1.15kg
X Coupler	2034265	2034277	1.25kg

Supplied c/w Concealed Straight Couplers

Adjustable Corners Through wired	Length	White	Silver	
Vertical	97mm	2034270	2034271	0.47kg
Horizontal Corner Pivot		2034266	2034267	0.65kg
Horizontal Centre Pivot		2034322	2034323	0.65kg

Flat End Caps Supplied as singles	Length	White	Silver	
	25mm	2034272	2034273	0.18kg

Tapered End Caps Supplied as singles	Length	White	Silver	
	120mm	2038201	2038202	0.75kg

Rapid connectors	Length		
	54mm	2039062	

Ovation 65

Suspensions

- Suspensions supplied in either mechanical or mechanical/electrical versions
- Mechanical/electrical versions have hidden cable entry for mains supply
- Mechanical/electrical supplied with 5 way mains cable
- **Minimum of 2 suspensions per module. Max load 15kg**



Wall Bracket



Rod Suspension Electrical/Mechanical



Rod Suspension Mechanical



Wire Suspension

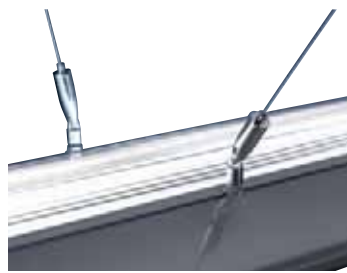

Pivoting Suspension Cables

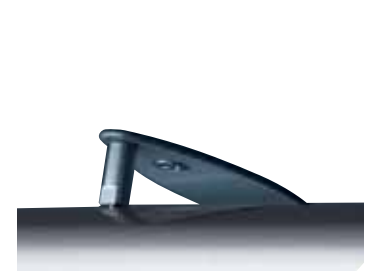

Ceiling Bracket

Rod Suspension Supplied as singles

Can be modified on site. Can be cut from the ceiling end

	Length	White	Silver
Mechanical	500mm	2032344	2032345
Mechanical	1000mm	2032320	2032321
Mechanical/electrical	500mm	2032342	2032343
Mechanical/electrical	1000mm	2032317	2032318

Wire Suspension Supplied as singles

Can be modified on site. Longer lengths available to special order

	Length	White	Nickel	Silver
Mechanical	3000mm	-	2038193	-
Mechanical/electrical	3000mm	2032322	-	2032323

Wall Bracket Supplied as singles

Can be modified on site. Longer lengths available to special order

	Outreach	White	Silver
Mechanical	500mm	2032331	2032334
Mechanical	1000mm	2032333	2032336
Mechanical/electrical	500mm	2032324	2032327
Mechanical/electrical	1000mm	2032326	2032330

Pivoting Suspension Cables Supplied as pairs

Can be modified on site. Longer lengths available to special order

	Length	
Mechanical	3000mm	2034268

Ceiling Bracket Supplied as singles

Not suitable for use with indirect modules

	White	Silver
Mechanical	9129175	9129176

Indirect

- All versions supplied with integral safety glass *except 42w
- Edge lit frosted glass on TC-TEL version adds a decorative quality
- Auxiliary lamp option provides instant light at switch-on or following temporary power interruption
- Choice of indirect or direct/indirect lighting performance



Indirect with Standard Integral Safety Glass		White
42w TC-TEL*	4041642	2.45kg
200/500w QT-DE12	4041643	3.25kg
70w HIT-DE-CE	4041638	4.20kg
70w HIT-DE-CE with QT18 Aux lampholder	4041639	4.30kg
150w HIT-DE-CE	4041640	4.70kg
150w HIT-DE-CE with QT18 Aux lampholder	4041641	4.80kg

Indirect with Edge Lit Frosted Deco Glass		White
42w TC-TEL	4042725	3.75kg

NOTE: Allow 500mm minimum distance between top of fitting and combustible surface

Control Gear: TC-TEL: Integral electronic gear
 HIT-DE-CE: Integral ballast HPF

Reflector: QT-DE/HIT-DE-CE: Aluminium, specular hammer effect

Safety Glass: QT-DE/HIT-DE-CE: Borosilicate

Deco Glass: TC-TEL: Toughened, frosted

Housing: Die cast aluminum, powder coated white RAL 9016



Indirect with Standard Integral Safety Glass



Indirect with Edge Lit Frosted Safety Glass

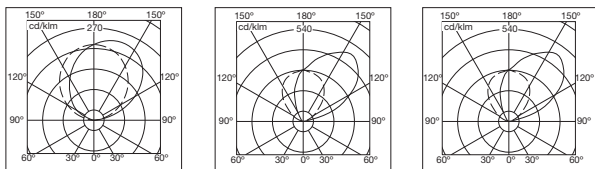

ULOR = 0.61
4041642

ULOR = 0.82
4041643

ULOR = 0.82
4041638

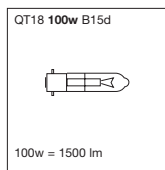
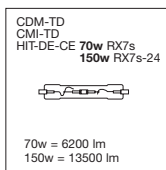
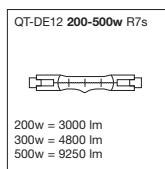
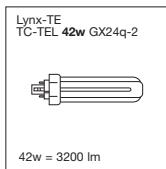

Auxiliary lamp

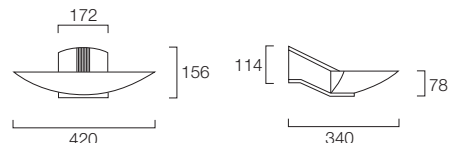

Integral Safety Glass

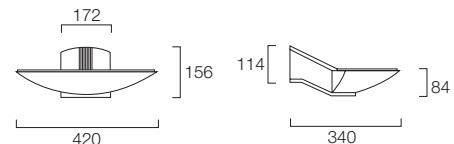

Edge Lit Safety Glass

Triangle

Indirect

- Asymmetric indirect light distribution
- Choice of two sizes and four lamp types
- Tungsten Halogen option easily dimmed
- Supplied with toughened UV blocking safety glass



Triangle	White	
200/300w QT-DE	4065881	3.40kg
70w HIT-DE	4065882	5.40kg
150w HIT-DE	4065883	5.70kg

Triangle Large	White	
250w HIT-DE	4065884	10.70kg

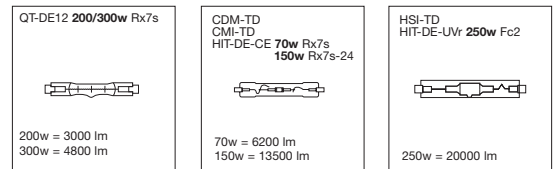

Control Gear: HIT-DE: Integral 230-230v, HPF capacitor circuit
 Reflector: MICRO 9 embossed bright finish
 Safety Glass: Toughened glass UV white
 Housing: Aluminium RAL 9010 white

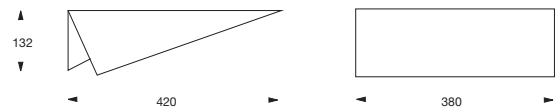
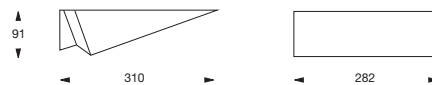

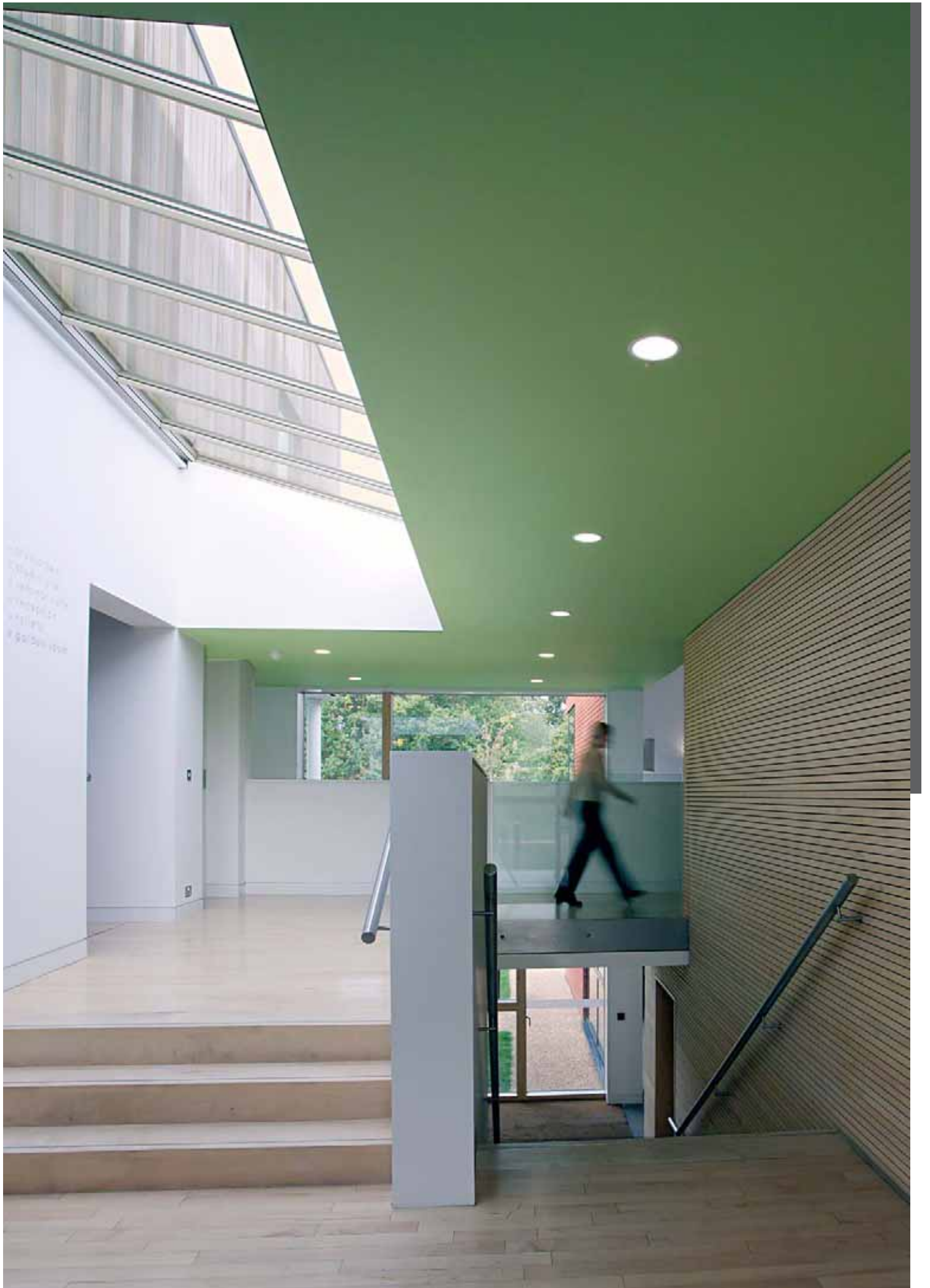

LED 100-TE

Installation Sequence



1 Remove reflector using gloves provided.



2 Compress retaining clips and remove from luminaire housing.



3 If an Architectural accessory is to be fitted, place accessory ring over luminaire and locate on rim with the 'up' sticker in the 'up' position.



4 Wire luminaire and pass through ceiling cut out.



Architectural



5 Insert ceiling clips according to ceiling thickness. (1-25mm)



6 Replace reflector using gloves provided.



7 Insert lamp while lampholder is in the tilted position.



8 Push lamp into position until lampholder 'clicks' into place.



Deco

Applications

- Reception Areas
- Corridors
- Washrooms
- Merchandise Displays
- Under canopy lighting



Eco

- Compact fluorescent luminaire
- Tilting lampholder for easier re-lamping
- Simple to install retaining clips
- Suitable for ceilings 1-25mm in thickness
- Recess depth of just 100mm
- High LORs up to 75%
- Super efficient HF electronic gear
- Small ceiling apertures of 120mm and 160mm
- Emergency options can be installed from below the ceiling
- 160mm luminaire will accept either 32/42w TC-TEL or 26w TC-DEL lamps
- Suitable for use with a wide range of lighting controls
- Intumescent fire hoods available

Control Gear:	Integral electronic gear
Dimming Options:	26/42w 1-10v analogue dimming
Gear Tray:	Integral, polycarbonate
Emergency:	Remote, 3hr maintained
Connection:	Standard: 3 way terminal block Emergency: 9 way plug and socket
Reflector:	Spun aluminium, specular (Eco white painted)
Housing:	Die-cast aluminium finished white RAL 9016
Accessories:	Architectural: Die cast aluminium and glass construction Deco: Polycarbonate

LED 100-TE

Architectural

- Recess depth of 100mm
- Full depth silver reflector
- Tilting lampholder for easier re-lamping
- Die-cast housing with integral polycarbonate gear
- Wide range of decorative glass accessories and die-cast bezels
- For gold reflector and cross blade louvre versions see page 44
- Dimming and emergency versions as standard



120mmØ	HF	1-10v Dimmable	Emergency	Emergency Dimmable		
1 x 13w TC-TEL	2028019	-	0.65kg	2028020	-	2.25kg
1 x 18w TC-TEL	2028021	-	0.65kg	2028022	-	2.25kg
1 x 26w TC-TEL	2028023	2030718	0.65kg	2028024	2030731	2.25kg

120mmØ Accessories	Order separately	White	Silver	
Bezel only		2028613	2028037	0.09kg
Clear Glass IP44 Cover		2028033	2028599	0.15kg
Etched Glass IP44 Cover		2028035	2028601	0.15kg
Polycarbonate IP54 Cover		2039012	-	0.13kg
Floating Glass Ring Blue Gel		2038983	-	0.40kg
Floating Profile Cut Glass Disc		2039020	-	0.45kg
Floating Glass Disc Fully Etched		2028059	2028607	0.34kg
Floating Frosted Cylinder Blue Ring		-	2034492	0.16kg
Floating Frosted Cylinder Clear Ring		2028548	2028611	0.16kg

13/18/26w

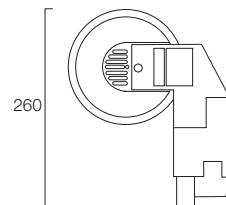
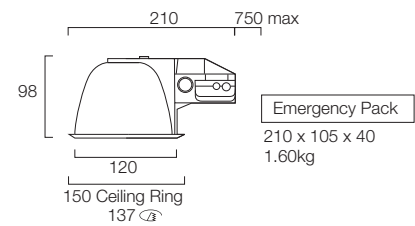

32/42w

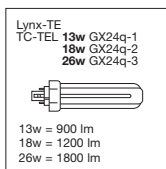
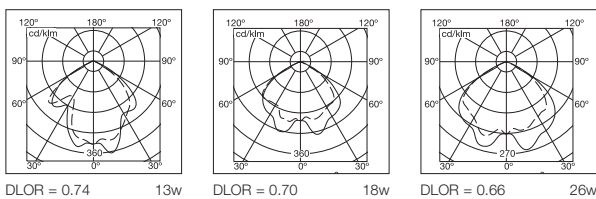
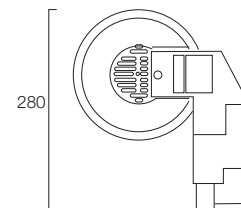
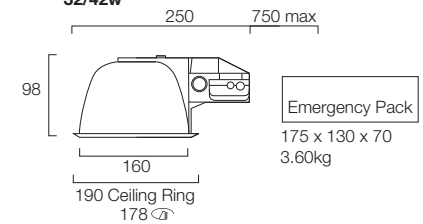

For a smaller aperture with vertically mounted compact fluorescent lamp, see Myriad Compact page 86.

LED 100-TE

Architectural

160mmØ	HF	1-10v Dimmable	Emergency	Emergency Dimmable	
1 x 32/42w TC-TEL*	2028027	2030716	0.75kg	2028028	2030717 4.35kg

* Will also accept 26w TC-DEL

160mmØ Accessories	Order separately	White	Silver	
Bezel only		2028614	2028038	0.11kg
Clear Glass IP44 Cover		2028034	2028600	0.20kg
Etched Glass IP44 Cover		2028036	2028602	0.20kg
Polycarbonate IP54 Cover		2039013	-	0.18kg
Floating Frosted Glass Ring		2038980	-	0.50kg
Floating Glass Ring Blue Gel		2038984	-	0.50kg
Floating Profile Cut Glass Disc		2039021	-	0.50kg
Floating Glass Disc Fully Etched		2028060	2028608	0.45kg
Floating Frosted Cylinder Blue Ring		2034493	2034494	0.21kg
Floating Frosted Cylinder Clear Ring		2028549	2028612	0.21kg

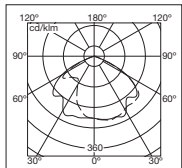

DLOR = 0.73 32w

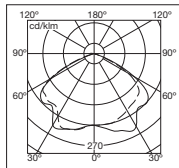

DLOR = 0.75 42w

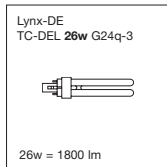
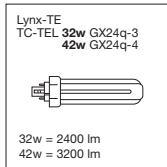

13/18/26w

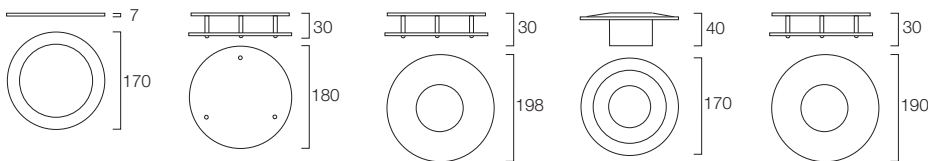

32/42w

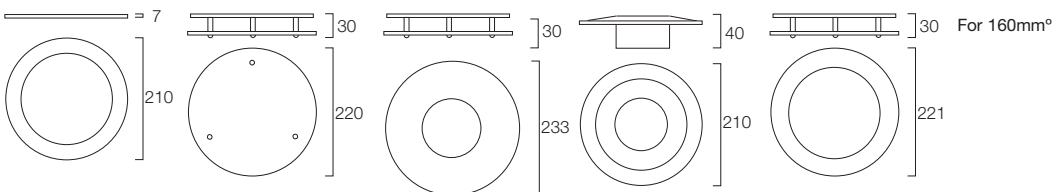

Clear Glass IP44 Cover



Polycarbonate IP54 Cover



Floating Frosted Glass Ring



Floating Glass Ring Blue Gel



Floating Glass Disc Fully Etched



Floating Profile Cut Glass Disc



Floating Frosted Cylinder Blue Ring

LED 100-TE

Deco

- Recess depth of 100mm
- Tilting lampholder eases re-lamping
- Die cast aluminium housing with integral polycarbonate gear box
- Accepts 'snap fit' polycarbonate accessories
- Super efficient electronic control gear
- Dimming and emergency versions as standard



	HF	1-10v Dimmable		Emergency	Emergency Dimmable	
1 x 13w TC-TEL	2028009	-	0.65kg	2028010	-	2.25kg
1 x 18w TC-TEL	2028011	-	0.65kg	2028012	-	2.25kg
1 x 26w TC-TEL	2028013	2030723	0.65kg	2028014	2030724	2.25kg

120mmØ Accessories Order separately

Opal Dropped Ring	2028047	0.03kg
Blue Dropped Ring	2028049	0.03kg
Etched Floating Disc IP44	2028051	0.13kg
Etched Floating Disc Blue Gel IP44	2028053	0.13kg
IP44 Clear	2028039	0.01kg
IP44 Opal	2028041	0.01kg
IP44 Prismatic	2028043	0.01kg
IP44 Wallwasher	2028045	0.01kg

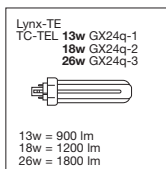
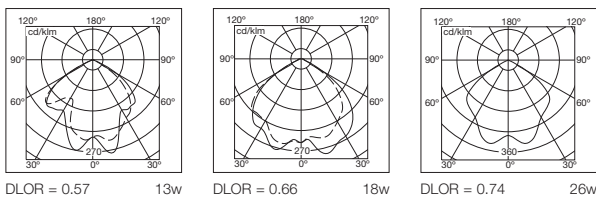

For a smaller aperture with vertically mounted compact fluorescent lamp, see Myriad Compact page 86.

13/18/26w

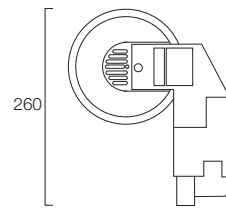
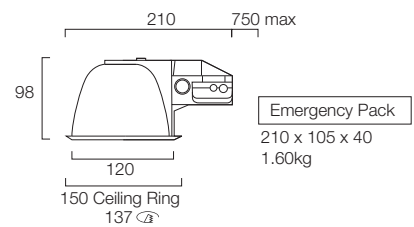

32/42w

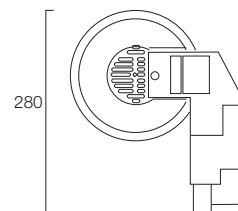
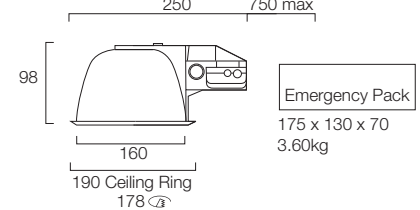

LED 100-TE

Deco



Opal Dropped Ring



Etched Floating Disc IP44



Blue Dropped Ring



Etched Floating Disc Blue Gel IP44

160mmØ	HF	1-10v Dimmable	Emergency	Emergency Dimmable	
1 x 32/42w TC-TEL*	2028017	2030721	0.75kg	2028018	2030722 4.35kg

* Will also accept 26w TC-DEL

160mmØ Accessories Order separately

Opal Dropped Ring	2028048	0.05kg
Blue Dropped Ring	2028050	0.05kg
Etched Floating Disc IP44	2028052	0.17kg
Etched Floating Disc Blue Gel IP44	2028054	0.17kg
IP44 Clear	2028040	0.03kg
IP44 Opal	2028042	0.03kg
IP44 Prismatic	2028044	0.03kg
IP44 Wallwasher	2028046	0.03kg



IP44 Clear



IP44 Opal

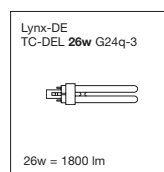
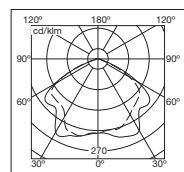
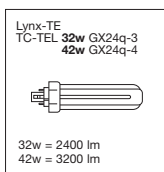
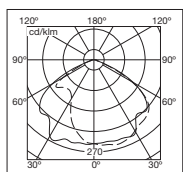

IP44 Prismatic

13/18/26w

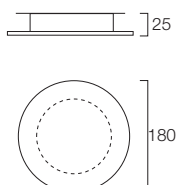
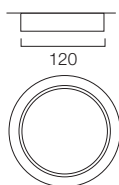

32/42w

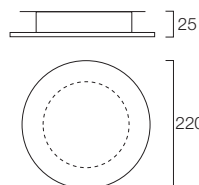
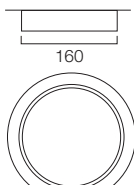

IP44 Wallwasher

LED 100-TE

Eco

- Standard non-accessory downlight
- Recess depth of 100mm
- White reflector
- Tilting lampholder eases re-lamping
- Die-cast housing with integral polycarbonate gear box
- Optional gold or cross blade louvre reflectors



120mmØ	HF	1-10v Dimmable	Emergency	Emergency Dimmable	
1 x 13w TC-TEL	2027999	–	0.65kg	2028000	– 2.25kg
1 x 18w TC-TEL	2028001	–	0.65kg	2028002	– 2.25kg
1 x 26w TC-TEL	2028003	2030727	0.65kg	2028004	2030728 2.25kg

120mmØ Optional Reflectors Order separately

Gold Reflector Deco	2028029	0.04kg
Gold Reflector Architectural	2028031	0.04kg
Cross Blade Louvre Reflector Assembly	2029861	0.06kg

Replace white reflector with either gold reflector or cross blade louvre

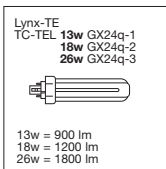
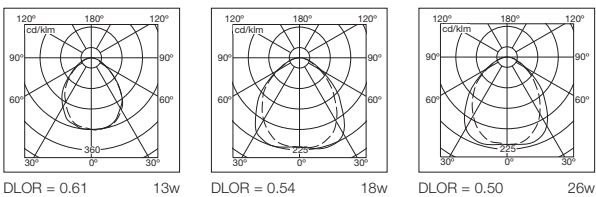

For a smaller aperture with vertically mounted compact fluorescent lamp, see Myriad Compact page 86.

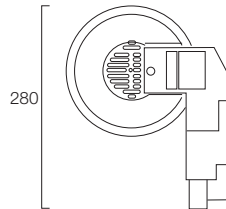
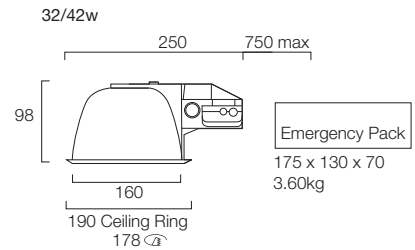
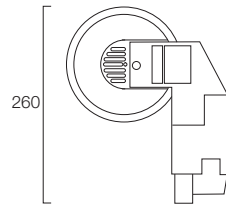
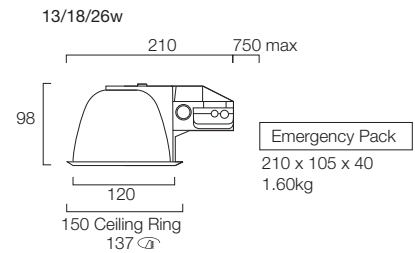

LED 100-TE

Eco



13/18/26w



32/42w

160mmØ	HF	1-10v Dimmable	Emergency	Emergency Dimmable	
1 x 32/42w TC-TEL*	2028007	2030725	0.75kg	2028008	2030726 4.35kg

* Will also accept 26w TC-DEL

160mmØ Optional Reflectors	Order separately	White
Gold Reflector Deco	2028030	0.08kg
Gold Reflector Architectural	2028032	0.08kg
Cross Blade Louvre Reflector Assembly	2029862	0.11kg

Replace white reflector with either gold reflector or cross blade louvre



Gold Reflector Architectural



Cross Blade Louvre

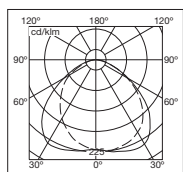

DLOR = 0.64 32w

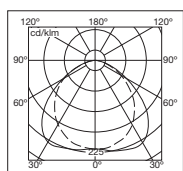
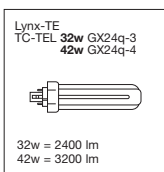

DLOR = 0.63 42w

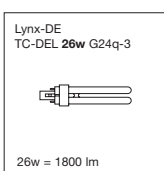

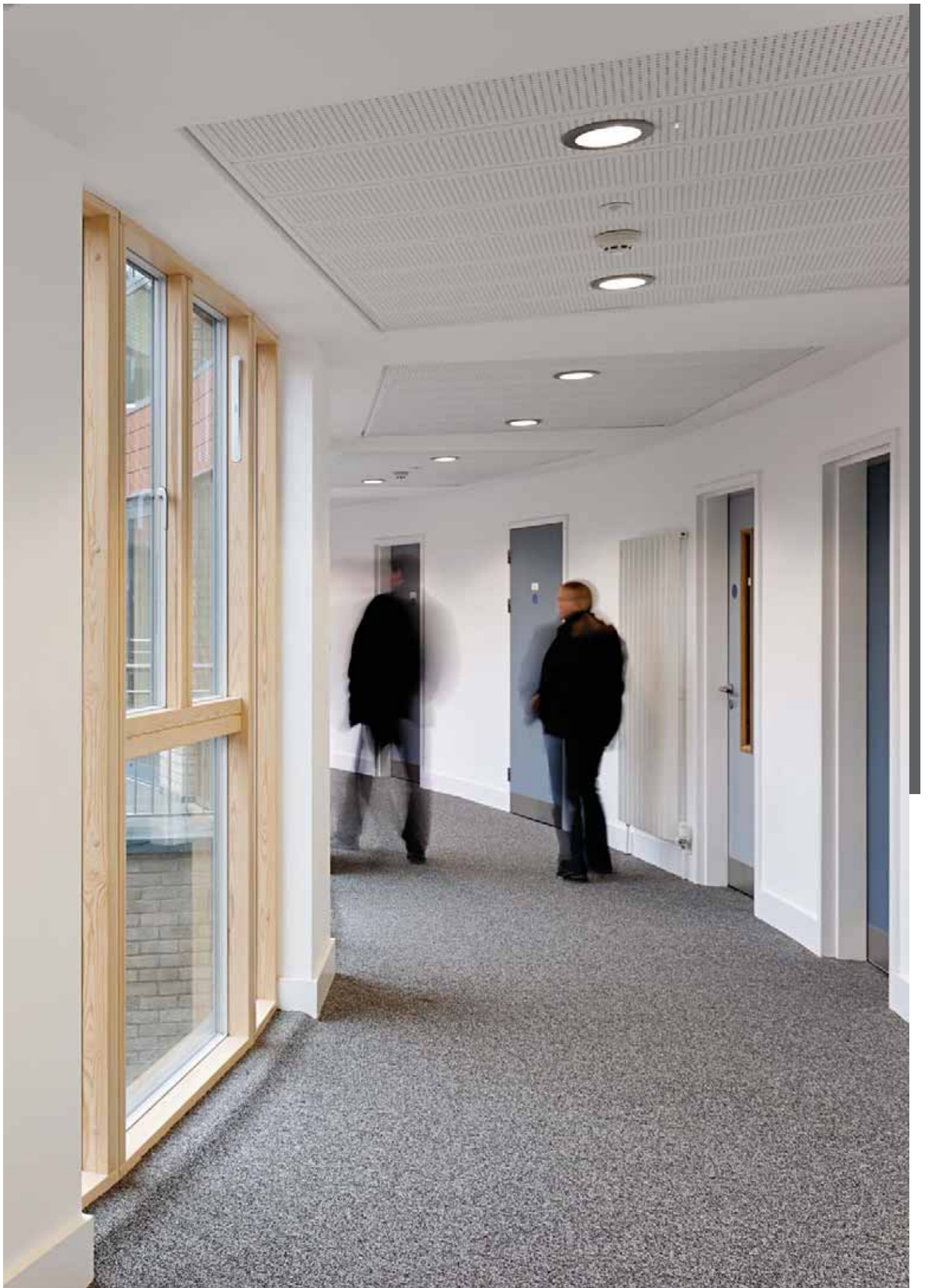

LED 150-TE

LED 150 Installation Sequence

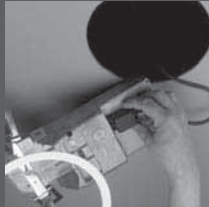

1 Plug and socket system for easy installation and 'loop in' – 'loop out' wiring

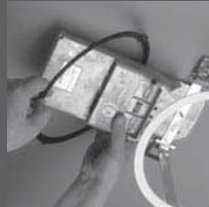

2 If luminaire is to be fitted with an accessory, place accessory ring over back of luminaire and locate on rear of trim

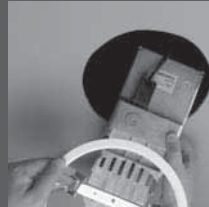

3 Insert luminaire into ceiling cut out locating using captive toggles on side



4 Insert reflector into housing frame using the gloves provided



5 Secure reflector with single knurled nut



6 Fit lamps and bayonet accessory if appropriate

Applications

- Entrance Halls
- Reception Areas
- Offices
- Board Rooms
- Meeting Areas
- Hospitals
- Schools

- Slimline ceiling trim of only 11mm
- High LOR's up to 79%
- Lightweight all metal construction with integral gear box
- HF electronic gear and 1-10v analogue dimmable options as standard
- Glare control to LG7 (incorporating LG3)
- 'Loop in' and 'loop out' plug and socket for easy installation
- Lampholders accept either TC-DEL or TC-TEL lamps
- Wallwasher apertures match corresponding downlights
- Suitable for ceilings 1-30mm in thickness
- Suitable for use with a wide range of lighting controls
- Intumescent fire hoods available

Control Gear:	Integral electronic gear
Dimming Options:	1-10v analogue dimming
Gear Tray:	Integral, die cast aluminium
Emergency:	Remote 3hr maintained
Connection:	Mains: 2 tier plug and socket Emergency: 9 way plug and socket
	Dimmable: 3 way mains/2 way 1-10 dimming terminal blocks
Reflector:	Spun aluminium Axial/Diamond Faceted: Vacuum metalised
Plaster Ring:	Lightweight alloy, finished white RAL 9016
Accessories:	Die cast aluminium bezels with metal supports, glass covers and rings (IP54 covers polycarbonate)

LED 150-TE II

160mmØ Bezel

- Slimline ceiling trim just 11mm
- All versions suitable for a wide range of accessories
- Aesthetic reflector choice



LED 150-TE II 160mm Ø Axial Faceted Reflector

160mmØ	HF	1-10v Dimmable	Emergency	Emergency Dimmable
1 x 18w TC-TEL/DEL	2038670	2038710	1.13kg	2038671 2038711 4.73kg
1 x 26w TC-TEL/DEL	2038672	2038712	1.13kg	2038673 2038713 4.73kg
2 x 13w TC-TEL/DEL	2038674	2038714	1.13kg	2038675 2038715 4.73kg

Diamond Faceted Reflector

160mmØ	HF	1-10v Dimmable	Emergency	Emergency Dimmable
1 x 18w TC-TEL/DEL	2038690	2038730	1.13kg	2038691 2038731 4.73kg
1 x 26w TC-TEL/DEL	2038692	2038732	1.13kg	2038693 2038733 4.73kg
2 x 13w TC-TEL/DEL	2038694	2038734	1.13kg	2038695 2038735 4.73kg

Emergency Gear Dimensions

175 x 130 x 70



Open Cone Diamond Faceted Reflector

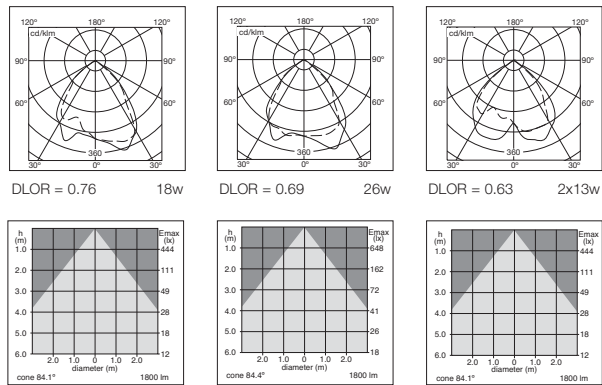
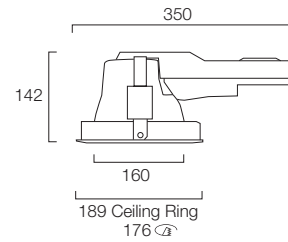

Lynx-TE
TC-TEL **13w** GX24q-1
18w GX24q-2
26w GX24q-3

13w = 900 lm
18w = 1200 lm
26w = 1800 lm

Lynx-D
TC-DEL **13w** G24d-1
18w G24d-2
26w G24d-3

13w = 900 lm
18w = 1200 lm
26w = 1800 lm

LED 150-TE II

160mmØ Wallwasher

- Specular smooth reflector
- Even ceiling to wall illumination
- Ideal for reducing 'cavern effect'

Specular Reflector

160mmØ	HF	
2 x 13w TC-TEL	2038750	1.05kg

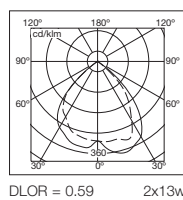

Lynx-TE
TC-TEL **13w** GX24q-1

13w = 900 lm

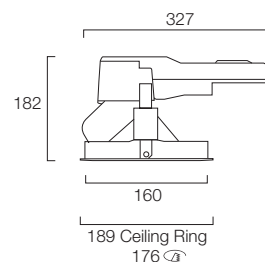

LED 150-TE II

160mmØ Accessories



Silver Bezel



White Bezel + IP54 Vandal Resistant Cover



White Bezel + IP44 Glass Cover



Floating Profile Cut Glass Disc



Floating Frosted Glass Ring



Floating Glass Ring Blue Gel

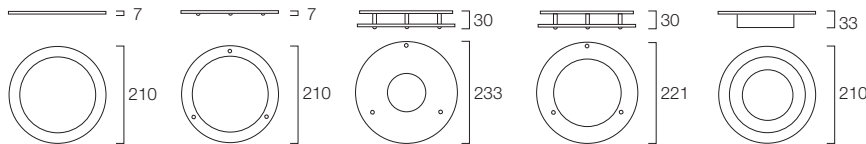

Bezel Only
IP44 Glass Cover
Kick Deflector

IP54 Vandal
Resistant Cover

Profile Glass

Glass Ring
Glass Disc

Drop Glass
Cylinder



Frosted Drop Glass Cylinder Blue Ring

160mmØ Accessories Order separately

	White Bezel	Silver Bezel	
Bezel Only	2028614	2028038	0.11kg
Clear Glass IP44 Cover	2028034	2028600	0.20kg
Etched Glass IP44 Cover	2028036	2028602	0.20kg
Polycarbonate IP54 Cover	2039013		0.18kg
Floating Frosted Glass Ring	2038980		0.50kg
Floating Glass Ring Blue Gel	2038984		0.50kg
Floating Profile Cut Glass	2039021		0.56kg
Floating Glass Disc Fully Etched	2028060	2028608	0.45kg
Floating Frosted Cylinder Blue Ring	2034493	2034494	0.16kg
Floating Frosted Cylinder Clear Ring	2028549	2028612	0.16kg
Decorative Cone Down Opal*		2034183	0.09kg
Decorative Cone Down Blue*		2034184	0.09kg
Cross Vane Louvre*		2034188	0.07kg

* Twin lamp luminaires only (Except Wallwashers)



Decorative Cone Down Blue



Cross Vane Louvre

LED 150-TE II

185mmØ Bezel

- 2 x 18w TC-TEL will also accept 2 x 18w TC-DEL lamps



Axial Faceted Reflector

185mmØ	HF	1-10v Dimmable		Emergency	Emergency Dimmable	
1 x 32w TC-TEL	2038676	2038716	1.26kg	2038677	2038717	4.86kg
2 x 18w TC-TEL/DEL	2038678	2038718	1.26kg	2038680	2038720	4.86kg
2 x 26w TC-TEL	2038681	2038721	1.26kg	2038682	2038722	4.86kg

Diamond Faceted Reflector

185mmØ						
1 x 32w TC-TEL	2038696	2038736	1.26kg	2038697	2038737	4.86kg
2 x 18w TC-TEL/DEL	2038698	2038738	1.26kg	2038700	2038740	4.86kg
2 x 26w TC-TEL	2038701	2038741	1.26kg	2038702	2038742	4.86kg

Emergency Gear Dimensions

175 x 130 x 70



Frosted Drop Glass Cylinder Clear Ring Accessory

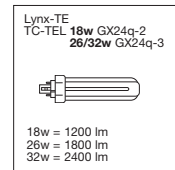
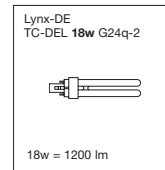
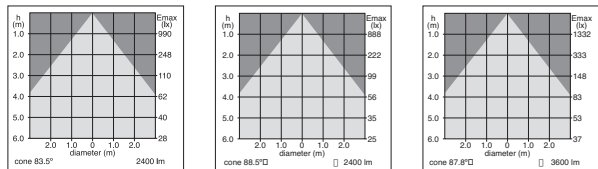
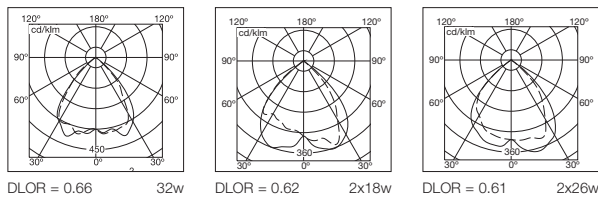
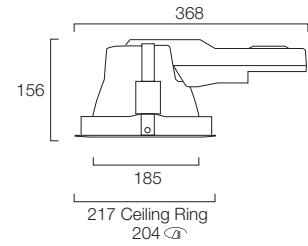

LED 150-TE II

185mmØ Wallwasher

- Specular smooth reflector
- Even ceiling to wall illumination
- Ideal for reducing 'cavern effect'

Specular Reflector

185mmØ	HF	
2 x 18w TC-TEL	2038751	1.22kg

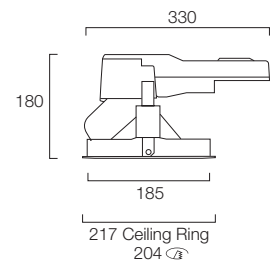
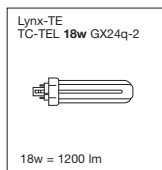
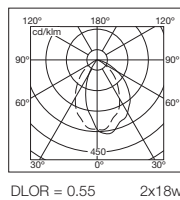

LED 150-TE II

185mmØ Accessories



Silver Bezel



White Bezel + IP54 Vandal Resistant Cover



White Bezel + IP44 Glass Cover



Floating Profile Cut Glass Disc



Floating Frosted Glass Ring



Floating Glass Ring Blue Gel



Frosted Drop Glass Cylinder Blue Ring



Comfort Diffuser



Decorative Cone Down Blue



Cross Vane Louvre

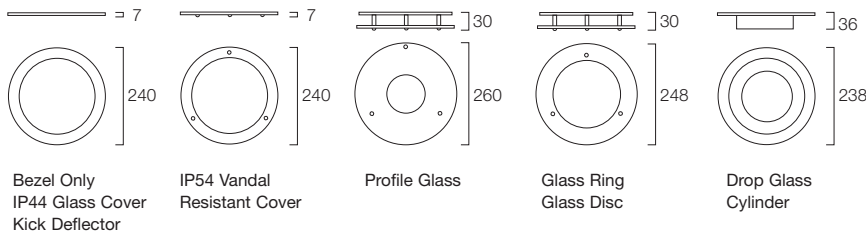

185mmØ Accessories Order separately

	White Bezel	Silver Bezel	
Bezel Only	2038996	2038997	0.13kg
Clear Glass IP44 Cover	2038990	2038991	0.20kg
Polycarbonate IP54 Cover	2039014		0.18kg
Floating Frosted Glass Ring	2038981		0.93kg
Floating Glass Ring Blue Gel	2038985		0.95kg
Floating Profile Cut Glass	2039022		1.28kg
Floating Glass Disc Fully Etched	2039001		0.72kg
Floating Frosted Cylinder Blue Ring	2039003	2039004	0.30kg
Floating Frosted Cylinder Clear Ring	2039005	2039006	0.30kg
Comfort Diffuser	2039024		0.22kg
Decorative Cone Down Opal*		2034183	0.09kg
Decorative Cone Down Blue*		2034184	0.09kg
Cross Vane Louvre*		2034190	0.07kg

* Twin lamp luminaires only (Except Wallwashers)

LED 150-TE II

215mmØ Bezel

- 2 x 32w TC-TEL versions will also accept 2 x 26w TC-DEL lamps



Axial Reflector with Silver Bezel Accessory

Axial Faceted Reflector

215mmØ	HF	1-10v Dimmable	Emergency	Emergency Dimmable	
1 x 42w TC-TEL	2038687	2038727	1.29kg	2038688	2038728 4.89kg
2 x 32w TC-TEL/DEL	2038683	2038723	1.29kg	2038684	2038724 4.89kg
2 x 42w TC-TEL	2038685	2038725	1.29kg	2038686	2038726 4.89kg
1 x 57w TC-TELI	2041717	2041719	1.29kg	2041718	2041720 4.89kg

Diamond Faceted Reflector

215mmØ	HF	1-10v Dimmable	Emergency	Emergency Dimmable	
1 x 42w TC-TEL	2038707	2038747	1.29kg	2038708	2038748 4.89kg
2 x 32w TC-TEL/DEL	2038703	2038743	1.29kg	2038704	2038744 4.89kg
2 x 42w TC-TEL	2038705	2038745	1.29kg	2038706	2038746 4.89kg
1 x 57w TC-TELI	2041721	2041723	1.29kg	2041722	2041724 4.89kg

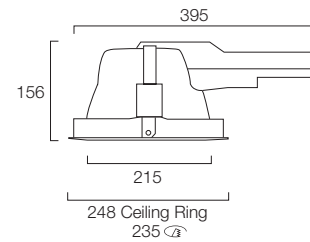

Emergency Gear Dimensions

175 x 130 x 70

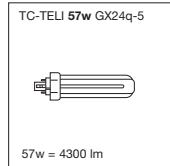
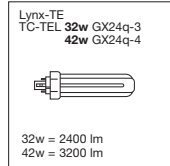
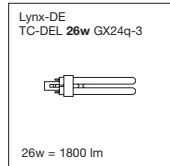
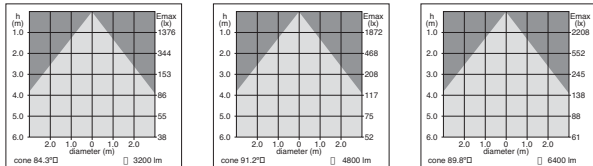
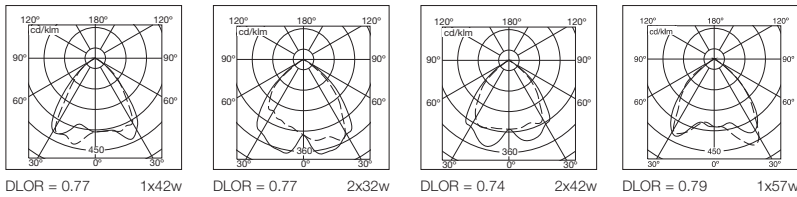

LED 150-TE II

215mmØ Wallwasher

- Specular smooth reflector
- Even ceiling to wall illumination
- Ideal for reducing 'cavern effect'



Specular Reflector

215mmØ	HF	
2 x 26/32w TC-TEL	2038752	1.23kg

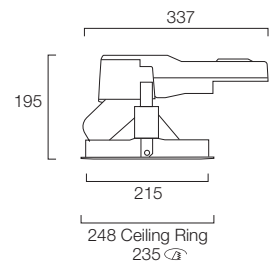
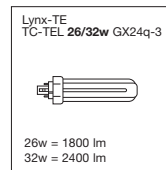
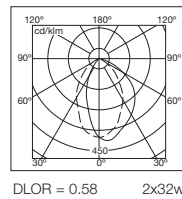

LED 150-TE II

215mmØ- Accessories



Silver Bezel



White Bezel + IP54 Vandal Resistant Cover



White Bezel + IP44 Glass Cover



Floating Profile Cut Glass Disc



Floating Frosted Glass Ring



Floating Glass Ring Blue Gel



Frosted Drop Glass Cylinder Blue Ring

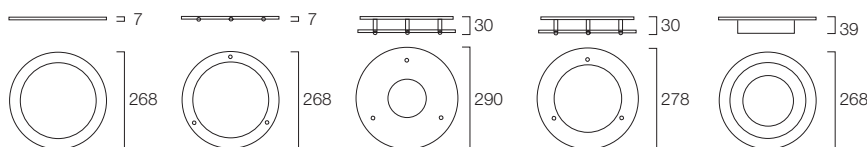

Bezel Only
IP44 Glass Cover
Kick Deflector

IP54 Vandal
Resistant Cover

Profile Glass

Glass Ring
Glass Disc

Drop Glass
Cylinder



Comfort Diffuser



Decorative Cone Down Blue



Cross Vane Louvre

215mmØ Accessories Order separately

	White Bezel	Silver Bezel	
Bezel Only	2038998	2039000	0.15kg
Clear Glass IP44 Cover	2038992	2038993	0.30kg
Polycarbonate IP54 Cover	2039015		0.25kg
Floating Frosted Glass Ring	2038982		1.02kg
Floating Glass Ring Blue Gel	2038986		1.04kg
Floating Profile Cut Glass	2039023		1.46kg
Floating Glass Disc Fully Etched	2039002		0.85kg
Floating Frosted Cylinder Blue Ring	2039007	2039008	0.37kg
Comfort Diffuser	2039025		0.36kg
Decorative Cone Down Opal*		2034183	0.09kg
Decorative Cone Down Blue*		2034184	0.09kg
Cross Vane Louvre*		2034191	0.11kg

* Twin lamp luminaires only (Except Wallwashers)



Kometa 300



- Kometa looks and performs like no other lighting fixture by combining ambient lighting with downlighting in a simple stylish luminaire
- It provides the complete lighting solution, without the need to supplement the installation with uplighters and wallwashers, by providing a ceiling illuminance which is 30% of working plane levels and a wall illuminance equivalent to 50%

Kometa 300 Modular

Control Gear:	Standard: Integral electronic x 2 Dimmable: Digital Dimmable x 2 PCA Eco Switch Dim and DSI compatible
Emergency:	Integral, 3hr maintained (T5)
Reflector:	Aluminium-vacuum metalised
Ambient Diffuser:	Polycarbonate, opal
Mounting:	4 x stainless steel mounting clips

Kometa RGB DMX LED

Kometa RGB DMX LED array consists of 90 LED's, 30 red, 30 green and 30 blue. Each LED is driven with approximate forward current of 20mA
Red LED dominant wavelength 626nm
Green LED dominant wavelength 525nm
Blue LED dominant wavelength 470nm

Kometa 300

Circular

- Compact dual purpose downlight
- Complements Kometa luminaire
- Just 300mm in diameter
- Independently switched options
- Dimmable and emergency versions as standard
- 22w circular T5 and 26w TC-TEL lamp package
- Provides all surface illumination ideal for corridors, circulation areas and secondary office spaces



Standard

	Single Switched	Twin Switched
1 x 26w TC-TEL / 22w T16-R	2037420	2037422

Emergency

1 x 26w TC-TEL / 22w T16-R	2037421	2037423
----------------------------	----------------	----------------

Dimmable

1 x 26w / 22w DSI Dim	2038310
-----------------------	----------------

Dimmable Emergency

1 x 26w / 22w DSI Dim Emg	2038311
---------------------------	----------------

NEW RGB DMX

RGB LED +1 x 26wTC-TL	2041245
-----------------------	----------------

Kometa RGB DMX version requires a professional DMX control desk or suitable lighting control software with USB interface for complete synchronisation of scenes and colour changing sequences.

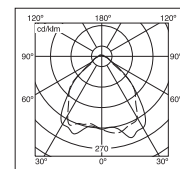
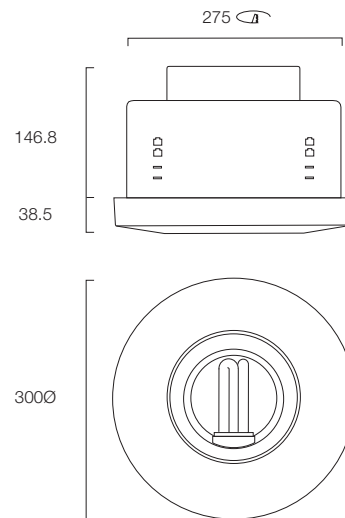

DLOR=0.53 ULOR=0.04
2037420



Kometa 600
see page 13

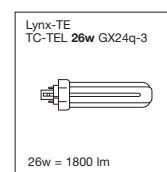

Lynx-TE
TC-TEL 26w GX24q-3

26w = 1800 lm

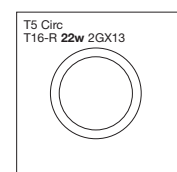

T5 Circ
T16-R 22w 2GX13



Concord:marlin Downlights

In areas with higher ceilings, there is increased likelihood that glare from downlighters will create visual discomfort in the space. It is therefore important that in glare sensitive areas downlights have reflectors with steep cut off angles.

In theory, lighting spaces with high ceilings is not a difficult task, however the reality can be more complex. Walls need to be evenly and proportionately lit and general illumination and light distribution with the necessary spacing needs to be established. Accent of objects such as planters, statues, information booths or reception desks needs to be crisp and stand out from the general illumination; the standard 40° cut-off across the Performance Cone range provides a beam ideal for this type of accent lighting.

Choosing the right light source is also crucial when considering access and maintenance, long service life of HID lamps and the flexibility of lamp access from the rear (Equinox) or the front (Performance Cones) play an important part in making the right scheme design choices.

Equinox & Performance Cone double focus downlights, for both tungsten halogen and HID lamps, allow small ceiling apertures without loss of performance. Double focus downlights are ideal for decorative or acoustic ceilings.

Darklight reflectors have pre-determined cut-off angles, which, within the reflector, ensure it appears dark. When using darklight reflectors the visual appearance in the ceiling is the same regardless of which lamps or beam angles are used, resulting in no direct or reflected glare. Darklight reflectors only appear illuminated when encroaching within the cut off angle.

Directional downlights combine all the characteristics and benefits of fixed Equinox and Performance Cone downlights with the added advantage of being able to rotate and tilt, offering even more flexibility to a scheme or simply allowing a direct downlight from a sloped ceiling.

Wall-washers are designed to give an even transition to the wash between the ceiling and floor and appear visually undifferentiated from the downlights.

Certain models of Equinox and Performance Cones have accessory bezels allowing a range of decorative visual affects to be created. These accessories allow a mix and match with Concord:marlin LED CFL downlights. In addition the Performance Cone accessory downlight, fixed & adjustable models accept a range of lighting tools from our Torus range of spotlights including elongation lens 5:1, filters and honeycomb louvre.

From the Concord:marlin downlighter range we suggest that Equinox is ideal for a rooms with ceilings over 6 metres high and Performance Cones are ideal for ceilings up to 6m. When combined with our standard downlights like LED and Myriad, many sharing trim dimensions and accessories, these products provide an ideal solution to these demanding challenges.

Key to symbols:

Can be used for
single or double
height ceilings

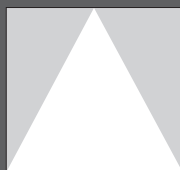

Wide beam
Single or double
height ceiling



Narrow beam
Single or double
height ceiling



Adjustable beam
Single or double
height ceiling



Wallwasher
Single or double
height ceiling



Double wallwasher
Single or double
height ceiling



Single wallwasher
Single or double
height ceiling

Can be used for
double height
ceilings

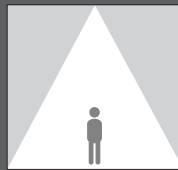

Wide beam
Double height ceiling



Narrow beam
Double height ceiling



Adjustable beam
Double height ceiling



Wallwasher
Double height ceiling

Can be used for
single height ceilings



Wide beam
Single height ceiling



Narrow beam
Single height ceiling



Adjustable beam
Single height ceiling

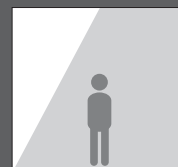

Wallwasher
Single height ceiling



Equinox

Lamp Replacement



1 Use arrows to 'pop' reflector free and lower with lampholder from ceiling ring



2 Remove lampholder from reflector after unclipping the retaining clip



3 Loose reflector is suspended by security chain



4 Hold new lamp with sleeve to replace. Re-clip the lampholder onto the reflector



5 After re-lamping, reflector 'snap' fits back into place

Applications

- High Ceiling Applications
- Shopping Centres
- Atria
- Showrooms
- Leisure Centres
- Under Canopy Lighting
- Theatres
- Cinemas, Casinos & Hotels

- Extensive range of high performance downlights
- Slimline ceiling trim just 11mm
- Narrow and wide beam options
- CMI/CDM-T and mains TH lamp options
- Easy fit reflector mechanism
- Smooth textured reflector
- Wallwasher and gimbal versions
- LORs of up to 77%
- High frequency electronic control gear
- Suitable for ceilings 1-30mm in thickness
- Optional remote 20w 12v emergency pack
- All luminaires can be installed from below the ceiling (except Dual Cone)
- Vertical lamp luminaires can be re-lamped from above or below the ceiling
- Intumescent fire hoods available

Control Gear:	High frequency electronic
Emergency:	Remote, 3hr sustained, 20w LV capsule
Reflector:	Spun aluminium, textured
Connection:	Mains Halogen: Plug and socket
Plaster Ring:	Lightweight alloy, finished to white RAL 9016
Accessories:	Bezels: Die-cast aluminium Glass: UV Filter: UVILEX [®] glass

Emergency Pack

Separate emergency pack complete with batteries, auxiliary lampholder (inc 12v 20w low pressure capsule lamp) to fit into reflector and an LED to indicate the condition of both battery and lamp filament.

Dimensions: 350 x 135 x 115mm
900mm lead length 6.5kg

Equinox IV

CMI/CDM-T

- Choice of narrow and wide beam options – 19° to 60°
- 35/70/150w CMI/CDM-T lamp options
- High LORs of up to 71%
- Re-lampable from above or below the ceiling
- Integral borosilicate safety glass giving IP44 protection
- Wallwasher versions offer a fixed 30° throw through a combination of tilt and refracting lens
- Gimbal versions adjust through 355° rotation and 30° tilt
- Gimbal versions offer optional UV filter glass to replace standard glass
- Wallwashers and Gimbals are ideal for display or accent lighting
- Choice of housing only or complete with high frequency control gear



Wide Beam



Wallwasher



Gimbal

CDM-T
CMI-T/HIT-CE 35/70/150w
G12

35w = 3300 lm
70w = 6200 lm
150w = 13500 lm

UV Stop lamps only

HSI-T
HIT-UVr 35/70/150w G12

35w = 2400 lm
70w = 5200 lm
150w = 12000 lm

UV Stop lamps only

35/70w Gear

HF Gear
149 x 80 x 34

150w Gear

HF Gear
210 x 80 x 34

Narrow

Beam	Complete with Gear	Complete Weight	Housing Only	Housing Only Weight	Accessory Diameter
35w HIT-UVr/HIT-CE	17° 2038630	1.04kg	2038654	0.64kg	120mm
70w HIT-UVr/HIT-CE	17° 2038634	1.04kg	2038654	0.64kg	120mm
150w HIT-UVr/HIT-CE	23° 2038638	1.44kg	2038658	0.88kg	160mm

Emergency Pack

350 x 135 x 115	Lead length 900mm	2031573	6.50kg
-----------------	-------------------	----------------	--------

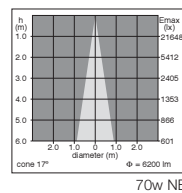
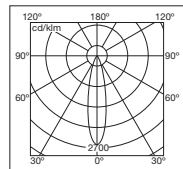
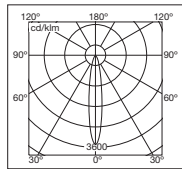

Narrow Beam 35/70w

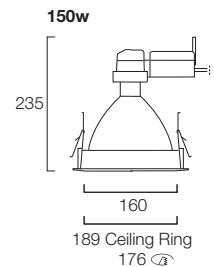
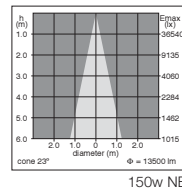
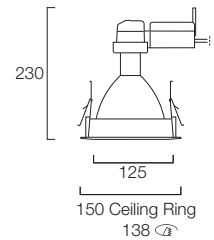

Wide

Beam	Complete with Gear	Complete Weight	Housing Only	Housing Only Weight	Accessory Diameter
35w HIT-UVr/HIT-CE	59° 2038631	1.04kg	2038655	0.64kg	120mm
70w HIT-UVr/HIT-CE	54° 2038635	1.04kg	2038655	0.64kg	120mm
150w HIT-UVr/HIT-CE	53° 2038640	1.44kg	2038660	0.88kg	160mm

Emergency Pack

350 x 135 x 115	Lead length 900mm	2031573	6.50kg
-----------------	-------------------	----------------	--------

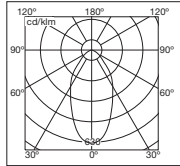

DLOR = 0.71 70w WB

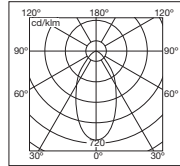

DLOR = 0.71 150w WB

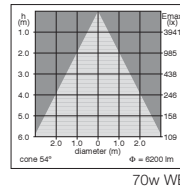

70w WB

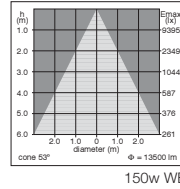

150w WB

Wide Beam 35/70w

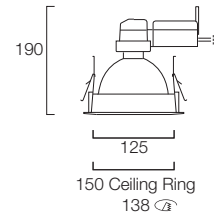

150w

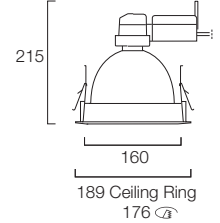

Wallwasher

Beam	Complete with Gear	Complete Weight	Housing Only	Housing Only Weight	Accessory Diameter
35w HIT-UVr/HIT-CE	2038632	1.04kg	2038656	0.64kg	120mm
70w HIT-UVr/HIT-CE	2038636	1.04kg	2038656	0.64kg	120mm
150w HIT-UVr/HIT-CE	2038641	2.03kg	2038661	1.47kg	160mm

Emergency Pack

350 x 135 x 115	Lead length 900mm	2031573	6.50kg
-----------------	-------------------	----------------	--------

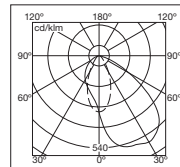
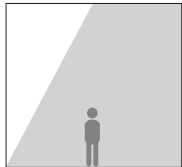

DLOR = 0.62 70w W/W

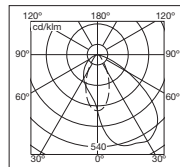

DLOR = 0.62 150w W/W

Wallwashers 35/70w

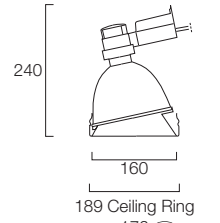

150w

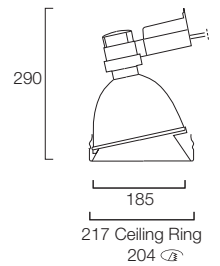

Gimbal

Beam	Complete with Gear	Complete Weight	Housing Only	Housing Only Weight	Accessory Diameter
35w HIT-UVr/HIT-CE	20° 2038633	2.30kg	2038657	1.90kg	—
70w HIT-UVr/HIT-CE	20° 2038637	2.30kg	2038657	1.90kg	—
150w HIT-UVr/HIT-CE	22° 2038642	2.58kg	2038662	2.02kg	—

Gimbal Accessory Order separately For use with Gimbals only

35/70w HIT-UVr/HIT-CE	UV Filter Glass	2025908
150w HIT-UVr/HIT-CE	UV Filter Glass	2025909

Emergency Pack

350 x 135 x 115	Lead length 900mm	2031573	6.50kg
-----------------	-------------------	----------------	--------

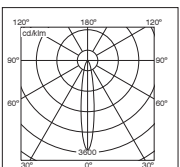
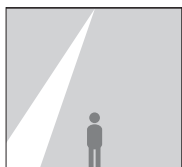

DLOR = 0.61 70w Gimbal

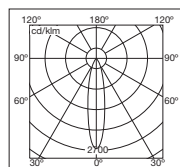

DLOR = 0.67 150w Gimbal



Gimbals 35/70w

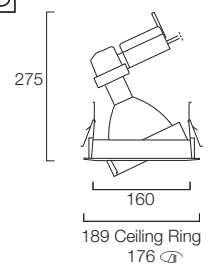

150w

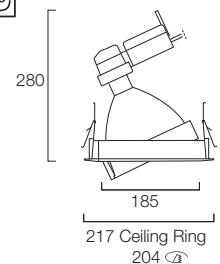

Equinox IV

CMI/CDM-T Dual Cone

- Narrow beam low glare housing ideal for accent lighting in high ceilings
- High peak beam intensity
- Luminaire must be installed from above the ceiling
- 'Cat flap' safety glass hinge allows re-lamping from below the ceiling
- Not suitable for accessories
- Choice of housing only or complete with high frequency control gear
- Suitable for acoustic or decorative ceilings



Dual Cone	Beam	Complete with Gear	Complete Weight	Housing Only	Housing Only Weight
70w HIT-UVr/HIT-CE	17°	2031517	1.20kg	-	0.80kg
70w HIT-UVr/HIT-CE	32°	2031518	1.20kg	2031557	0.80kg
150w HIT-UVr/HIT-CE	15°	2031527	1.36kg	-	0.80kg
150w HIT-UVr/HIT-CE	31°	2031528	1.36kg	2031557	0.80kg

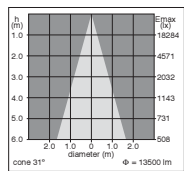
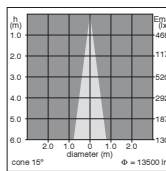
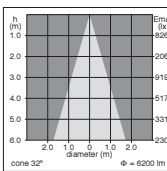
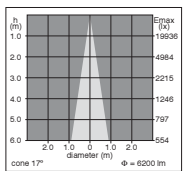
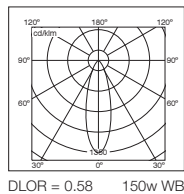
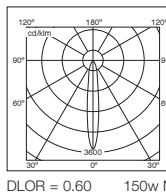
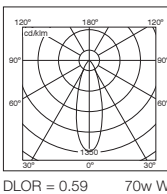
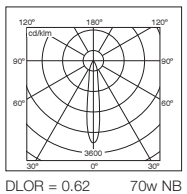
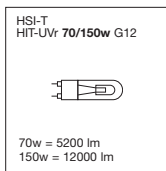
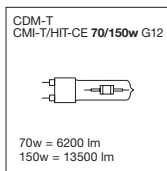

Dual Cone

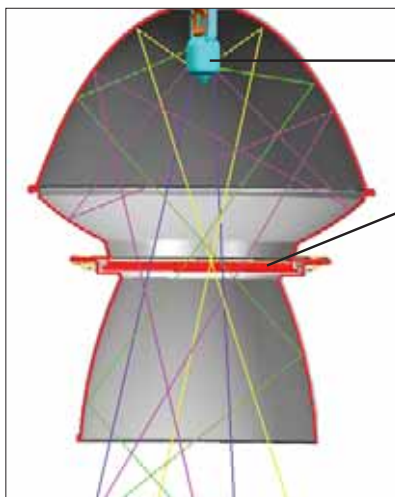
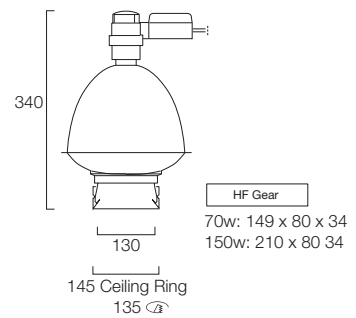

Primary focal point

Secondary focal point

Dual Cones allow for small apertures and high light output by recouping light nominally lost as heat and interreflections. Small aperture is ideal for decorative and acoustic ceilings, including theatres, concert halls, hotels and ballrooms.

Key

- Light reflected once from upper reflector
- Light reflected from upper and lower reflector
- Light gathered and redirected through multiple internal reflections
- Direct light

Equinox IV

Mains Halogen Dual Cone

- Narrow beam low glare housing ideal for accent lighting in high ceilings
- High peak beam intensity
- Luminaire must be installed from above the ceiling
- 'Cat flap' safety glass hinge allows re-lamping from below the ceiling
- Not suitable for accessories



Dual Cone	Beam	Standard Bezel	
250w QT32	17°	2032130	0.90kg
250w QT32	33°	2032131	0.90kg

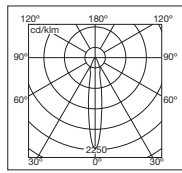

DLOR = 0.48 Narrow

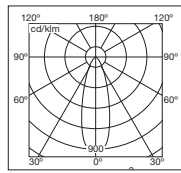

DLOR = 0.45 Wide

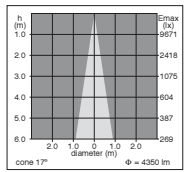
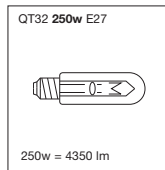

Narrow

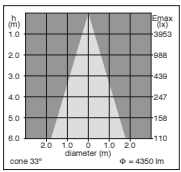

Wide

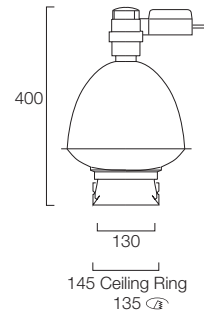
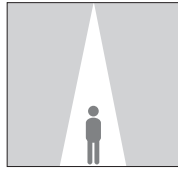

Equinox IV

Mains Halogen

- Wallwashers offer a fixed 30° throw through a combination of tilt and refracting lens
- Gimbals adjust through 355° rotation and 30° tilt
- Re-lampable from above or below the ceiling
- Mains dimmable



Mains Halogen Narrow

QT32 75/100/150w E27

75w = 1100 lm
 100w = 1500 lm
 150w = 2500 lm
 250w = 4350 lm

Open Cone Narrow

	Beam	Code	Accessory Diameter	
75/100/150w QT32	31°	2038646	160mm	0.98kg
250w QT32	25°	2038651	185mm	1.15kg

Emergency Pack

350 x 135 x 115	Lead length 900mm	2031573	6.50kg
-----------------	-------------------	----------------	--------

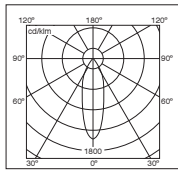
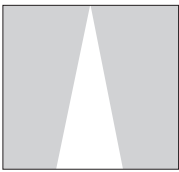

100w NB

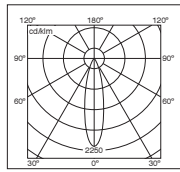

250w NB

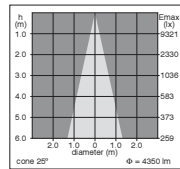
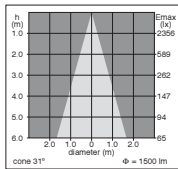

Narrow 75-150w

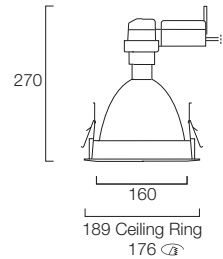

Narrow 250w

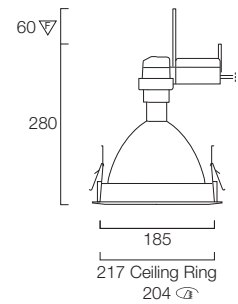



Open Cone Wide

	Beam	Code	Accessory Diameter	
75/100/150w QT32	89°	2038647	160mm	0.98kg
250w QT32	70°	2038652	185mm	1.15kg

Emergency Pack

350 x 135 x 115	Lead length 900mm	2031573	6.50kg
-----------------	-------------------	----------------	--------

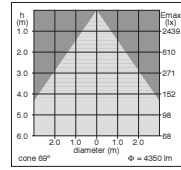
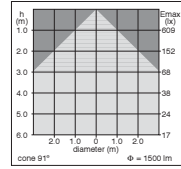
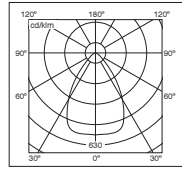
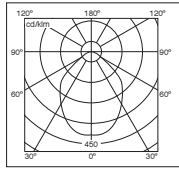
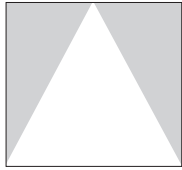

Wide 75-150w

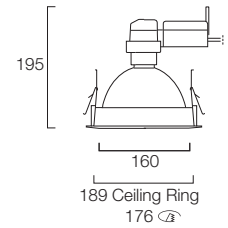

Wide 250w

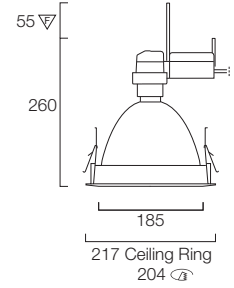

Wallwasher

	Code	Accessory Diameter	
75/100/150w QT32	2038648	185mm	1.44kg

Emergency Pack

350 x 135 x 115	Lead length 900mm	2031573	6.50kg
-----------------	-------------------	----------------	--------

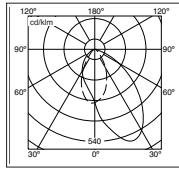
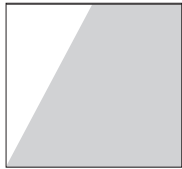

Wallwasher

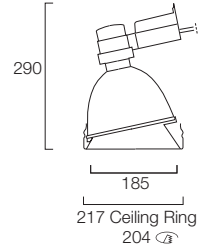

Gimbal

	Beam	Code	Accessory Diameter	
75/100/150w QT32	31°	2038650	-	1.87kg

Gimbal Accessory Order separately For use with 150w Gimbal only

150w HIT-UVr/HIT-CE	UV Filter Glass	2025909
---------------------	-----------------	----------------

Emergency Pack

350 x 135 x 115	Lead length 900mm	2031573	6.50kg
-----------------	-------------------	----------------	--------

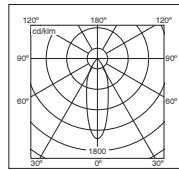
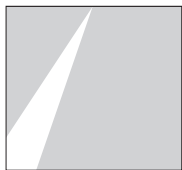

Gimbal

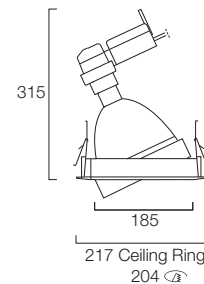

Equinox IV

CMI/CDM-TD

- Wide beam ideal for higher ceiling applications
- Integral borosilicate safety glass giving IP44 protection
- Re-lampable from below the ceiling
- 70/150/250w HIT-DE/HIT-DE-CE lamp options
- 70/150w supplied complete with electronic gear
- Housing only options



CMI/CDM-TD



Double Ended	Beam	Complete with Gear	Complete Weight	Housing Only	Housing Only Weight	Accessory Diameter
70w HIT-DE/HIT-DE-CE	89°	2038643	1.80kg	2038663	1.40kg	160mm
150w HIT-DE/HIT-DE-CE	89°	2038644	1.96kg	2038664	1.40kg	160mm
250w HIT-DE	63 x 103°	2038645	6.89kg	2038665	1.69kg	185mm

Emergency Pack

350 x 135 x 115	Lead length 900mm	2031573	6.50kg
-----------------	-------------------	----------------	--------

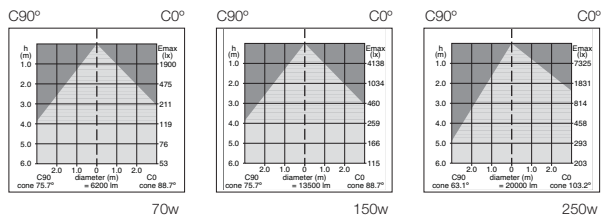
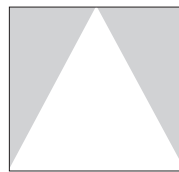
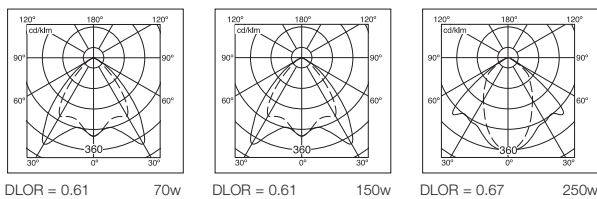

70/150w

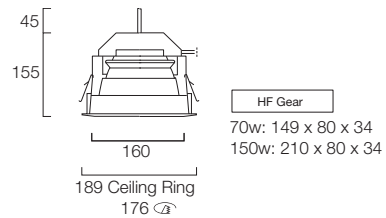

250w

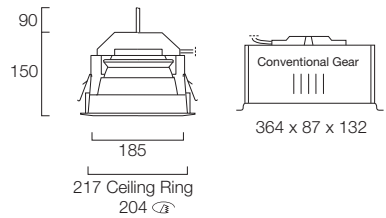

<p>CDM-TD CMI-TD HIT-DE-CE 70w Rx7s 150w Rx7s-24</p> <p>70w = 6200 lm 150w = 13500 lm</p>	<p>HSI-TD HIT-DE 70w Rx7s 150w Rx7s-24 250w Fc2</p> <p>70w = 5500 lm 150w = 13000 lm 250w = 20000 lm</p>
---	--

Equinox IV

Accessories

120mmØ Accessory

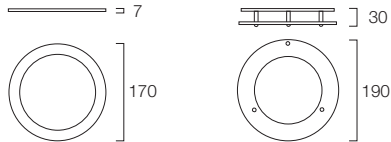

160mmØ Accessory

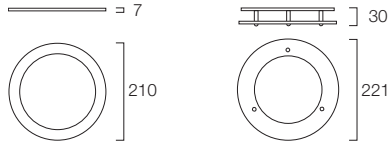

185mmØ Accessory

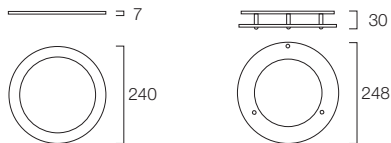

Silver Bezel



IP44 Glass Cover with White Bezel



UV Filter IP44 Glass Cover



Clear Glass Ring with Blue Gel

120mm Ø Accessories	Order separately	White	Silver	
Bezel Only		2028613	2028037	0.09kg
Clear Glass IP44 Cover		2028033	2028599	0.15kg
Floating Glass Ring Blue Gel		2038983	-	0.40kg
UV Filter IP44 Glass Cover*		2039026	-	0.15kg

160mm Ø Accessories	Order separately	White	Silver	
Bezel Only		2028614	2028038	0.11kg
Clear Glass IP44 Cover		2028034	2028600	0.20kg
Floating Frosted Glass Ring		2038980	-	0.50kg
Floating Glass Ring Blue Gel		2038984	-	0.50kg
UV Filter IP44 Glass Cover*		2039027	-	0.20kg

185mm Ø Accessories	Order separately	White	Silver	
Bezel Only		2038996	2038997	0.13kg
Clear Glass IP44 Cover		2038990	2038991	0.30kg
Floating Frosted Glass Ring		2038981	-	0.93kg
Floating Glass Ring Blue Gel		2038985	-	0.95kg
UV Filter IP44 Glass Cover*		2039028	-	0.30kg

* Uses UVILEX® glass

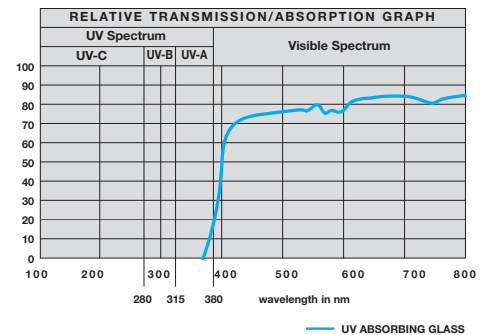

UVILEX® is a trademark of Deutsche Spezial Glass AG Grunplan

Concord:marlin Downlights

In areas with higher ceilings, there is increased likelihood that glare from downlighters will create visual discomfort in the space. It is therefore important that in glare sensitive areas downlights have reflectors with steep cut off angles.

In theory, lighting spaces with high ceilings is not a difficult task, however the reality can be more complex. Walls need to be evenly and proportionately lit and general illumination and light distribution with the necessary spacing needs to be established. Accent of objects such as planters, statues, information booths or reception desks needs to be crisp and stand out from the general illumination; the standard 40° cut-off across the Performance Cone range provides a beam ideal for this type of accent lighting.

Choosing the right light source is also crucial when considering access and maintenance, long service life of HID lamps and the flexibility of lamp access from the rear (Equinox) or the front (Performance Cones) play an important part in making the right scheme design choices.

Equinox & Performance Cone double focus downlights, for both tungsten halogen and HID lamps, allow small ceiling apertures without loss of performance. Double focus downlights are ideal for decorative or acoustic ceilings.

Darklight reflectors have pre-determined cut-off angles, which, within the reflector, ensure it appears dark. When using darklight reflectors the visual appearance in the ceiling is the same regardless of which lamps or beam angles are used, resulting in no direct or reflected glare. Darklight reflectors only appear illuminated when encroaching within the cut off angle.

Directional downlights combine all the characteristics and benefits of fixed Equinox and Performance Cone downlights with the added advantage of being able to rotate and tilt, offering even more flexibility to a scheme or simply allowing a direct downlight from a sloped ceiling.

Wall-washers are designed to give an even transition to the wash between the ceiling and floor and appear visually undifferentiated from the downlights.

Certain models of Equinox and Performance Cones have accessory bezels allowing a range of decorative visual affects to be created. These accessories allow a mix and match with Concord:marlin LED CFL downlights. In addition the Performance Cone accessory downlight, fixed & adjustable models accept a range of lighting tools from our Torus range of spotlights including elongation lens 5:1, filters and honeycomb louvre.

From the Concord:marlin downlighter range we suggest that Equinox is ideal for a rooms with ceilings over 6 metres high and Performance Cones are ideal for ceilings up to 6m. When combined with our standard downlights like LED and Myriad, many sharing trim dimensions and accessories, these products provide an ideal solution to these demanding challenges.

Key to symbols:

Can be used for
single or double
height ceilings



Wide beam
Single or double
height ceiling



Narrow beam
Single or double
height ceiling



Adjustable beam
Single or double
height ceiling



Wallwasher
Single or double
height ceiling



Double wallwasher
Single or double
height ceiling



Single wallwasher
Single or double
height ceiling

Can be used for
double height
ceilings

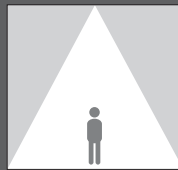

Wide beam
Double height ceiling



Narrow beam
Double height ceiling



Adjustable beam
Double height ceiling



Wallwasher
Double height ceiling

Can be used for
single height ceilings



Wide beam
Single height ceiling



Narrow beam
Single height ceiling



Adjustable beam
Single height ceiling

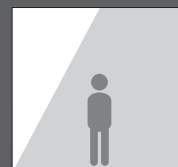

Wallwasher
Single height ceiling



Performance Cones

Performance Cones offer advanced control of the lighting effect, reducing glare to increase visual comfort in any space without sacrificing light output. They can also be used as a high performance accent lighting source. All the products in the range provide an easily controllable high quality light distribution. The accessory versions allow the fitting of the full range of Torus accessories to create a wide range of lighting effects.

A common cut-off angle of 40° is used throughout the range regardless of fitting or lamp specified, this provides a visual consistency within the lighting scheme and an optimum balance between horizontal and vertical illuminance.



Adjustable Double Focus

- Comprehensive range of high performance downlights
- All metal construction
- Low voltage, mains voltage, discharge lamp options
- Low glare luminaires with a shielded cut off angle of 40°
- LOR's up to 66%
- Single and twin wallwasher versions
- Accessory options to accept a wide range of lenses and colour filters
- Tilttable luminaires ideal for sloping ceilings
- Choice of silver or black cones
- CMI/CDM-R and PAR lamp Multigroove options
- Small ceiling aperture, double focus luminaires
- Entire range unified by 175mm ceiling ring
- All low voltage luminaires supplied complete with electronic dimmable transformers
- All CMI/CDM-T luminaires supplied complete with electronic gear

Control Gear:	Tungsten (mains): No gear required LV: Remote electronic transformer HIT: Remote electronic ballast with overload protection
Dimming:	LV suitable for leading and trailing edge dimmers
Connection:	Tungsten (mains): Plug and socket LV/HIT: 3 way terminal block
Reflector:	Super pure specular aluminium, silver or gloss black RAL 9005
Lampholder Housing:	Die cast aluminium, powder coated textured black RAL 9005
Ceiling Ring:	Aluminium, powder coated white RAL 9016
Accessory Lens/Filters:	Glass
Accessory Trim:	Pre-finished adhesive aluminium

Performance Cones

Darklight Reflector

- Low glare 40° cut off
- 100w LV or 35/70w CMI/CDM-T lamp options
- Complementary wallwashers with identical ceiling aperture
- CMI/CDM-T versions offer long lamp life ensuring lower maintenance costs



Silver Cone	Beam	Complete with Gear/Trans	
100w QT12-LPax	47°	2035270	0.72kg
35w HIT-CE	58°	2035296	1.14kg
70w HIT-CE	58°	2035323	1.14kg

Silver Cone		Housing Only	
100w QT12-LPax	47°	2035396	0.52kg
35w HIT-CE	58°	2035370	0.74kg
70w HIT-CE	58°	2035370	0.74kg

Accessories Order separately Bright Chrome

Bezel Trim Accessory **2035030**

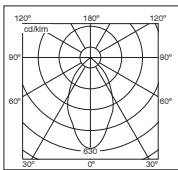

DLOR = 0.58

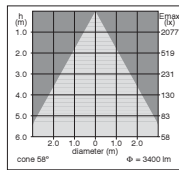

35w

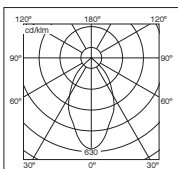

DLOR = 0.58

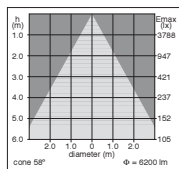

70w

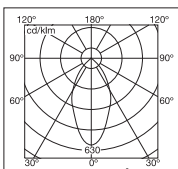

DLOR = 0.66

100w QT12-LPax

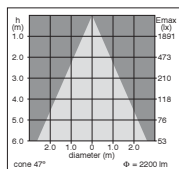

100w

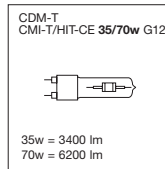
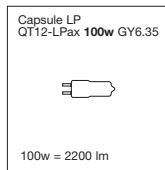

UV Stop lamps only

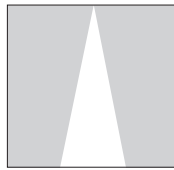

Darklight Reflector

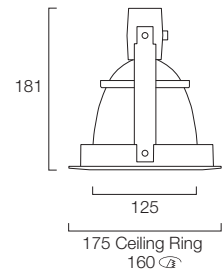

Darklight Reflector

The darklight reflector offers a very controlled beam and a clearly defined 40° cut-off angle with no discernable glare. The secondary glass diffuser produces a soft even beam ideal for ambient lighting large open spaces.

Applications

Areas where high visual comfort is required for example theatres, office or hotel receptions.



40° Darklight

Performance Cones

Single/Double Wallwashers

- Single and double wallwasher options
- 100w LV or 35/70w CDM-T lamp options
- Even wall illumination creating proportion and balance within a scheme
- Double wallwashers ideal for corridor or walkway illumination
- Ceiling aperture matches that of the standard Darklight luminaire



Wallwasher Single	Complete with gear/transformer	
100w QT12-LPax	2035272	0.82kg
35w HIT-CE	2035298	1.24kg
70w HIT-CE	2035325	1.24kg

Wallwasher Single	Housing Only	
100w QT12-LPax	2035398	0.64kg
35w HIT-CE	2035372	0.84kg
70w HIT-CE	2035372	0.84kg

Wallwasher Double	Complete with gear/transformer	
100w QT12-LPax	2035274	0.82kg
35w HIT-CE	2035301	1.24kg
70w HIT-CE	2035327	1.24kg

Wallwasher Double	Housing Only	
100w QT12-LPax	2035401	0.64kg
35w HIT-CE	2035374	0.84kg
70w HIT-CE	2035374	0.84kg

Accessories	Order separately	Bright Chrome
Bezel Trim Accessory	2035030	



Single/Double Wallwasher

Single/Double Wallwasher

Combines a high quality, low-glare down-lighter with single or double wall-washing function, the wash effect provides excellent evenly distributed illumination of the floor which continues onto the wall with no loss of evenness.

Applications

Ideal for corridors where the floor and the walls can be lit from a single recessed fitting.

Meeting rooms, lecture theatres, hotel and office receptions or corridors where the fitting can be used to illuminate wall displays in addition to providing an ambient light source.

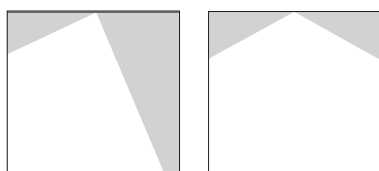
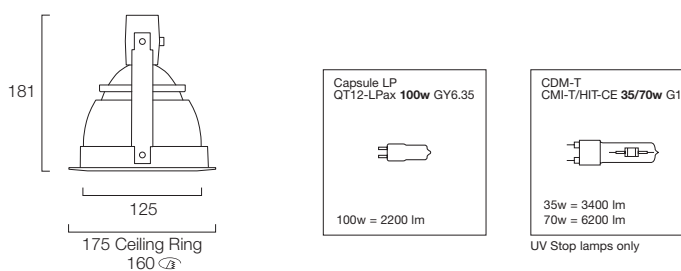

Single Wallwasher

Double Wallwasher



Central Double Wallwasher with 2 x Single Wallwasher

Performance Cones

Double Focus

- Low glare 40° cut off angle
- Reflector aperture of just 85mm
- Adjustable option with 0-35° tilt
- Narrow beam version with 40° beam angle
- Wide beam version with 60° beam angle
- 100w LV or 35/70w CMI/CDM-T lamp options



Double Focus Complete with gear/transformer

	Beam	Silver Cone	
100w QT12-LPax	40°	2035276	0.80kg
100w QT12-LPax	60°	2035277	0.80kg
35w HIT-CE	40°	2035303	1.20kg
35w HIT-CE	60°	2035304	1.20kg
70w HIT-CE	40°	2035330	1.20kg
70w HIT-CE	60°	2035331	1.20kg

Accessories Order separately Bright Chrome

Bezel Trim Accessory	2035030
----------------------	----------------

Double Focus Housing Only	Silver Cone	Black Cone	
100w QT12-LPax	2035403	2035407	0.60kg
100w QT12-LPax	2035404	2035408	0.60kg
35w HIT-CE	2035376	2035381	0.80kg
35w HIT-CE	2035377	2035382	0.80kg
70w HIT-CE	2035376	2035381	0.80kg
70w HIT-CE	2035377	2035382	0.80kg



Double Focus Fixed

Double Focus

The performance cone double focus provides a bright, controllable beam from a very small ceiling aperture, an excellent fitting for areas with high level of architectural detail; this luminaire can create dramatic lighting schemes with no discernable source of light.

Applications

Theatres, concert halls, large office spaces, high end retail environments, hotels, bars and restaurants.

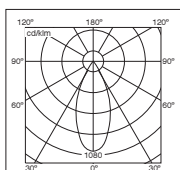
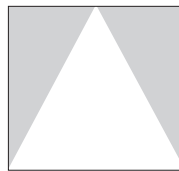
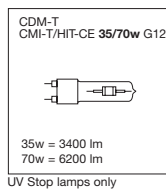
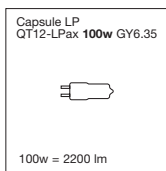
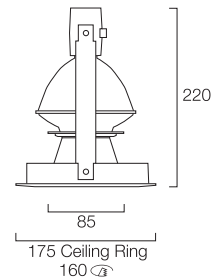

DLOR = 0.55 100w NB

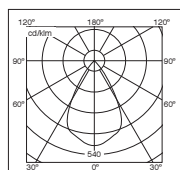

DLOR = 0.45 100w WB

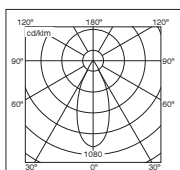

DLOR = 0.51 35w NB

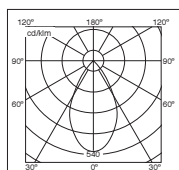

DLOR = 0.43 35w WB

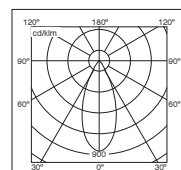

DLOR = 0.46 70w NB

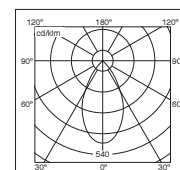

DLOR = 0.38 70w WB

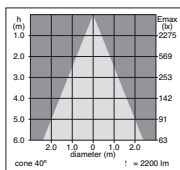

cone 40° 100w NB

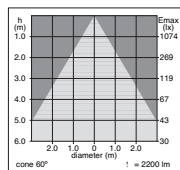

cone 60° 100w WB

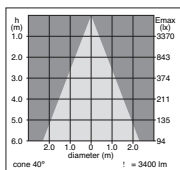

cone 40° 35w NB

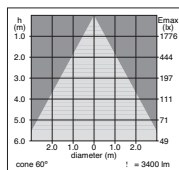

cone 60° 35w WB

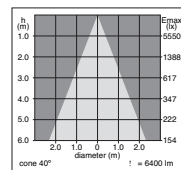

cone 40° 70w NB

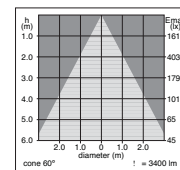

cone 60° 70w WB

Performance Cones

Double Focus Adjustable

- Tilttable double focus luminaire ideal for sloping ceilings
- 0 - 35° tilt



Double Focus Adjustable Complete with gear/transformer

	Beam	Silver Cone		
100w QT12-LPax	40°	2035283	2035287	0.92kg
100w QT12-LPax	60°	2035284	2035288	0.92kg
35w HIT-CE	40°	2035310	2035314	1.32kg
35w HIT-CE	60°	2035311	2035315	1.32kg
70w HIT-CE	40°	2035336	2035341	1.32kg
70w HIT-CE	60°	2035337	2035342	1.32kg

Accessories Order separately

	Bright Chrome
Bezel Trim Accessory	2035030

Double Focus Adjustable Housing only

	Silver Cone	Black Cone	
100w QT12-LPax	2035410	2035414	0.72kg
100w QT12-LPax	2035411	2035415	0.72kg
35w HIT-CE	2035383	2035387	0.92kg
35w HIT-CE	2035384	2035388	0.92kg
70w HIT-CE	2035383	2035387	0.92kg
70w HIT-CE	2035384	2035388	0.92kg



Double Focus Adjustable

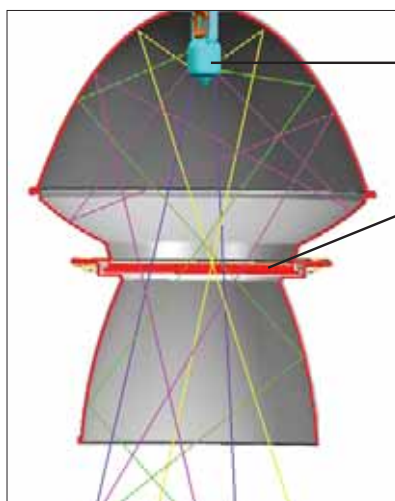
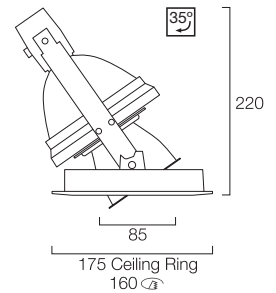
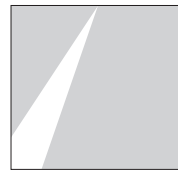

Primary focal point

Secondary focal point

Double focus adjustable Cones can be fitted into sloping ceilings or used to provide adjustable accent lighting when displays or features may change position. They allow for small apertures and high light output by recouping light nominally lost as heat and interreflections. Small aperture is ideal for decorative and acoustic ceilings, including theatres, concert halls, hotels and ballrooms.

Key

- Light reflected once from upper reflector
- Light reflected from upper and lower reflector
- Light gathered and redirected through multiple internal reflections
- Direct light

Performance Cones

Accessory Standard & Adjustable Downlight

- Accepts spot, flood or elongation lens accessory
- Colour filters available
- UV, daylight and flesh tone filters preserve and enhance artifacts and merchandise
- Fixed luminaire has 40° cut off angle
- Accessory downlight must be used with a lens (except QR-LP111)
- Adjustable luminaire with 0-35° tilt



Fixed Accessory Downlight Complete with gear/transformer

	Silver Cone	
35w HIT-CE	2035316	1.23kg
70w HIT-CE	2035343	1.23kg
100w QT12-LPax	2035290	0.83kg
100w QR-LP111	2035350	1.10kg

Fixed Accessory Downlight Housing only

	Silver Cone	Black Cone	
35w HIT-CE	2035390	2035392	0.83kg
70w HIT-CE	2035390	2035392	0.83kg
100w QT12-LPax	2035416	2035418	0.63kg
100w QR-LP111	2035423	2035425	0.74kg

Accessory Downlight Adjustable Complete with gear/transformer

	Silver Cone	
35w HIT-CE	2035320	1.40kg
70w HIT-CE	2035346	1.40kg
100w QT12-LPax	2035293	1.00kg
100w QR-LP111	2035353	0.94kg

Accessory Downlight Adjustable Housing only

	Silver Cone	Black Cone	
35w HIT-CE	2035393	2035395	1.00kg
70w HIT-CE	2035393	2035395	1.00kg
100w QT12-LPax	2035420	2035422	0.80kg
100w QR-LP111	2035426	2035428	0.92kg

Accessory Downlight Adjustable

	Silver Cone	
35w HIT-CE	2035320	1.40kg
70w HIT-CE	2035346	1.40kg
100w QT12-LPax	2035293	1.00kg
100w QR-LP111	2035353	0.94kg

Accessories Order separately

Bezel Trim	Bright Chrome	
Bezel Trim Accessory	2035030	

Safety Lenses Order separately

Spot*	14°	2027238
Flood*	33°	2027234
Elongation*	Elongation beam 5:1	2027239

* Not suitable for use with QR-LP111

Additional Filters

Honeycomb	Not to be used in combination with colour filters	2027240
UV	100% UVB/C and 70% UVA protection	2027241
Daylight Correction	Converts 3000K to 6000K	2027246
Flesh Tone	Enhances the appearance of flesh tone, vegetables and meat	2032127
Red		2027244
Amber		2027245

Up to 2 filters can be fitted into the accessory holder in addition to the Safety Lens (Honeycomb must be at the front of the holder)



Accessory Downlight



Accessory Downlight Adjustable

Accessory Downlight

The accessory downlight offers the visual comfort benefits of a performance cone with the ability to create lighting effects and features with a wide range of filters, accessories and coloured gels. All accessories are common with the Torus range of spotlights for a fully integrated lighting solution and the inclusion of the QR-LP111 lamp allows a range of additional beam angles.

Accessory Downlight Adjustable

Offers additional functionality to the fixed model as it can be directed to provide flexible accent lighting from a fully recessed downlighter. This allows the creation of the dramatic lighting effects commonly created with spotlights but from a fully recessed fitting keeping clean consistent ceiling lines.

Applications

Ideal for museum and gallery areas as the UV filter option will minimise any harmful effects of light on the exhibits.

Retail spaces will benefit from the range of coloured filters and the flesh-tone filter effectively illuminates fresh produce.

This model can be used to create intimate mood lighting ideally suited for restaurants and bars.

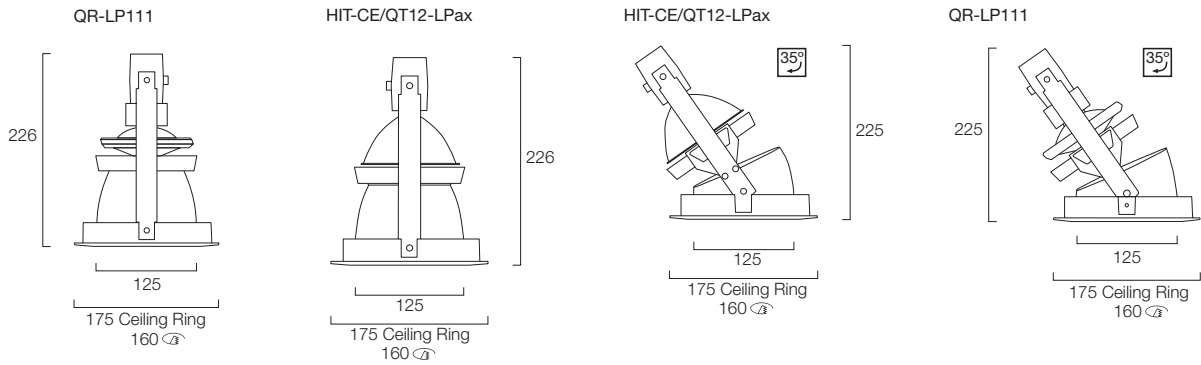
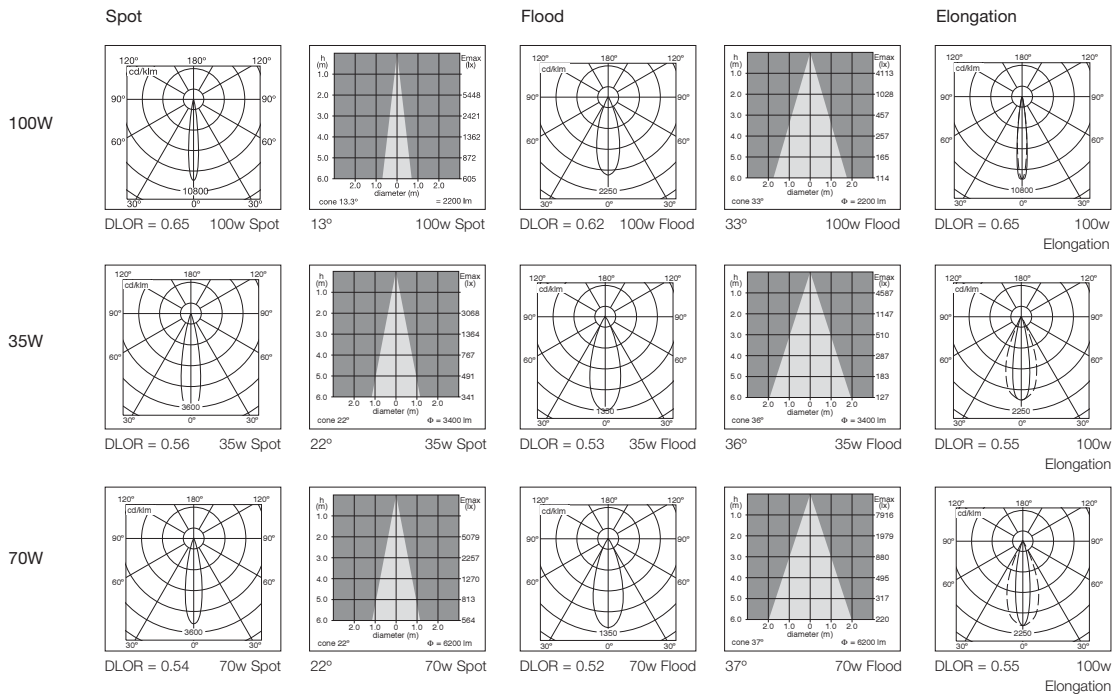

100w QR-LP111 8° Red filter elongation lens Amber filter

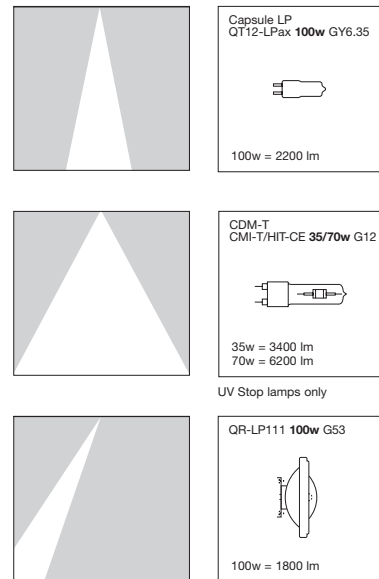

Performance Cones

Deep Multigroove Darklight

- Supplied complete with deep low glare baffle
- PAR lamps ideal for easy dimming
- CDM-R versions offer excellent colour stability



Deep Multigroove Darklight Complete with gear	Black Multigroove	
35w CDM-R PAR	2035357	0.97kg
70w CDM-R PAR	2035358	0.97kg

Deep Multigroove Darklight Housing only	Black Multigroove	
100w QPAR30	2035356	0.87kg
35w CDM-R PAR	2035430	0.97kg
70w CDM-R PAR	2035430	0.97kg
80/120w PAR38	2035360	0.97kg

Accessories Order separately	Bright Chrome	
Bezel Trim Accessory	2035030	

Deep Multigroove Darklight

This is a very low glare fitting which has been designed to accommodate the popular par-lamp options.

Applications

This product is ideally suited for hotels and large domestic residences, theatres and concert halls. Anywhere where dramatic displays of light and shade are needed such as restaurants and bars with seating areas.



PAR30 Deep Multigroove Darklight

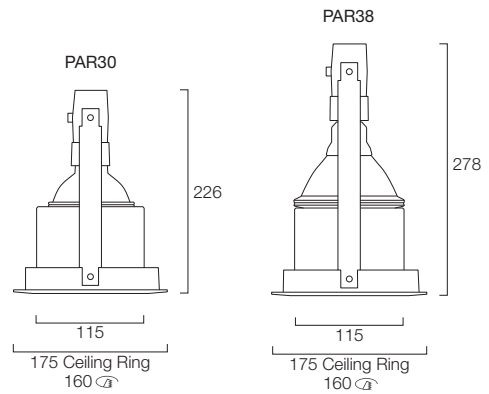

Deep Multigroove Darklight

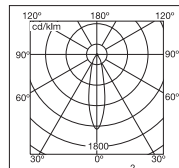

DLOR = 0.40 100w

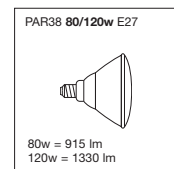
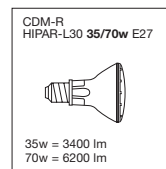
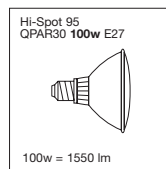
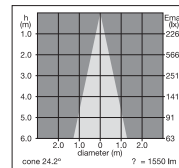

Performance Cones

Directional Darklight

- 0-35° tilt
- Choice of silver or black cones
- PAR lamps ideal for easy dimming
- CDM-R versions offer excellent colour stability



Directional Darklight Complete with gear

	Silver Cone	
35w CDM-R	2035364	0.83kg
70w CDM-R	2035367	0.83kg

Directional Darklight Housing only	Silver Cone	Black Cone	
100w QPAR30	2035361	2035363	0.73kg
35w CDM-R	2035433	2035435	0.73kg
70w CDM-R	2035433	2035435	0.73kg
80/120w PAR38	2035008	2035010	0.83kg

Accessories Order separately	Bright Chrome
Bezel Trim Accessory	2035030



Directional Darklight

Directional Darklight

This luminaire offers a directional dark-light with the convenience of easy lamp changing from its mains lamp options.

Applications

This product is ideally suited for hotels and large domestic residences, theatres and concert halls. Anywhere where dramatic displays of light and shade are needed such as restaurants and bars with seating areas.

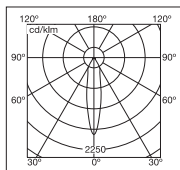
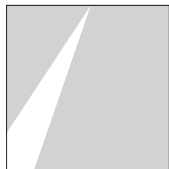

DLOR = 0.65 100w

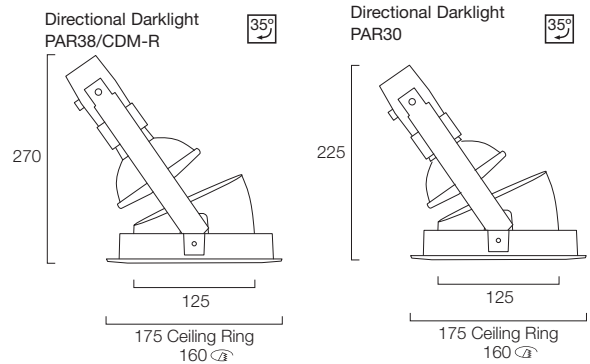
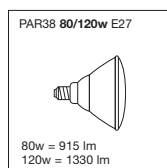
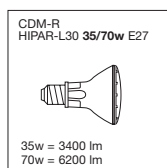
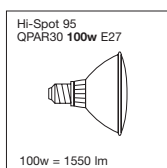
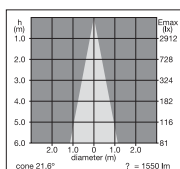



Myriad 4



Applications

- Hotels
- Shops
- Restaurants
- Galleries
- Showrooms
- Reception Areas
- Residential

- Wide choice of lamps and lamp performances with a uniform installed appearance
- Recessed and pendant options share a unified system of decorative control accessories
- Recessed fixtures include optional integral adjustable housings which provide either fully or semi-recessed spotlighting
- Recessed adjustable darklight has an effective non-glare light source
- LV halogen options may be dimmed using either trailing or leading edge dimming systems
- Intumescent fire hoods available

Control Gear/Transformer:	Electronic
Dimming:	Mains dimmable options. Low voltage versions complete with leading and trailing edge dimmable transformers
Emergency:	Remote, 3hr maintained
Reflectors:	Spun aluminium
Housing:	Polyetherimide.
Accessories:	Glass and metal (zinc) construction

Myriad 4

Myriad 50

- Low glare options
- 115mm shallow recess version for restricted ceiling voids
- Choice of shallow 115mm downlights for restricted ceiling voids or low glare 168 deep version



Mains with accessories

Complete Downlight Shallow Housing

Comprises of housing, silver reflector and white bezel + cover glass

	Beam	Silver Reflector With Trans	Less Trans	
50w QT12-LPax	10°	2030600	-	0.27kg
50w QT12-LPax	40°	2030601	2030942	0.27kg

Deep Housing 168mm Order trim separately

Emergency	Beam			
20w HIT-TC-CE	40°	2032132	-	0.44kg
35w HIT-TC-CE	40°	2029622	-	0.44kg
50w QT12-LPax	40°	2029625	2029627	0.23kg
50w QT12-LPax	Remote	40°	2030824	13.00kg
40w QT14	37°	2029623	-	0.14kg
50w QPAR16 (inc)		2529908	-	0.14kg

Shallow Housing 115mm Order trim separately

50w QT12-LPax	10°	2029620	2030938	0.23kg
50w QT12-LPax	40°	2029621	2030940	0.23kg
50w QT12-LPax	Remote	40°	2030823	13.00kg

For technical details of emergency options see page 58

Metal Tile Ceiling Ring

For fixing into metal ceiling tiles. 78-80mm ceiling cut-out **2009836** 0.13kg

Backlight Shield

Reduces rear light spill in open ceilings **2029631** 0.20kg

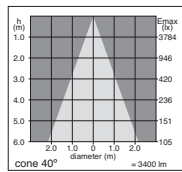

35w HIT-TC-CE

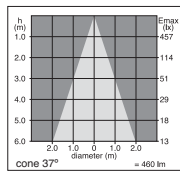

40w QT14

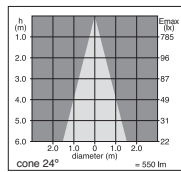

50w QPAR16

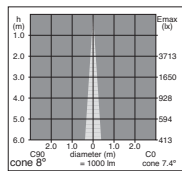

50w QT12-LPax 10°

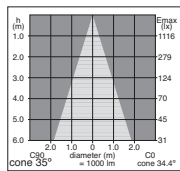

50w QT12-LPax 40°

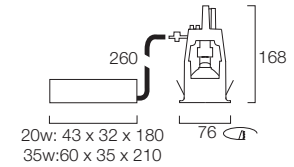
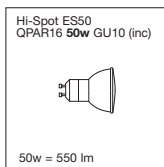
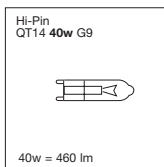
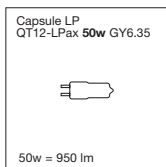
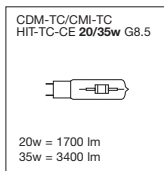

HIT-TC-CE

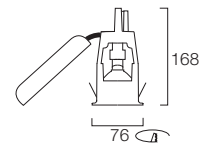

QT12-LPax

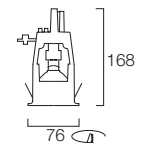

QT14/QPAR16

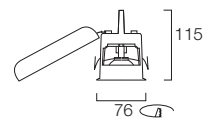

QT12-LPax
Shallow Housing



Ceiling Ring

Myriad 4

Myriad 50



Bezel + Cover Glass



Bezel + Opal Dish



Bezel + Frosted Shallow Ring



Bezel + Metal Ring



Bezel + Kick Deflector



Bezel + Blue Deep Ring



Bezel + Frosted Glow Ring

90mmØ Accessories Order separately

	White	Satin Chrome	Bright Chrome	Gold
Bezel + Cover Glass	2017359	2017358	2017357	2017356
Bezel + Opal Dish	2017375	2017374	2017373	2019080
Bezel + Floating Clear Glass	2017401	2017400	-	-
Bezel + Floating Glass Centre Etched	2008752	-	-	-
Bezel + Metal Ring	2017378	2017377	-	-
Bezel + Kick Deflector	2017398	2017397	-	-
Bezel + Frosted Shallow Ring	2017362	2017361	2017360	-
Bezel + Frosted Deep Ring	2017369	2017367	2017365	2017364
Bezel + Blue Deep Ring	2017370	2017368	2017366	-
Bezel + Frosted Glow Ring	2017382	2017380	-	-
Bezel + Blue Glow Ring	2017383	2017381	-	-

Myriad 4

Myriad 50 Spill Ring & Dichroic

- Order housing and accessory separately



Spill Ring Housing		Beam	Complete With Trans	Less Trans	Complete Weight	
50w QT12-LPax	19°		2030604	-	0.27kg	
Dichroic Housing		Emergency	Complete With Trans	Less Trans	Complete Weight	
50w QR-CBC51			2030620	2030944	0.23kg	
50w QR-CBC51	Remote		2030825	-	13.00kg	
90mmØ Accessories		Order separately	White	Satin Chrome	White Satin	
Bezel + Spill Ring for QT12-LPax			-	-	2017395	0.09kg
Bezel + Black Baffle for QR-CBC51			2017406	2017405	-	0.09kg
Bezel + Chrome Baffle for QR-CBC51			2017407	-	-	0.09kg

For technical details of emergency options see page 88

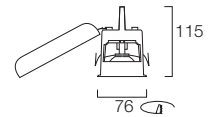
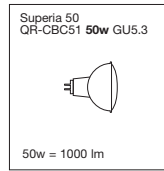
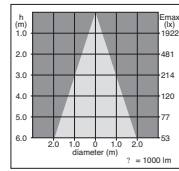
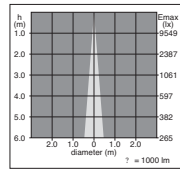
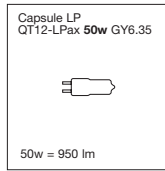
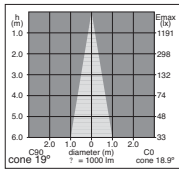

90mmØ White Bezel + Spill Ring Accessory



90mmØ White Bezel + Black Baffle Accessory

Myriad 4

Adjustable Parabolic

- Fully adjustable luminaire for low pressure capsule lamps
- 10° or 25° reflector options
- Supplied with leading and trailing edge dimmable transformer



90mmØ		Beam	White Bezel	Silver Bezel	
50w QT12-LPax	10°		2030611	-	0.45kg
50w QT12-LPax	25°		2030612	2030616	0.45kg
90mmØ Housing only			White Bezel	Silver Bezel	
50w QT12-LPax			2030951	-	0.25kg
50w QT12-LPax			-	-	0.25kg

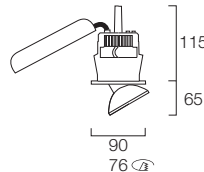
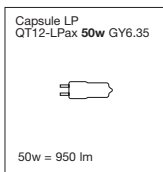
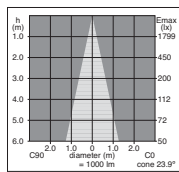
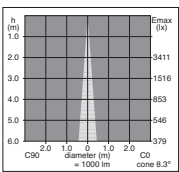

Myriad 4

BriteSpot

- Compact high output downlight with a cut out of just 76mm
- **All luminaires supplied complete with lamp, electronic gear and trim**
- 38° luminaire with low glare multigroove baffle
- 60° luminaire with high output sloped baffle
- BriteSpot™ lamp has approximately 3 times the output of a tungsten halogen equivalent
- 6,000 hours lamp life (50% more than most MR16s)
- Not suitable for use with other Myriad 4 accessories



	White	Satin Chrome	Bright Chrome	
35w HIPAR51 38°	2034964	2034966	2034967	0.47kg
35w HIPAR51 60°	2034955	2034956	2034957	0.47kg

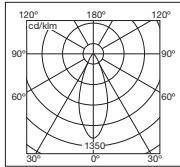

DLOR = 0.64
BriteSpot 38°

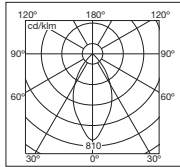
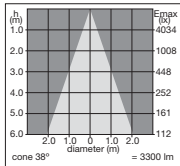

DLOR = 0.52
BriteSpot 60°

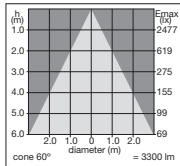

BriteSpot ES50
HIPAR51 35w GX10

35w = 3300 lm

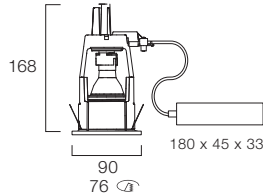

60° Sloped Baffle



38° Multigroove baffle

Myriad 4

Myriad Compact

- HF control gear
- Compact fluorescent low energy downlight
- Myriad compact emergency version passes through ceiling cut out
- Ideal for low level orientation lighting
- Wide choice of decorative accessories



TC-D Housing



Housing	Emergency		
18w TC-TEL		2037234	0.22kg
18w TC-TEL	Remote	2037235	0.22kg

For technical details of emergency options see page 88

Metal Tile Ceiling Ring

For fixing into metal ceiling tiles. 105mm ceiling cut-out

	2010437	0.13kg
--	----------------	--------

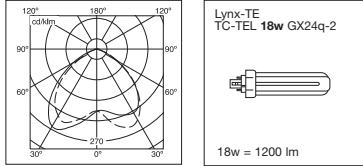
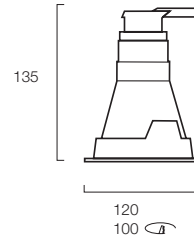

DLOR=0.60 2037234

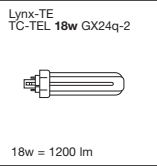

18w = 1200 lm



Ceiling Ring

Myriad 4

Myriad Compact



Bezel + Cover Glass



Bezel + Opal Dish



Bezel + Floating Clear Glass



Bezel + Metal Ring



Bezel + Frosted Deep Ring

120mmØ Accessories Order separately	White	Satin Chrome	Bright Chrome
Bezel Only	2017415	2017414	-
Bezel + Cover Glass	2017419	2017418	-
Bezel + Opal Dish	2017436	2017435	-
Bezel + Floating Clear Glass	2017453	-	-
Bezel + Metal Ring	-	2017438	-
Bezel + Frosted Deep Ring	2017430	2017428	2017426
Bezel + Spill Ring	2017447	-	-

Myriad 4

Myriad 50 Emergency

Three luminaires in the range are available with emergency options, these are supplied as a complete pack consisting of the Myriad 50 housing, a 50w transformer and 3 hour battery pack. The LED indicator supplied should be positioned alongside the luminaire and monitors both battery charging and lamp filament condition.



- **REMEMBER: Order the bezel required in addition to the emergency luminaire pack**
- The battery pack does **NOT** fit through the luminaire cut-out. Access to the ceiling void is required in order to install the pack which is relatively large (320 x 230 x 110mm) and heavy (13kg) as it is designed to run a 50w lamp for 3 hours in the event of mains failure. Hence it may not be suitable for all applications. Other emergency products such as the 10w Routelite can be used if there is no access to the ceiling void.

Myriad 50

Low Glare Housing Emergency Order Bezel separately see page 83

50w QT12-LPax	Silver Reflector	2030824
Includes: 168mm deep Myriad 50 housing c/w 50w transformer and 3hr battery pack		

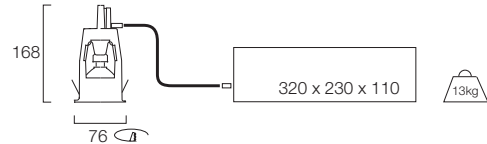

Myriad 50

For Shallow Ceiling Voids Emergency Order Bezel separately see page 83

50w QT12-LPax	Silver Reflector	2030823
Includes: 115mm deep Myriad 50 housing c/w 50w transformer and 3hr battery pack		

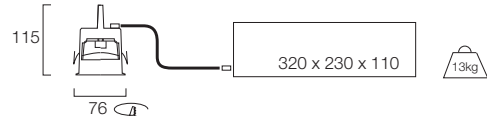

Myriad 50

Dichroic Emergency Order Bezel separately see page 83

50w QR-CBC51	Includes: 115mm deep Myriad 50 Dichroic housing c/w	2030825
50w transformer and 3hr battery pack		

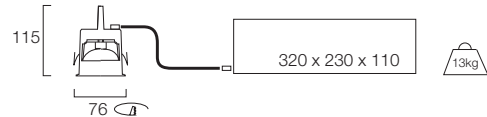

Myriad 4

Myriad Compact Emergency

The Myriad Compact emergency is supplied as a complete pack consisting of the Myriad Compact housing, inverter, LED indicator and 3hr battery pack in two parts which passes through the luminaire cut-out.



- **REMEMBER: Order the bezel required in addition to the emergency luminaire pack**

Myriad Compact Emergency Order Bezel separately see page 87

18w TC-TEL	Includes: 135mm deep Myriad Compact housing c/w inverter and 3hr battery pack	2037235
------------	---	----------------

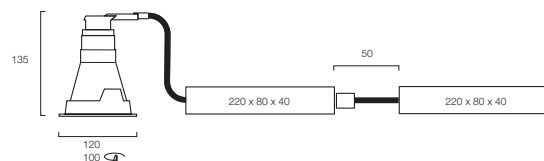

RouteLED

- Miniature ceiling recessed non maintained 3hr emergency 1w accent LED downlight with green charge indicator
- Stand alone unit complete with inverter module and Nickel Metal Hydride battery pack
- Inverter and battery pack pass through the luminaire cut out
- Quick and easy installation with simple plug and socket connections
- Maintained solutions supplied on request

RouteLED – Supplied c/w 1w Luxeon LED 110°

	White	Silver
350mA 1w Luxeon LED 110°	9141248	9141552

Control Gear: Remote 3hr non non maintained
 Battery: 3 x 2.1Ah NiMH
 Output Current: 350mA
 LED: Luxeon 1w 110° white 6000K
 Emitter Luminous Flux: 32 lumens

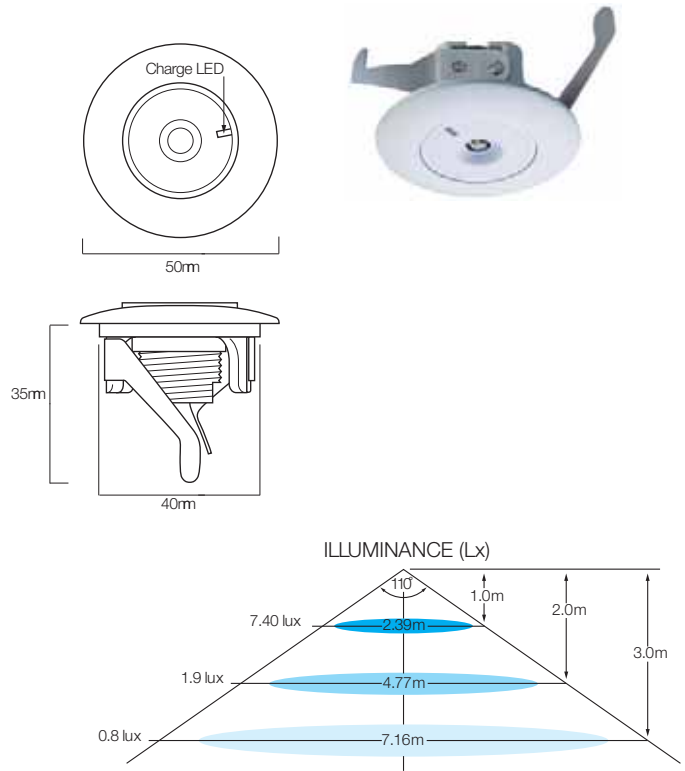

Routelite Emergency

- Discreet emergency lighting
- Ideal for defined escape routes where standard luminaires cannot provide emergency illumination
- Installation from below the ceiling: easy maintenance
- Fits through 89mmØ hole and within 120mm void
- Conforms to disability glare requirements



Routelite Emergency Kit – Supplied c/w Housing, 10w TH capsule lamp, Battery Power Pack and Non-maintained Inverter

	Emergency		
10w QT9-LPax	Remote	4042218	2.75kg

Remote Control Box – (Central Battery) 3hr Non-maintained

2 x 10w QT9-LPax	4001635	9.00kg
5 x 10w QT9-LPax	4001638	15.00kg

Control Gear: Remote, 3hr non-maintained
 Diffuser: Glass, frosted
 Housing/Trim: Flame retardant thermoplastic UL94 V0, integral LED charge indicator
 Retaining Springs: Spring steel
 Remote Control Box: Steel, stoved white. Integral inverter and batteries
 Power Pack: Pre-wired inverter and battery pack

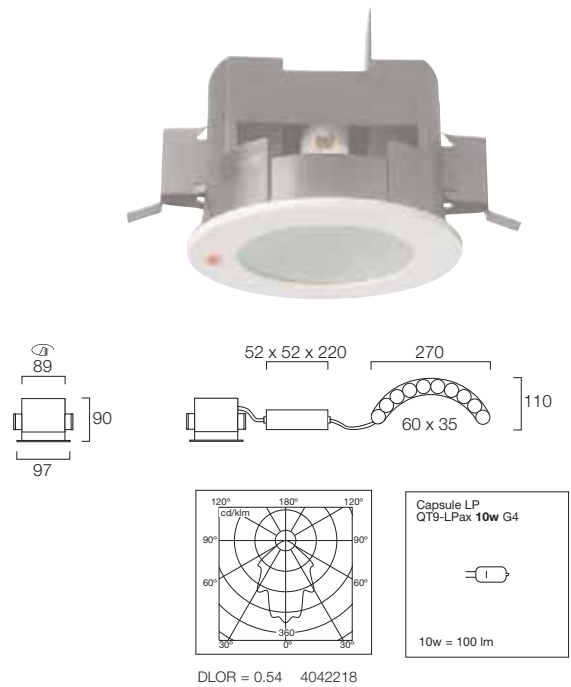

Local Mounting Example

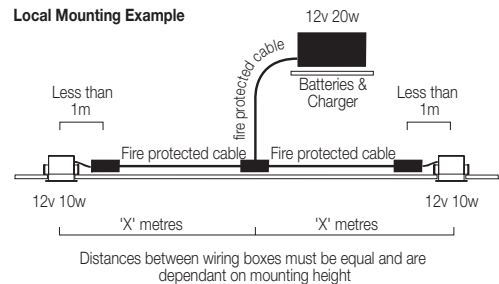



Cassini



- Two contemporary styles – Planer and Radius
- Satin glass effect diffuser for high LOR and excellent diffusion
- Ceiling or wall mounted
- Integral emergency options – suitable for use on defined escape routes
- Halo backlight
- Tamper resistant locking feature
- IP65 for wet areas
- Matching pendant (See page 205)

Control Gear:	Integral electronic gear
Emergency:	Integral, 3hr maintained
Diffuser:	Polycarbonate, satin opal, UV stabilised
IP65 Housing:	Polycarbonate, clear
Housing/Trim:	Aluminium, powder coated white RAL 9016 or brushed aluminium

Cassini

Planar

- Halo backlight
- IP65 fitting resistant to dust and water jet ingress
- Tamper resistant locking feature
- Ceiling or wall mounted
- Integral emergency options – suitable for use on defined escape routes
- Low profile fitting
- Choice of white and brushed aluminium trim finishes
- High frequency gear



400mmØ	Emergency	White	Brushed Aluminium	
28w TC-DD		4065211	4065212	1.35kg
28w TC-DD	Integral	4065213	4065214	2.35kg
2x18w TC-DEL		4065219	4065220	1.70kg
2x18w TC-DEL	Integral	4065221	4065222	2.70kg

500mmØ	Emergency	White	Brushed Aluminium	
38w TC-DD HF		4065269	4065270	2.15kg
38w TC-DD HF	Integral	4065271	4065272	3.15kg
2x26w TC-DEL		4065277	4065278	2.50kg
2x26w TC-DEL	Integral	4065279	4065280	3.50kg

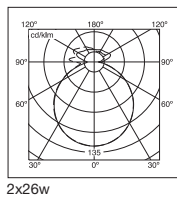
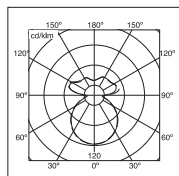
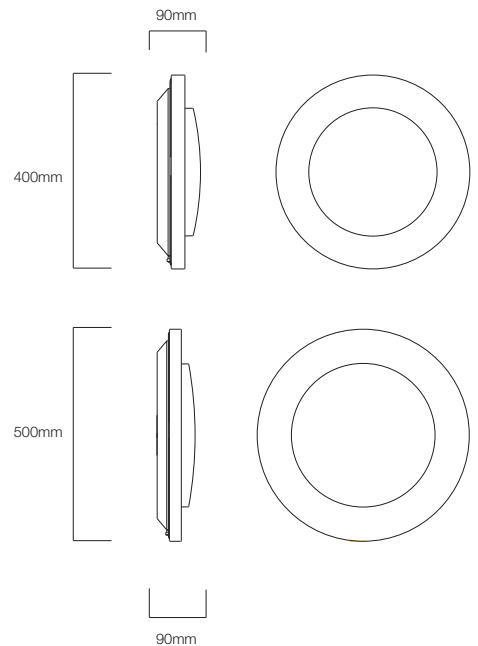

Matching Cassini
Planar Pendant –
See page 206

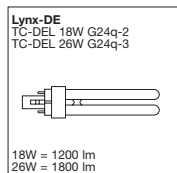
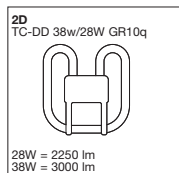

Cassini

Radius

- Halo backlight
- IP65 fitting resistant to dust and water jet ingress
- Tamper resistant locking feature
- Ceiling or wall mounted
- Integral emergency options – suitable for use on defined escape routes
- Low profile fitting
- Choice of white, brushed aluminium and chrome trim finishes
- High frequency gear



400mmØ	Emergency	Chrome	White	Brushed Aluminium	
28w TC-DD		4065621	4065215	4065216	1.35kg
28w TC-DD	Integral	4065622	4065217	4065218	2.35kg
2x18w TC-DEL		4065623	4065223	4065224	1.70kg
2x18w TC-DEL	Integral	4065624	4065225	4065226	2.70kg

500mmØ	Emergency	Chrome	White	Brushed Aluminium	
38w TC-DD HF		4065625	4065273	4065274	2.15kg
38w TC-DD HF	Integral	4065626	4065275	4065276	3.15kg
2x26w TC-DEL		4065627	4065281	4065282	2.50kg
2x26w TC-DEL	Integral	4065628	4065283	4065284	3.50kg

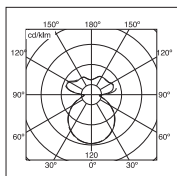
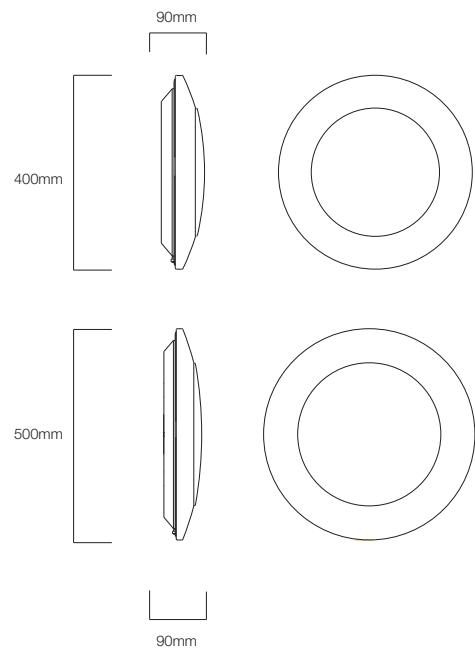

28w

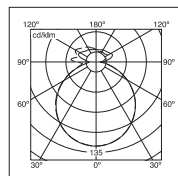

2x26w



Matching Cassini
Radius Pendant –
See page 207

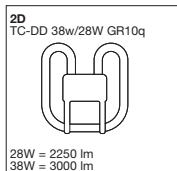

28W = 2250 lm
38W = 3000 lm

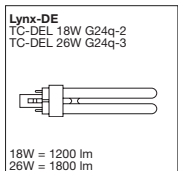

18W = 1200 lm
26W = 1800 lm

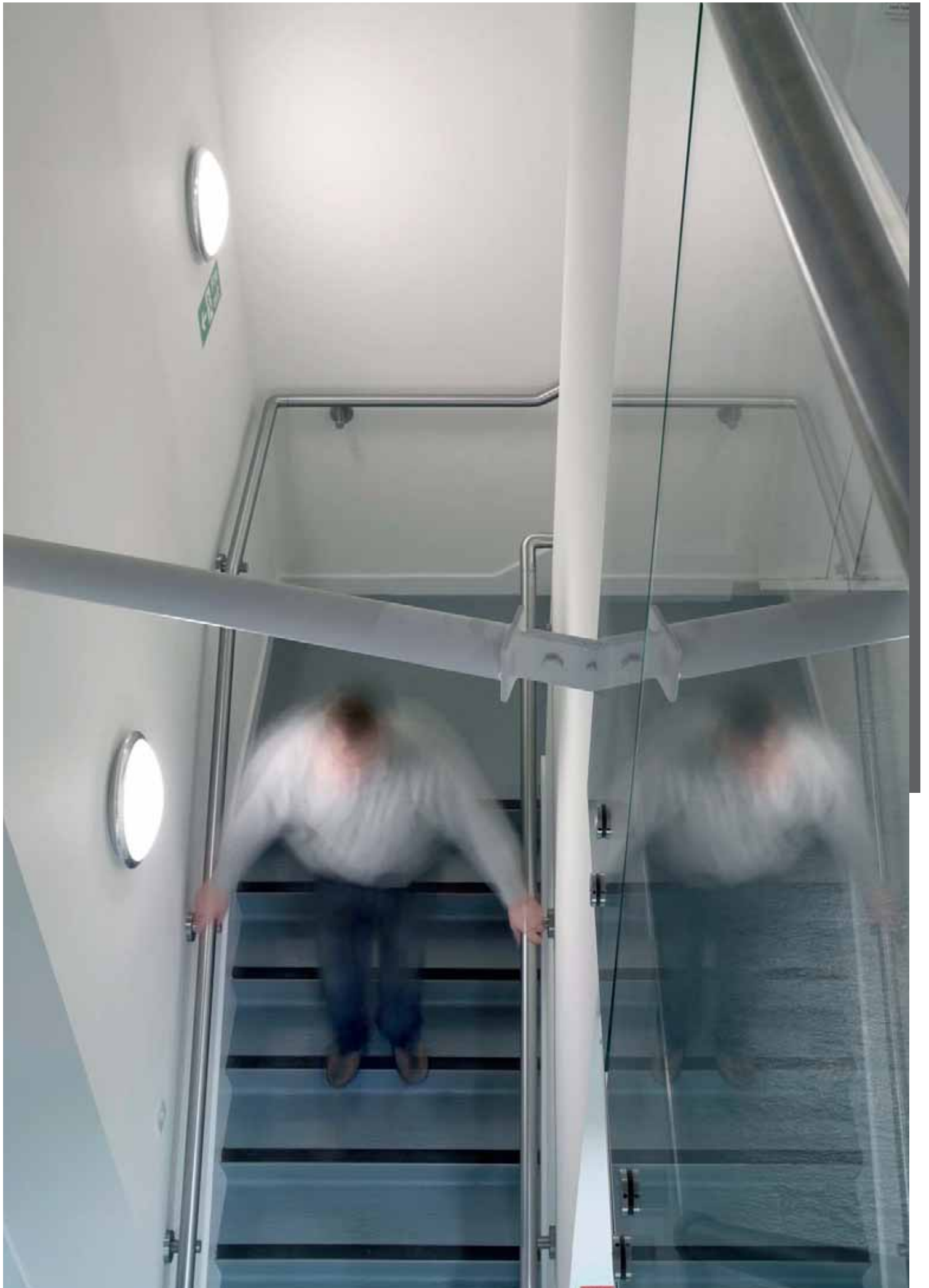

Opaline



- Three trim finishes: Chrome, brushed aluminium and white
- Opal diffuser providing even diffusion, eliminating glare spot
- Ceiling or wall mounted
- Integral emergency options – suitable for use on defined escape routes
- High-output 2x36w TC-F option

Control Gear: Integral electronic gear or switch start HPF
Emergency: Integral, 3hr maintained
Diffuser: Polycarbonate, opal or satin prismatic
Housing/Trim: Aluminium, powder coated white RAL 9016, brushed aluminium or polished clear lacquered for chrome effect.
Other RAL colours and finishes available to special order

Opaline

350mmØ

- Ceiling or wall mounted
- Optional prismatic diffuser
- IP 44 Kit for bathrooms and wet areas



350mmØ	Emergency	Gear	Chrome	White	Brushed Aluminium	
28w TC-DD		HF	4037972	4037958	4062818	0.80kg
28w TC-DD	Integral	HF	4056655	4056686	4062819	1.90kg

Accessories Order separately

Semi-recessing Kit	-	4037857	Not suitable for 28w TC-DD emergency		
IP44 Kit		4056592	Upgrades standard Opaline to IP44		
Prismatic Diffuser		4033350			

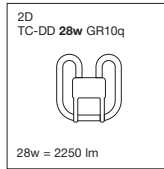
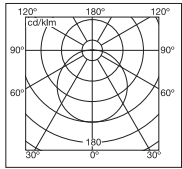
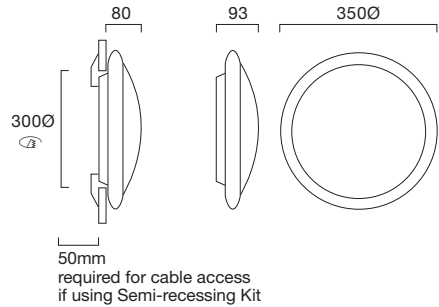

Prismatic Diffuser for improved DLOR

28w

Opaline

450mmØ

- Ceiling or wall mounted
- Optional prismatic diffuser
- IP 44 Kit for bathrooms and wet areas
- Nightlight version



450mmØ	Emergency	Gear	Chrome	White	Brushed Aluminium	
38w TC-DD		HF	4038139	4038141	4062825	1.30kg
38w TC-DD	Integral	HF	4059895	4059903	4062826	2.70kg
2 x 18w TC-DEL		HF	4038145	4038147	4062832	1.85kg
2 x 18w TC-DEL	Integral	HF	4059869	4038418	4062834	2.85kg

Nightlight Version

2 x 18w TC-D + 5/7/9w TC-S	SS	-	4037422	4062835	2.40kg
----------------------------	----	---	----------------	----------------	--------

Accessories Order separately

Semi-recessing Kit	4037857	
IP44 Kit	4056720	Upgrades standard Opaline to IP44
Prismatic Diffuser	4064489	

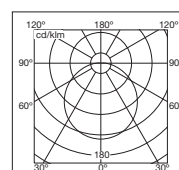
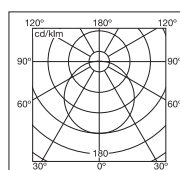
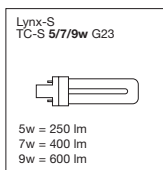
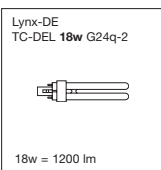
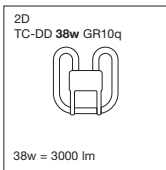

DLOR=0.44 ULOR=0.01 38w

DLOR=0.45 ULOR=0.01 2 x 18w

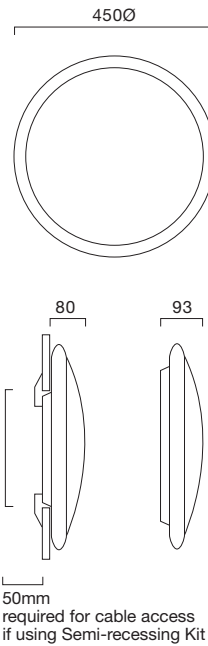

Opaline

550mmØ

- New high output 2x36w TCF versions
- Ceiling or wall mounted



550mmØ	Emergency	Gear	White	Brushed Aluminium	
2 x 26w TC-DEL		HF	4038205	4062848	2.25kg
2 x 26w TC-DEL	Integral	HF	4038422	4062850	3.25kg
2 x 36w TC-F		HF	4065661	4065662	2.25kg
2 x 36w TC-F	Integral	HF	4065663	4065664	3.25kg

Accessories Order separately

Semi-recessing Kit	4037858
--------------------	----------------

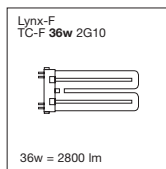
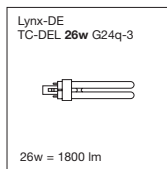

Brushed Aluminium

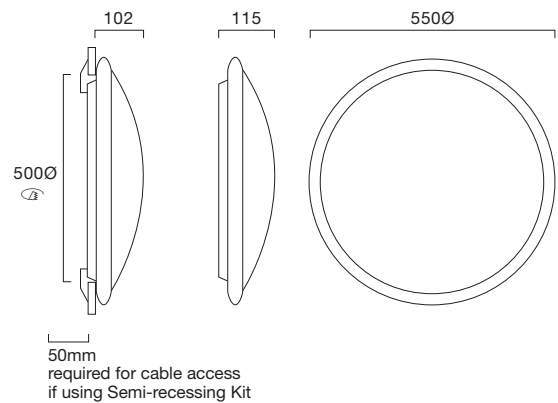

Antiligature Opaline

390mmØ, 490mmØ, 590mmØ

- Diffuser trim designed to reduce the opportunity for use as a ligature point
- Tamper resistant
- Opal diffuser providing even diffusion eliminating glare spot
- Ceiling or wall mounted
- HF Control gear and 1-10v analogue dimmable options as standard
- Integral emergency option
- Nightlight options



390mmØ	HF	Emergency	Dimmable	Nightlight
28W TC-DD	4065601	4065602	-	-

490mmØ	HF	Emergency	Dimmable	Nightlight
38W TC-DD	4065603	4065604	-	-
2x18W TC-DEL	4065605	4065606	4065607	4065608

590mmØ	HF	Emergency	Dimmable	Nightlight
2x26W TCD	4065609	4065610	4065611	4065612

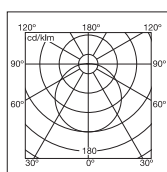

DLOR = 0.44
28w

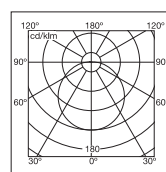

DLOR = 0.44 ULOR = 0.01
38w

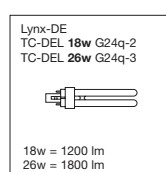
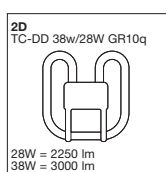

95mm
95mm
120mm

390mm
490mm
590mm

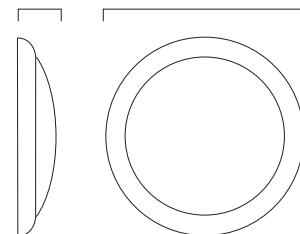

- Control Gear: Integral electronic gear or 1-10V analogue dimmer gear
- Emergency: Integral: 3hr maintained
- Diffuser: Polycarbonate opal
- Housing/Trim: Aluminium, powder coated white RAL 9016



Brio



- Satin glass effect diffuser for high LOR and excellent diffusion
- Ceiling or wall mounted
- Integral emergency options – suitable for use on defined escape routes
- White, silver and blue coloured versions
- Blue version features coloured halo backlight
- Tamper resistant locking feature
- IP44 for wet areas
- Complimentary IP65 exterior and vandal resistant versions see page 223

Control Gear:

Integral electronic gear

Emergency:

Integral, 3hr maintained

Diffuser:

Polycarbonate, satin opal

IP44 Housing/Trim:

Polycarbonate, white, silver or blue

Brio

IP44

- Crisp white, silver and translucent blue versions
- Blue version creates a coloured halo effect
- Tamper resistant locking feature
- IP44 for wet areas



Standard	Emergency	White	Silver	
28w TC-DD		4057627	4057630	1.25kg
28w TC-DD	Integral	4057629	4057632	2.15kg

Coloured Halo	Emergency	Blue	
28w TC-DD		4060726	1.25kg
28w TC-DD	Integral	4060728	2.15kg

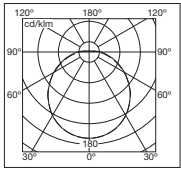
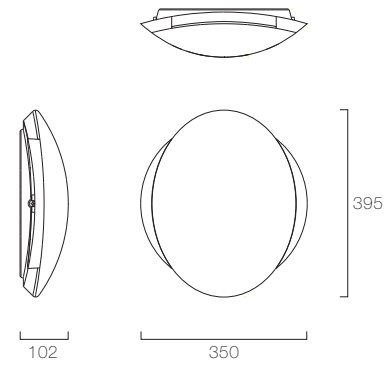

DLOR = 0.53 28w

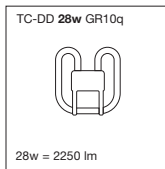

TC-DD 28w GR10q
28w = 2250 lm

Elite

Shaverlight & Luminaire

- Supplied complete with Sylvania Lynx-S (TC-S) long life lamp (10,000hr)
- Concealed and protected dual voltage shaver socket
- White, silver or gold trim
- Separate switching for lamp and shaver socket
- Horizontal or vertical mounting



		White	Chrome	Gold	
11w TC-S	Push Plate + Shaver Socket	2425707	2425708	2425709	1.40kg
11w TC-S	Pull Cord + Shaver Socket	2425713	2425714	2425715	1.40kg
11w TC-S	Push Plate Only	2425716	2425717	2425718	1.40kg
11w TC-S	Pull Cord Only	2425719	2425720	2425721	1.40kg

Control Gear: Integral switch start ballast and shaver safety isolating transformer in accordance with IEC 61558 (IEC 742)

Body/Diffuser: Polycarbonate, white and opal respectively

Back Plate/ Decorative Ends: ABS, white

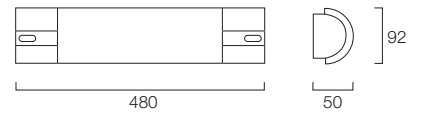

White



Chrome



Gold



Pull Cord



Shaver Socket

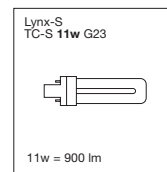

Syl-Safe IP65

- IP65 polycarbonate body
- Clear fresnel lens
- 100lm output
- Ceiling or wall mounted
- Interior or exterior
- Self test luminaires available to order
- Recessing kit
- Suspended sign kit



Applications

Designed for indoor or outdoor applications for commercial and industrial locations. Suitable for defined escape routes.

Syl-Safe IP65	Non-maintained	Maintained
T5 8W	9136512	9136514

Syl-Safe IP65 Self Test	Non-maintained	Maintained
T5 8W	9136513	9136515

Recessing Kit	9136516	
---------------	----------------	--

Suspended sign kit	Single sided	Double sided
Arrow down	9137000	9137003
Arrow left	9137001	9137004
Arrow right	9137002	9137005

Specification

Operation	Non-Maintained	Maintained	Mains only
Light source	1 x 8Watt T5		
Construction <i>standard</i>	Grey polycarbonate base and clear fresnel lens		
Light output (emergency)	-	100lm	400lm
<i>standard</i>			
Battery <i>standard</i>	2.4V 4AH NiCd		
Charge current	250mA normal		
Recharge period	24hours (14hrs for 1hr duration)		
Input voltage	230Volt +/-10% ~ 50Hz		
Power	9VA (max.)	21VA (max.)	13VA

Mounting height Hm (m)to wall	Trans. to trans	Trans. to trans	Axial to trans	Axial to Axial	Axial to wall	
2.5	2.0	6.9	6.1	3.6	1.1	1Lux min.
4.0	1.5	5.7	5.3	3.4	0.5	at centre
2.5	3.4	9.7	8.0	5.2	1.7	0.5Lux min.
4.0	2.5	9.5	7.8	5.0	1.0	(open)

Description

White flame retardant body and lens impact resistant. Hinged gear tray for ease of installation and maintenance



Suspended sign kit

Recessing kit

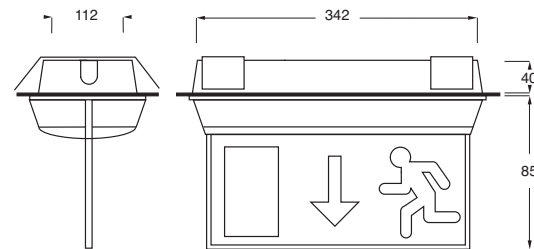
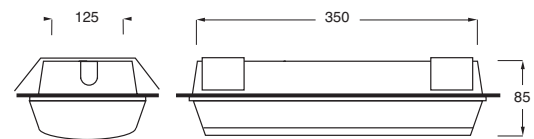

Cut-out size 343 x 116

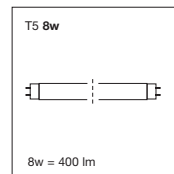

Syl-Safe Surface and Suspended

- Slimline white steel housing
- Wall or flush ceiling mounted
- Interior IP20 applications
- Self test luminaires available to order



Wall mounted exit



Flush mounted exit



Applications

Designed for interior applications for commercial and industrial applications

Wall Mounted Exit	Non-maintained	Maintained
T5 8W	9136522	9136524
Wall Mounted Exit Self Test	Non-maintained	Maintained
T5 8W	9137011	9137012
Flush Mounted Exit	Non-maintained	Maintained
T5 8W	9137006	9137007
Flush Mounted Exit Self Test	Non-maintained	Maintained
T5 8W	9137008	9137010

Standard exit signs supplied with 'Arrow down' legend.

Order left or right legends if required

Wall Mounted Exit Sign Legend	
Legend only arrow left	9137834
Legend only arrow right	9137835

Flush Mounted Exit Sign Legend	
Legend only arrow left	9137832
Legend only arrow right	9137833

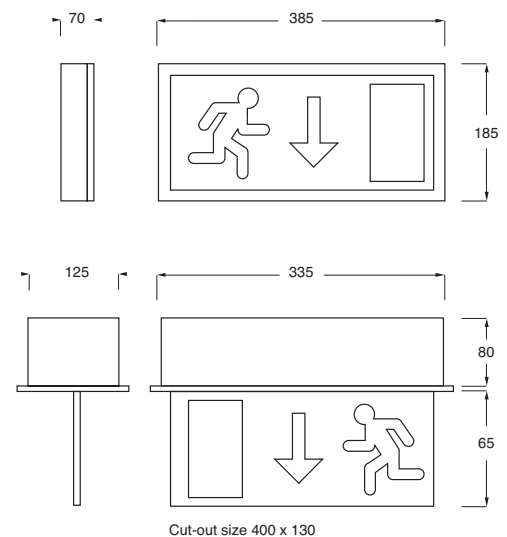

Cut-out size 400 x 130

Specification

Operation	Non-Maintained	Maintained	Mains only
Light source	1 x 8Watt T5		
Construction	Steel enclosure and gear tray with screen printed polycarbonate legend panel		
Light output (mains)	-	100lm	400lm
Light output (emergency)	400lm	100lm	-
Battery	2.4V 4AH NiCd		
Charge current	250mA normal		
Recharge period	24hours (14hrs for 1hr duration)		
Input voltage	230Volt +/-10% ~ 50Hz		
Power	9VA (max.)	21VA (max.)	13VA

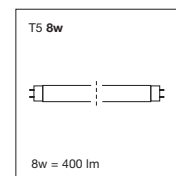

Description

White painted metal housings. Silk screened legend panels. Supplied arrow down as standard



Torus

Recessed



Torus 100FX Spot Recessed

- Compact range of low voltage and high output recessed adjustable downlights. (Spotlights see page 137)
- Shallow recess depth
- 360° rotation and 45° tilt
- Lightweight remote electronic control gear and transformers with plug and socket connection
- Lockable head and focussing
- Broad range of interchangeable accessories, lenses and filters
- Effects are easily changed and updated to suit application

Control Gear:

HIT: Electronic gear with timed ignition and thermal cut out

LV: Electronic transformer with thermal cut out, and dimmable with leading and trailing edge dimmers

Reflector:

Aluminium (Fixed on metal halide version, removable on low voltage option)

Safety lens:

Borosilicate glass

Housing:

Die-cast aluminium, lightweight alloy

Bezel:

Die-cast aluminium (Inner holder polycarbonate and silicone)

Filters:

Glass

Accessories:

Aluminium, steel, glass

Finish:

Smooth polyester powdercoat paint finish in white RAL 9016, silver RAL 9006 or black RAL 9005

Torus BriteSpot 50

Metal Halide Recessed

- High output miniature adjustable downlight
- 35w BriteSpot ES50 (HIPAR51) metal halide lamp
- Square fronted Quads with single, twin, triple and quadruple lamp modules
- 100% more output than 50w Dichroic lamp
- Crisp, clean 38° beam
- Snap fit cowl accessory for reduction of peripheral glare
- **Supplied with Sylvania 35w BriteSpot 38° ES50 lamp**



Quads	White	Silver	
1 x 35w HIPAR51	2034718	2034723	0.81kg
2 x 35w HIPAR51	2034720	2034724	1.62kg
3 x 35w HIPAR51 Quad	-	2034725	2.43kg
4 x 35w HIPAR51 Quad	2034722	2034726	3.24kg

NOTE: Cannot be mounted on vertical surface or floor
 Torus BriteSpot 50 cannot be used with colour filters or projector accessories

Accessories

Glare Cowl	2028580
------------	----------------



35w 38° Flood

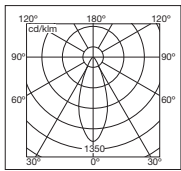

DOOR = 0.64

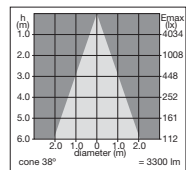

35w 60° Flood

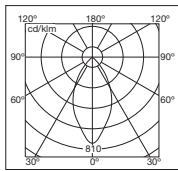

DOOR = 0.52

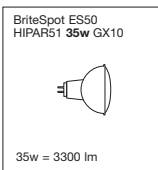
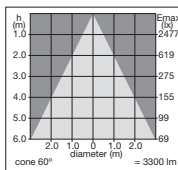

Torus Spotlights also available. See page 137

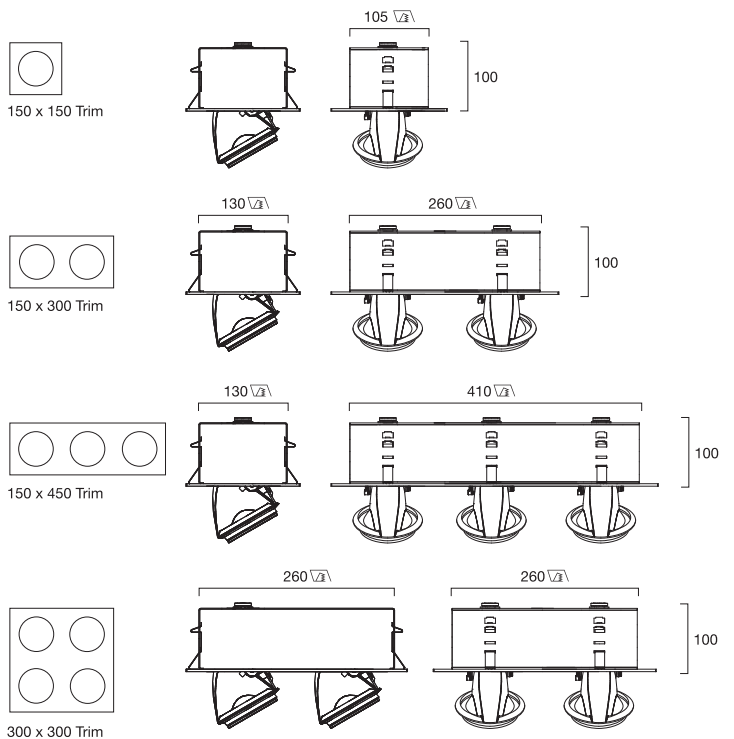

Torus 50FX

Low Voltage Recessed

- Low voltage miniature adjustable downlight
- 25-50w low voltage tungsten halogen capsule lamps
- Square fronted Quads in single, twin, triple or quadruple lamp modules
- Collectively dimmable using leading and trailing edge dimming systems
- Lens assemblies provide beams from 10° to 42° plus elongation – **order separately**
- Broad range of interchangeable filters and accessories.
- **Order lamp separately**



Quadruple Quad with Honeycomb Filter/ Projector Arm Accessory



Quads Order Safety Lens Assembly separately

	White	Silver	
1 x 50w QT12-LPax	2034710	2034714	0.81kg
2 x 50w QT12-LPax	2034711	2034715	1.62kg
3 x 50w QT12-LPax	2034712	2034716	2.43kg
4 x 50w QT12-LPax	2034713	2034717	3.24kg

Safety Lens Assembly Order in addition to Housing

Spot	10°	2030818
Flood	25°	2030822
Wide Flood	42°	2030821
Elongation	3:1	2030820

50w 10° Spot + Lens Assembly

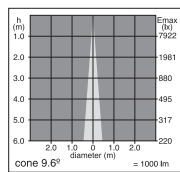

50w 25° Flood + Lens Assembly

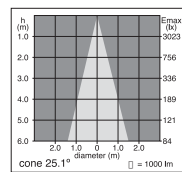

Capsule LP QT12-LPax 50w GY6.35

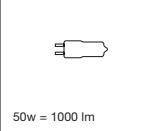

Torus Spotlights also available. See page 137

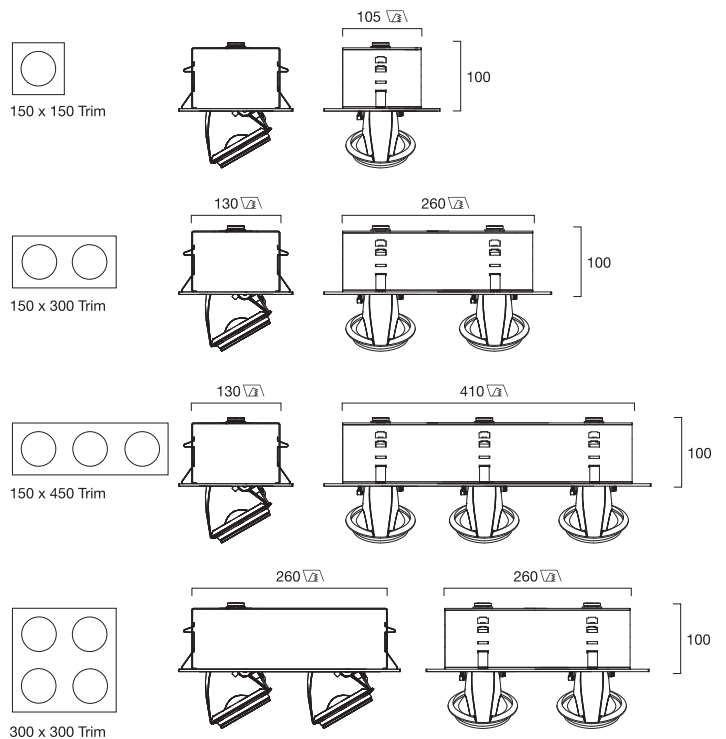

Torus 50FX

Accessories

- Twist lock lens assemblies consisting of reflector and front safety lens provide beams from 10° to 42°
- Screw fit filters
- Snap fit shield accessory



As with Torus spotlights coloured filters, barn doors and gel filter holder simply screw-fit onto front bezel



Optional snap-fit glare shield



Bezel easily removed to allow quick lamp replacement or accessories to be fitted

Optional Accessory



Glare Shield



Optional Lens Assemblies

Spot	10°	2030818
Flood	25°	2030822
Wide Flood	42°	2030821
Elongation	3:1	2030820

Optional Filters



Optional Filters

Honeycomb	Not to be used in combination with colour filters	2028586
UV	100% UVB/C and UVA protection	2028584
Daylight	Converts 3000k to 6000k	2028585
Red		2028581

Other colours on request. Up to 2 filters can be stacked (Honeycomb must be at the front).

Low Glare Spot cannot be used with Honeycomb or Coloured Filters.

Colour Filters cannot be used in combination.

Optional Accessory

Glare Shield	Black	2028580
--------------	-------	----------------

Torus 50FX

Projector Arm Accessories

- Projector arm consisting of pin, cowl and arm
- Four framing plates adjust to provide projection of any four sided shape
- Iris plates in three different sizes
- Hard or soft focusing from adjustment at front or arm

Projector Accessory Arms

Projector arm accessories converts 25° Flood to Mini-Projector

	White	Black	
Framing Accessory Arm	2028588	2028590	0.20kg
Iris Accessory Arm	2028591	-	0.20kg

Iris Accessory Arm comes complete with 3 different sized Irises



Optional projector arm for framing, irises or gobos



Precise projector lens focusing facility



Easily adjustable framing head



Interchangeable irises in three sizes

Projection Sizes and Output

Head	Distance	Narrow Iris	Medium Iris	Wide Iris	Lux/Klm
Iris (Øm)	1m	0.15	0.25	0.39	1500
	2m	0.32	0.55	0.82	315
	3m	0.48	0.80	1.28	140

Head	Distance	max	min	Lux/Klm
Framing (m²)	1m	0.17	0.03	1500
	2m	0.34	0.05	315
	3m	0.66	0.10	140

Torus 100FX

Low Voltage Recessed

- 100mm recessing depth
- 50-100w tungsten halogen axial filament capsule lamp
- Electronic transformer and housing prep-wired with universal plug for easy installation
- Collectively dimmable using trailing and leading edge dimming systems
- Lamp focusing facility and lockable head
- Adjustable 45° tilt and 360° rotation
- Wide range of filters, accessories and control lenses to customise displays or accent interiors
- **Supplied with Sylvania 100w axial filament lamp**



Low Glare Spot



Recessed Torus 100FX Complete with transformer

		White	Luminaire	Transformer
100w QT12-LPax	Low Glare 8-14°	2039045	2.00kg	0.30kg
100w QT12-LPax	Flood 34°	2039047	2.00kg	0.30kg

Recessed Torus 100FX Housing Only

		White	Luminaire	Transformer
100w QT12-LPax	Low Glare 8-14°	2039107	2.00kg	-
100w QT12-LPax	Flood 34°	2039108	2.00kg	-

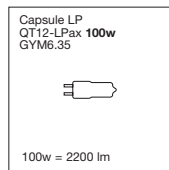
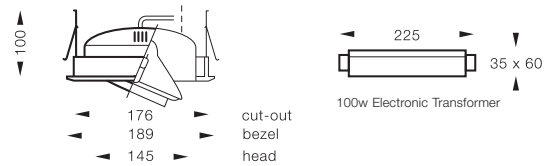

Torus 100FX Spotlights, see page 144

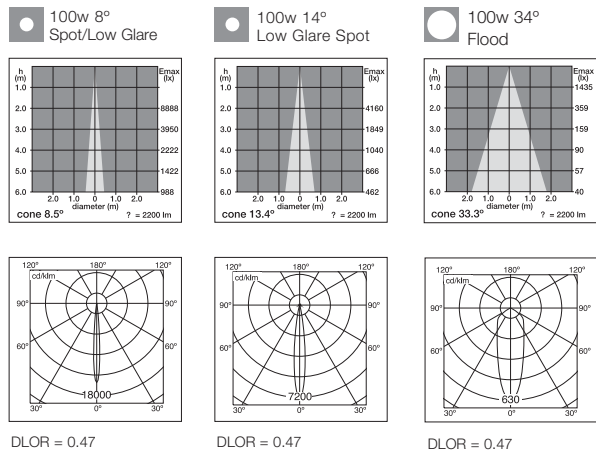

Torus 100FX

Accessories

- Interchangeable safety lenses, wattage and 100FX reflectors provide beam options from 6-60°
- Elongation safety lens for highlighting sculptures, mannequin, logos and shelving
- Coloured filters and gel filter holder for creating dramatic effects and highlighting displays
- Honeycomb filter, screw-fit glare shield and barn door accessories for effective glare control
- A combination of accessories can be fitted but must always include a safety lens next to the lamp



As with Torus spotlights, interchangeable control lenses and filters simply **push-fit** into new die-cast holder design



Optional barn door, glare shield and gel filter holder easily **screw-fit** onto front of holder



Bezel easily removed to allow quick lamp replacement or accessories to be fitted



Optional elongation lens rotates in any axis whilst in operation

Interchangeable Safety Lenses and Reflectors

	100w QT-ax	Wide Reflector 2020178	Narrow Reflector 2020177	
Spot Lens	8-12°	–	6°	2027238
Low Glare Lens	8-14°	24°	6°	2031577
Flood Lens	34°	60°	–	2027234
Medium Lens	24°	–	–	2033450
Wide Flood Lens	58°	–	–	2032480
Elongation Lens	5:1	6:1	4:1	2027239

Optional Filters

Honeycomb	Not to be used in combination with colour filters	2027240
UV	100% UVB/C and 70% UVA protection	2027241
Daylight	Converts 3000k to 6000k	2027246
Flesh Tone	Enhances the appearance of flesh tone, vegetables and meat	2032127
Mid Blue		2032128
Red		2027244
Amber		2027245

Other colours on request. Up to 2 filters can be fitted into the accessory holder in addition to the Safety Lens (Honeycomb must be fitted at the front of the holder). Low Glare Spot cannot be used with Honeycomb or Coloured Filters. Coloured Filters cannot be used in combination

Optional Accessories

		White	Silver	Black
Glare Shield	Reduction of peripheral glare	2032460	2032462	2032461
Barn Doors	Irregular control of light source	2032463	-	-

Can be used in combination with other filters.

Optional Safety Lenses

Spot 100FX



Low Glare 100FX



Medium



Flood

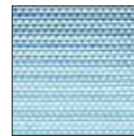

Wide Flood



Reflectors

Narrow Spot



Wide Flood



Optional Filters

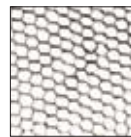

Honeycomb



UV



Daylight Correction



Flesh Tone



Mid Blue



Red



Amber

Optional Accessories



Glare Shield



Barn Doors

Torus 35/70FX

CMI/CDM Recessed

- Shallow recess depth allows installation in crowded ceiling voids
- Adjustable 80° degree tilt and 355° degree rotation
- Wide range of filters and accessories to allow customisation of lighting effects
- Interchangeable safety lenses produce spot, flood and elongation choices for optimum display lighting design flexibility
- Electronic gearbox smaller and lighter than conventional control gear
- Durable die cast housing and bezel
- **Order lamp separately**

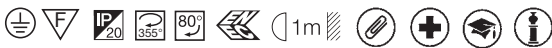

35FX CMI-TC		White	Black	Luminaire	Gear
35w HIT-TC-CE	Spot 10°	-	2039033	2.00kg	0.90kg
35w HIT-TC-CE	Flood 37°	2039036	-	2.00kg	0.90kg

70FX CMI-TC		White	Black	Luminaire	Gear
70w HIT-TC-CE	Spot 11°	2039038	-	2.00kg	0.92kg
70w HIT-TC-CE	Flood 39°	2039041	-	2.00kg	0.92kg

35FX CMI-T		White	Black	Luminaire	Gear
35w HIT-CE	Spot 11°	2039050	2039051		3.10kg
35w HIT-CE	Flood 28°	2039052	2039053		3.10kg

70FX CMI-T		White	Black	Luminaire	Gear
70w HIT-CE	Spot 12°	2039054	2039055		3.10kg
70w HIT-CE	Flood 29°	2039056	2039057		3.10kg

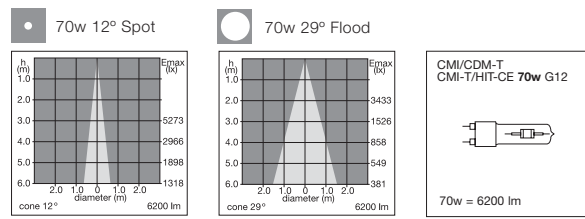
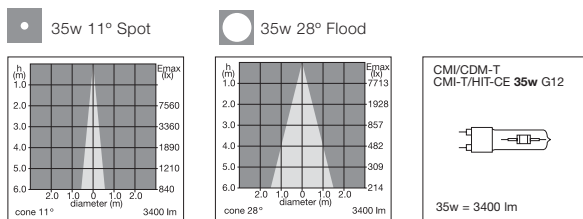
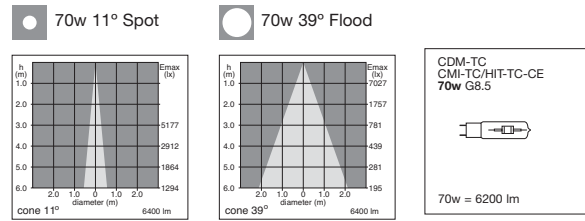
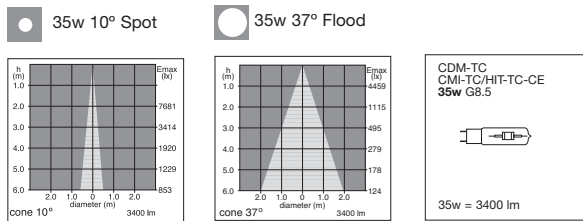
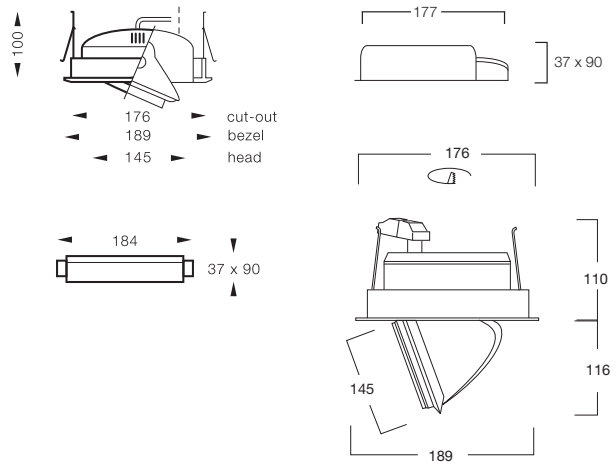

Torus 35/70FX

Accessories

- Interchangeable safety lenses provide beam angles from 10°-64°
- Elongation safety lens for highlighting sculptures, mannequin, logos and shelving
- Coloured filters and gel filter holder for creating dramatic effects and highlighting displays
- Honeycomb filter, screw-fit glare shield and barn door accessories for effective glare control
- A combination of accessories can be fitted but must always include a safety lens next to the lamp



As with Torus spotlights, interchangeable control lenses and filters simply **push-fit** into new die-cast holder design



Optional barn door, glare shield and gel filter holder easily **screw-fit** onto front of holder



Bezel easily removed to allow quick lamp replacement or accessories to be fitted



Optional elongation lens rotates in any axis whilst in operation

Interchangeable Safety Lenses

	35w	70w	
CMI/CDM-TC	CMI/CDM-TC	CMI/CDM-TC	
Spot Lens	10°	11°	2027238
Flood Lens	37°	39°	2027234
Medium Lens	20°	24°	2033450
Wide Flood Lens	60°	64°	2032480
Elongation Lens	5:1	5:1	2027239

Interchangeable Safety Lenses

	35w	70w	
CMI/CDM-T	CMI/CDM-T	CMI/CDM-T	
Spot Lens	11°	12°	2027238
Flood Lens	28°	29°	2027234
Elongation Lens	5:1	5:1	2027239

Optional Filters

Honeycomb	Not to be used in combination with colour filters	2027240
UV	100% UVB/C and 70% UVA protection	2027241
Daylight	Converts 3000k to 6000k	2027246
Flesh Tone	Enhances the appearance of flesh tone, vegetables and meat	2032127
Mid Blue		2032128
Red		2027244
Amber		2027245

Other colours on request. Up to 2 filters can be fitted into the accessory holder in addition to the Safety Lens (Honeycomb must be fitted at the front of the holder). Low Glare Spot cannot be used with Honeycomb or Coloured Filters. Coloured Filters cannot be used in combination

Optional Accessories

		White	Silver	Black
Glare Shield	Reduction of peripheral glare	2032460	2032462	2032461
Barn Doors	Irregular control of light source	2032463	2032464	2032465

Can be used in combination with other filters

Optional Safety Lenses

Spot



Elongation



Medium



Flood



Wide Flood



Optional Filters

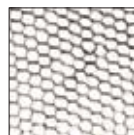

Honeycomb

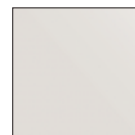

UV



Daylight Correction



Flesh Tone



Mid Blue



Red



Amber

Optional Accessories



Glare Shield



Barn Doors

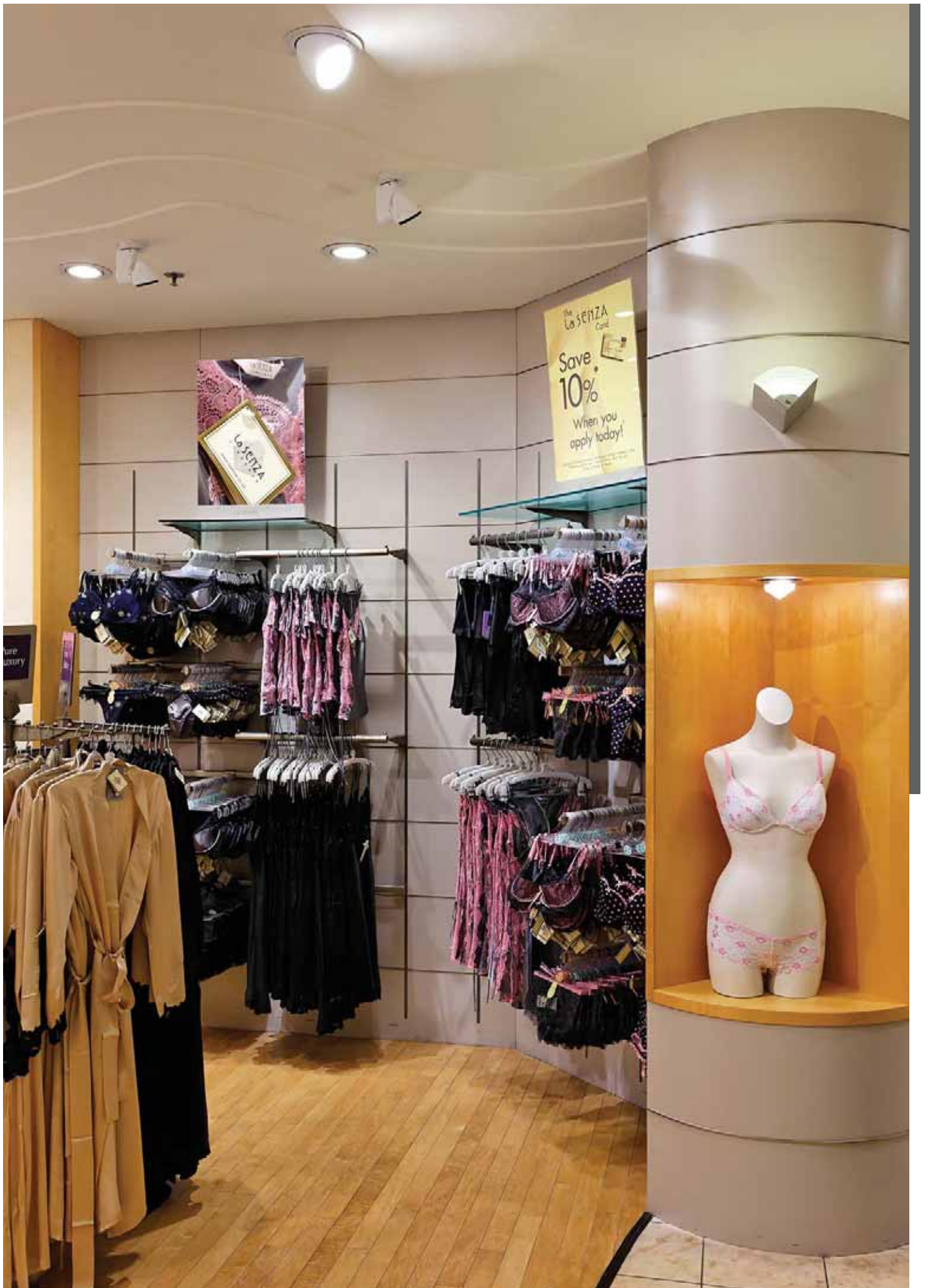

Storelyte

Recessed



Applications

- Shops
- Restaurants
- Hotels
- Offices
- Showrooms
- Reception Areas

- Capable of being fully recessed for clean ceiling lines
- Well established, reliable lamp technology
- Smooth friction action ensures selected tilt and rotation settings remain constant
- IP43 rating allows installation under canopies
- 15° and 60° reflector versions for display lighting flexibility
- Suitable for mounting into all common ceiling types
- Durable all metal construction
- Easy lamp change from the front. No need to access rear of fixture
- Reflector housing assembly equipped with retaining cable to allow hands free suspension during lamp change operations
- White only, silver versions available on request

Control Gear:

Wire wound/Electronic

Reflector:

Aluminium

Safety Lens:

Borosilicate glass

Housing:

All metal

Finish:

Powder coated smooth white RAL 9016

Storelyte

CMI/CDM-T 35/70w

- 350° rotation and 70° vertical tilt provides optimum display lighting flexibility
- White only, silver versions available on request
- **Order lamp separately**



WIRE WOUND

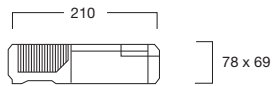

HIGH FREQUENCY

HF Gear
157 x 88 x 40



Storelyte	Ballast	15° spot	60° flood	
35w HIT-CE	Wire wound	2037885	2037887	2.85kg
70w HIT-CE	Wire wound	2037884	2037886	3.25kg
35w HIT-CE	High frequency	2039992	2039993	1.30kg
70w HIT-CE	High frequency	2039994	2039995	1.30kg
35/70w HIT-CE	Housing only	2039114	2039115	1.01kg

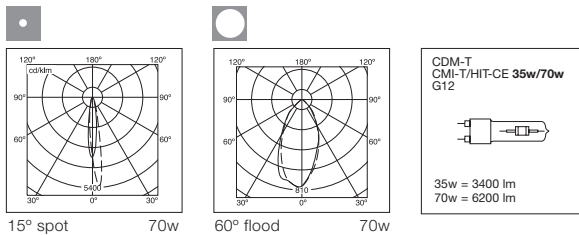
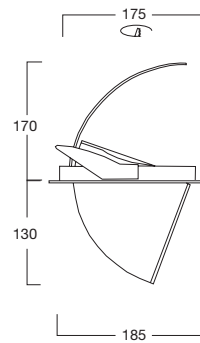

Storelyte X

- 350° Rotation and a total of 76° of vertical tilt, 38° out of the ceiling and 38° recessed into the ceiling provide optimum display lighting flexibility
- Secondary inner cowl provides optimum glare control but maintains clean ceiling line
- **Order lamp separately**



HF Gear
157 x 88 x 40

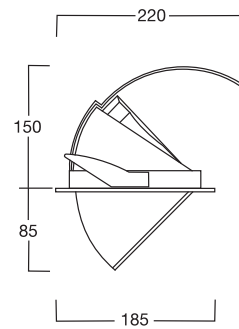
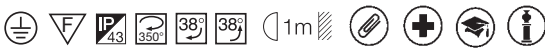

Storelyte	Ballast	15° spot	60° flood	
35w HIT-CE	High frequency	2041250	2041252	2.85kg
70w HIT-CE	High frequency	2041251	2041253	3.25kg
35/70w HIT-CE	Housing only			1.01kg

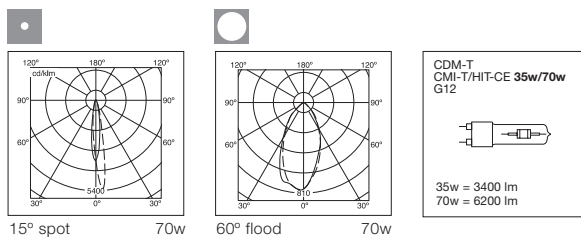

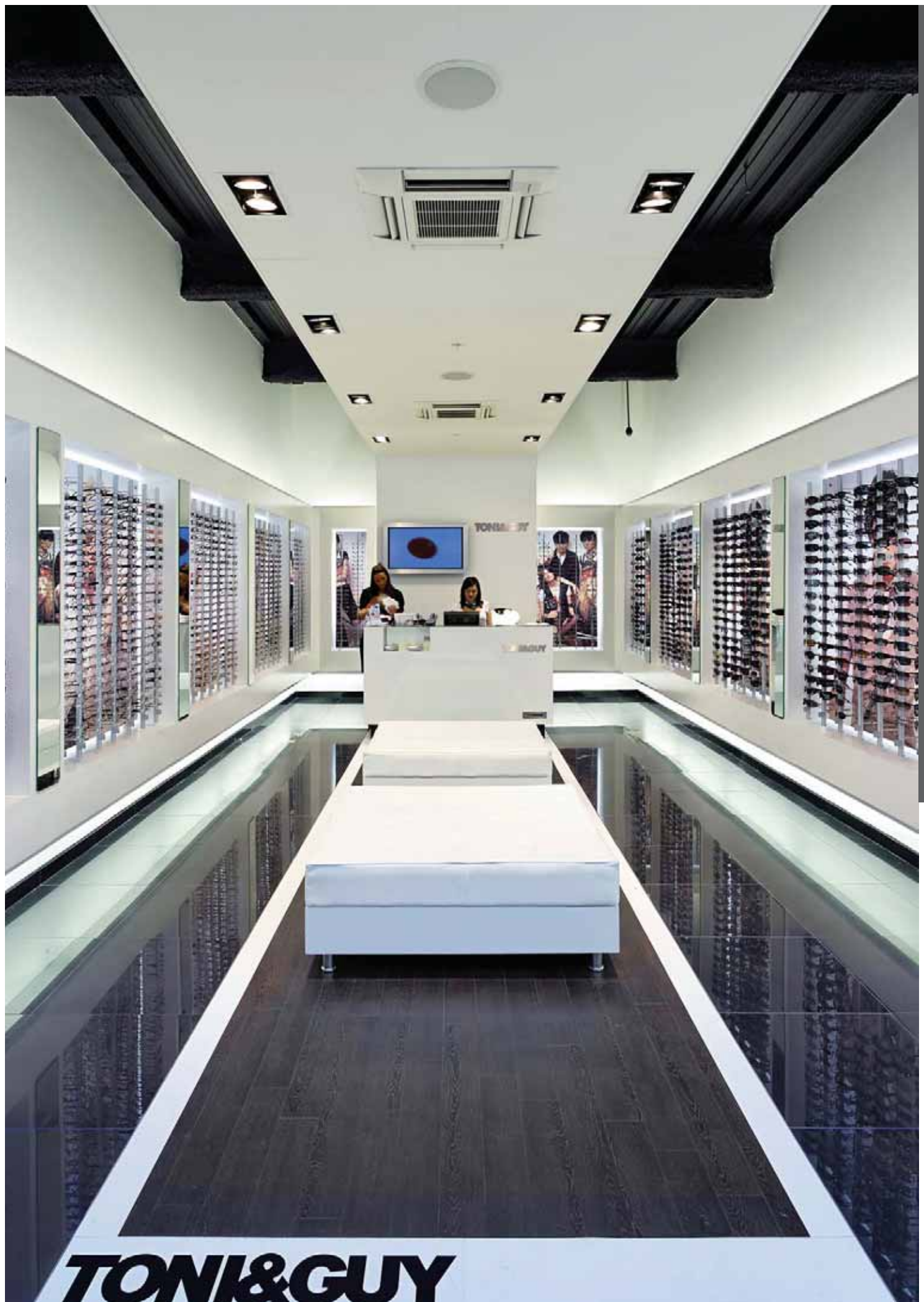

TONI & GUY

Lyteframe

Recessed



- Installation flexibility through a choice of single, twin, triple and quadruple lighting head fixtures available as standard
- High degree of adjustment through cardanic lighting head movement
- Choice of well established, easy to obtain light sources for the end user/lighting designer, including CMI/CDM-T and AR111 sources
- Reversible ceiling frame provides the choice to show trim or to plaster right up to the fitting

Mounting:	Recessed into ceiling
Control Gear:	Integral electronic gear with timed ignition and thermal cut-out
LV Transformer:	Integral electronic transformer with voltage regulation and thermal cut-out
Dimmable:	With leading & trailing edge dimmers
Frame:	Extruded aluminium, powder coated, white RAL 9016
Gimbal Assembly:	Powder coated die-cast aluminium, black RAL 9005
CMI/CDM-T:	Aluminium reflector Interchangeable borosilicate safety lens (order separately)

Recessed - Reflector Series

- Built in aluminium reflectors to dissipate heat and light forward
- AR111 dimmable using remote dimming
- Built in anti-glare mechanism
- Easy lamp installation and changing
- For accent and decorative lighting in retail, commercial and domestic applications
- BriteSpot ES111 offers a very high efficiency thanks to large reflector and patented anti-glare optics
- Gimbal adjusts to 45° in each direction
- **Order lamps separately**



AR111 Low Voltage

	White	
1 x 100w QR-LP111	2038923	1.20kg
2 x 100w QR-LP111	2038924	2.40kg
3 x 100w QR-LP111	2038925	3.60kg
4 x 100w QR-LP111	2038926	4.80kg
2 x 2 x 100w QR-LP111	2040251	4.80kg

BriteSpot ES111/ESD111 Metal Halide

1 x 35w HI-PAR111	2038927	1.30kg
2 x 35w HI-PAR111	2038928	2.50kg
3 x 35w HI-PAR111	2038930	3.70kg
4 x 35w HI-PAR111	2038931	4.90kg
2 x 2 x 35w HI-PAR111	2040252	4.90kg
1 x 70w HI-PAR111	2039092	1.30kg
2 x 70w HI-PAR111	2039093	2.50kg
3 x 70w HI-PAR111	2039094	3.70kg
4 x 70w HI-PAR111	2039095	4.90kg
2 x 2 x 70w HI-PAR111	2040253	4.90kg

CDM-R111 Metal Halide

1 x 35w CDM-R111	2038941	1.20kg
2 x 35w CDM-R111	2038942	2.40kg
3 x 35w CDM-R111	2038943	3.60kg
4 x 35w CDM-R111	2038944	4.80kg
2 x 2 x 35w CDM-R111	2040254	4.80kg

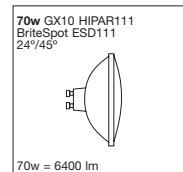
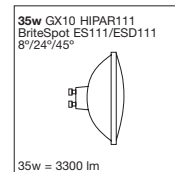
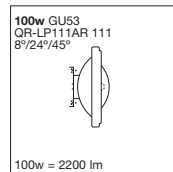
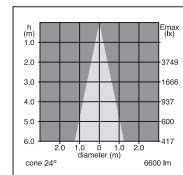
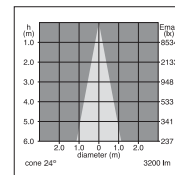
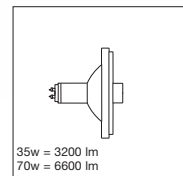

Suspended Lyteframe
See page 167

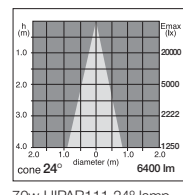
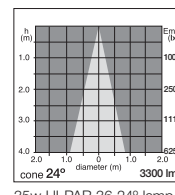
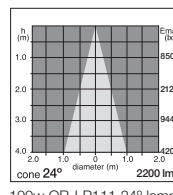

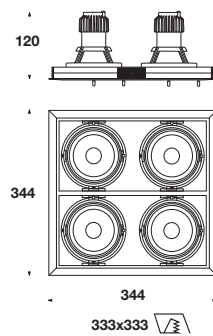
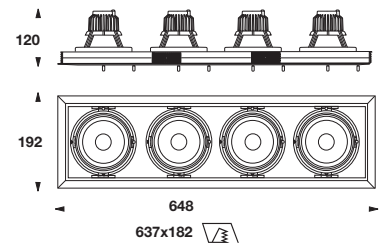
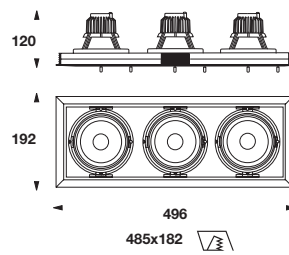
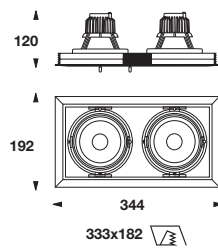
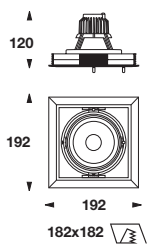

BriteSpot ES111/ESD111
patented anti-glare cowl



BriteSpot ES111/ESD111
user friendly 'twist' lock
GX10 lamp base



Lyteframe

Recessed - CMI/CDM-T

- Robust G12 based CMI/CDM-T ceramic metal halide capsule lamp
- Broad range of beam angle provided by interchangeable safety lenses - **order separately**
- Electronic control gear
- Ceramic arc tube ensures colour uniformity and stability throughout lamp life
- Very high luminous efficiency in a compact lamp format
- Good to excellent colour rendering properties
- UV-stop quartz reduces colour fading of merchandise
- Gimbal adjusts to 45° in each direction
- **Order lamps separately**



CMI/CDM-T

White

1 x 35w HIT-CE	2038932	1.20kg
2 x 35w HIT-CE	2038933	2.40kg
3 x 35w HIT-CE	2038934	3.60kg
4 x 35w HIT-CE	2040255	4.80kg
2 x 2 x 35w HIT-CE	2038935	4.80kg
<hr/>		
1 x 70w HIT-CE	2038936	1.20kg
2 x 70w HIT-CE	2038937	2.40kg
3 x 70w HIT-CE	2038938	3.60kg
4 x 70w HIT-CE	2038940	4.80kg
2 x 2 x 70w HIT-CE	2040256	4.80kg

Safety lenses order separately

Spot lens	2027238
Medium lens	2033450
Flood lens	2027234
Elongation lens	2027239

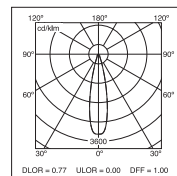
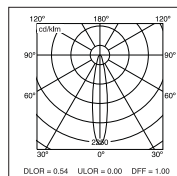
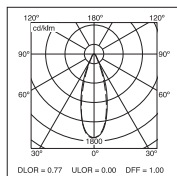
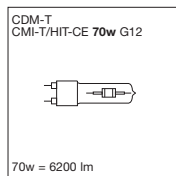
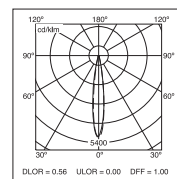
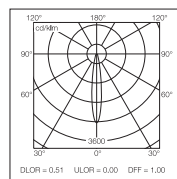
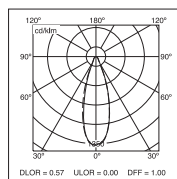
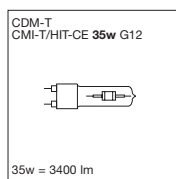

Suspended Lyteframe
See page 167

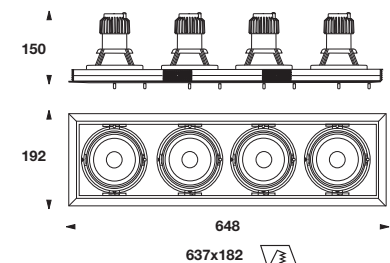
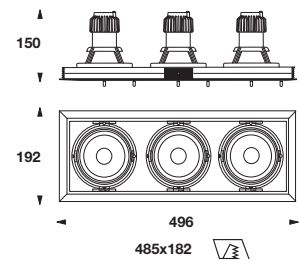
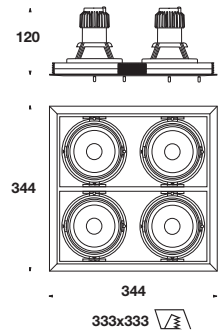
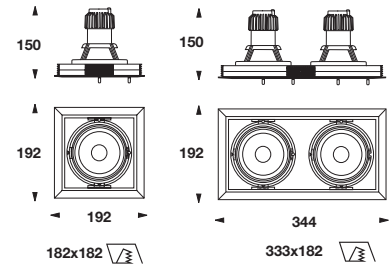



Lytespot

Mains Voltage



Lytespot ES111

Lytespot Mini 63



Lytespot 50



Lytespot 63



Lytespot Universal



- Inspired by Sylvania Hi-Spot PAR type lamps
- Crisp halogen light
- No transformer – low cost installation
- Robust, pressure die-cast aluminium construction
- Dimmable
- Easy installation and maintenance

Mounting: Track: Concord single circuit or three circuit polycarbonate adaptor
Surface: Polycarbonate Monopoint

Housing: Die-cast aluminium smooth polyester powder coated
white RAL 9016 or silver RAL 9006
Lytespot Universal: Silicone rubber lamp sleeve

Lytespot 50

Mains Voltage

- Small, neat and unobtrusive all die-cast design
- Crisp halogen light without the need for a transformer
- No backlight, lamp is fully enclosed at rear
- Robust GU10 lamp base for easy lamp replacement
- **Supplied with Hi-Spot ES50 25° lamp**



Lytespot 50 Supplied c/w lamp		White	Silver	
50w QPAR16	Single Circuit	2520366	2520374	0.21kg
50w QPAR16	Three Circuit	2520367	2520375	0.21kg

Monopoint

For the surface mounting of single or three circuit track adaptors onto ceilings or walls

Monopoint	Single Circuit	3020060	3020070	0.10kg
Monopoint	Three Circuit	3020010	3020030	0.20kg

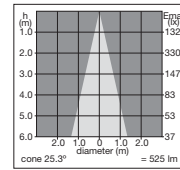
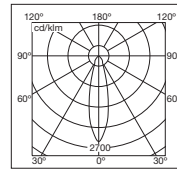

DLOR = 0.87

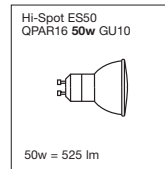

Lytespot Mini 63

Mains Voltage

- Simple, compact all die-cast design
- Robust GU10 lamp base for easy lamp replacement
- Crisp halogen light without the need for a transformer
- **Supplied with Hi-Spot 75w ES63 25° lamp**
(Can also be used with Hi-Spot ES50 lamp)



Lytespot Mini 63 Supplied c/w lamp		White	Silver	
75w QPAR63	Single Circuit	2525940	2525930	0.21kg
75w QPAR63	Three Circuit	2525942	2525932	0.21kg

Monopoint

For the surface mounting of single or three circuit track adaptors onto ceilings or walls

Monopoint	Single Circuit	3020060	3020070	0.10kg
Monopoint	Three Circuit	3020010	3020030	0.20kg

Accessories Order separately

Glare Shield	Reduces peripheral glare	-	2525980	
--------------	--------------------------	---	----------------	--

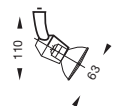
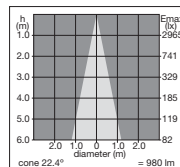
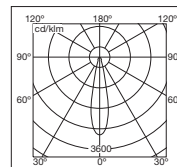

DLOR = 0.71

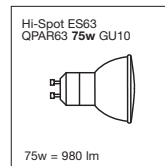

Glare Shield
Accessory

Lytespot 63/80/95

Mains Voltage

- Three sizes and lamp options from 50-100w
- Compact all die-cast design with cowl
- Simple E27 lamp base allows easy lamp replacement
- Crisp halogen light without the need for a transformer
- **Supplied with Hi-Spot QPAR 25° or 30° lamps**



Lytespot 63/80/95 Supplied c/w lamp		White	Silver	
50w QPAR20	Single Circuit	2519445	2519473	0.32kg
50w QPAR20	Three Circuit	2519446	2519474	0.32kg
75w QPAR80	Single Circuit	2519449	2519477	0.37kg
75w QPAR80	Three Circuit	2519450	2519478	0.37kg
100w QPAR30	Single Circuit	2519453	2519481	0.40kg
100w QPAR30	Three Circuit	2519454	2519482	0.40kg

Monopoint

For the surface mounting of single or three circuit track adaptors onto ceilings or walls

Monopoint	Single Circuit	3020060	3020070	0.10kg
Monopoint	Three Circuit	3020010	3020030	0.20kg

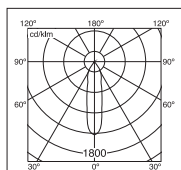

DLOR = 0.49
Lytespot 63

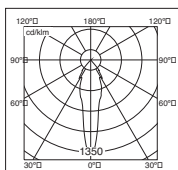
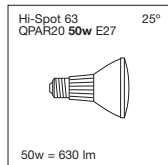
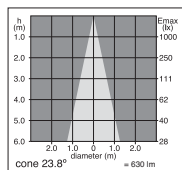

DLOR = 0.57
Lytespot 80

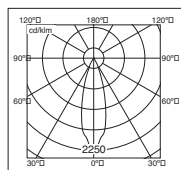
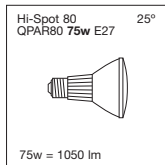
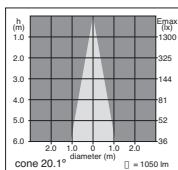

DLOR = 0.65
Lytespot 95

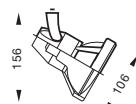
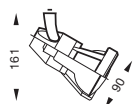
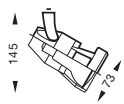
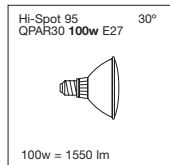
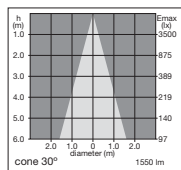

Lytespot 63



Lytespot 80



Lytespot 95



Lytespot Universal

Mains Voltage

- Simple all die-cast design accepts a variety of lamps
- Suitable for use with 75w R80 lamps as well as Hi-Spot 63/80/95
- Must be used with rubber sleeve supplied
- **Order lamp separately**



Lytespot Universal		White	Silver	
50-100w QPAR20/80/ 75w R80	Single Circuit	2520596	2520601	0.18kg
50-100w QPAR20/80/ 75w R80	Three Circuit	2520598	2520603	0.18kg

Monopoint

For the surface mounting of single or three circuit track adaptors onto ceilings or walls
Track Adaptor

Monopoint	Single Circuit	3020060	3020070	0.10kg
Monopoint	Three Circuit	3020010	3020030	0.20kg

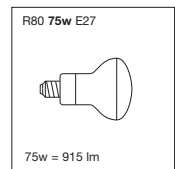
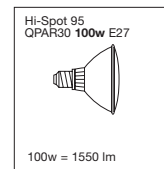
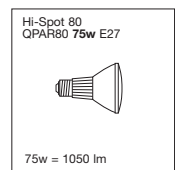
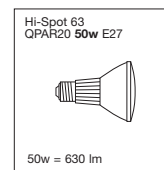
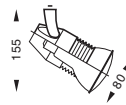

Lytespot ES111

Mains Voltage

- Robust die-cast design
- Crisp halogen light without the need for a transformer
- Integral glare shield and large reflector for clean, low glare beam
- **Supplied with Sylvania 75w 24° Hi-Spot ES111 reflector lamp**

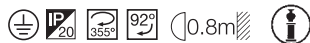

Lytespot ES111 Supplied c/w lamp		White	Silver	
75w QPAR111	Single Circuit	2532796	2532807	0.40kg
75w QPAR111	Three Circuit	2532797	2532808	0.40kg

Monopoint

For the surface mounting of single or three circuit track adaptors onto ceilings or walls

Monopoint	Single Circuit	3020060	3020070	0.10kg
Monopoint	Three Circuit	3020010	3020030	0.20kg

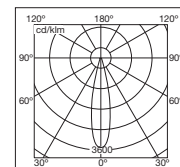
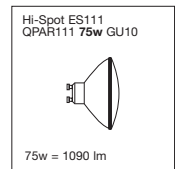
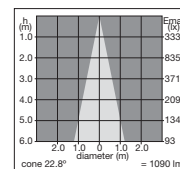

DLOR = 0.76



Torus

Spotlights and Wallwasher



- Low voltage and metal halide spotlights
- Metal halide wallwasher
- Lightweight integral electronic control gear and transformers
- On-board dimmer (Torus 100FX only)
- Lockable head and focusing facility
- Broad range of interchangeable accessories, lenses and filters
- Spotlight effects are easily changed to suit application
- See page 109 for complementary recessed versions

Mounting:	Track:	Concord single circuit or three circuit polycarbonate adaptor
	Surface:	Polycarbonate mounting plate
Gear:		Integral electronic gear with timed ignition and thermal cut-out
Transformer:		Integral electronic transformer with voltage regulation, double average lamp life and thermal cut-out
Housing:		Die-cast aluminium, powder coated smooth white RAL 9016, silver RAL 9006, black RAL 9005
Reflector:		Aluminium
Bezel:		Die-cast aluminium, polycarbonate and silicone
Safety Lens:		Borosilicate glass
Filters:		Glass
Accessories:		Aluminium, steel

Torus Spotlights

	White	Silver	Black	Housing	Lamp Type	Spot Lens	Low Glare Spot Lens	Medium Spot Lens	Flood Lens	Wide Flood Lens	
Torus 50 Low Voltage											
Single Circuit	2025729	2025734	2025739			12v QTax 50w GU5.3					
Three Circuit	2025730	2025735									
Torus 50FX Low Voltage											
10° Spot											
Single Circuit	2028550	2028555	2028560			12v QTax 50w GY6.35	2030818				
Three Circuit	2028551	2028556	2028561								
25° Flood											
Single Circuit	2028565	2028570	2028575					2030822			
Three Circuit	2028566	2028571	2028576					2030821			
Torus 100W AR111 Low Voltage											
Single Circuit	2037270					AR111 100w GX10					
Torus 100FX Low Voltage											
8-14° Low Glare (c/w 100w Lamp)											
Single Circuit	2031890	2031894	2031898			12v QTax 100w GY6.35	2027238				
Three Circuit	2031891	2031895	2031900								
8-12° Spot (c/w 100w Lamp)											
Single Circuit	2031863	2031867	2031872				2031577				
Three Circuit	2031864	2031868	2031873								
34° Flood (c/w 100w Lamp)											
Single Circuit	2031876	2031881	2031885					2027234			
Three Circuit	2031877	2031882	2031886					2032480			
Torus BriteSpot 50											
(c/w 50w 24° Lamp)						BriteSpot ES50 35w GX10					
Single Circuit	2034990	2034994									
Three Circuit	2034991										
Torus BrightSpot 111											
(c/w 35w 38° Lamp)						BriteSpot ES111 35w GX10					
Single Circuit	2037413										
Three Circuit	2037417										
Torus 35FX CMI/CDM-TC											
10° Spot											
Single Circuit	2021835	2031840				CMI-TC/CDM-TC/CMH-TC 35w G8.5	2027238				
Three Circuit	2031836	2031841	2031845								
37° Flood											
Single Circuit	2031848	2031853	2031857					2027234			
Three Circuit	2031850	2031854	2031858					2032480			
Torus 35 FX CMI/CDM-T											
11° Spot											
Single Circuit	2035032	2035035	2035038			CMI-T/CDM-T/CMH-T 35w G12	2027238				
Three Circuit	2035033	2035036									
28° Flood											
Single Circuit	2035042	2035045	2035048					2027234			
Three Circuit	2035043	2035046	2035050								
Torus 70FX CMI/CDM-TC											
11° Spot											
Single Circuit	2029058	2029063				CMI-TC/CDM-TC/CMH-TC 70w G8.5	2027238				
Three Circuit	2029059	2029064									
39° Flood											
Single Circuit	2029073	2029078						2027234			
Three Circuit	2029074	2029079						2032480			
Torus 70 FX CDM-T											
12° Spot											
Single Circuit	2036370	2036373				CMI-T/CDM-T/CMH-T 70w G12	2027238				
Three Circuit	2036371	2036374	2036377								
29° Flood											
Single Circuit	2036380	2036383	2036386					2027234			
Three Circuit	2036381	2036384	2036387								

Torus Spotlights



Narrow Reflector

Wide Reflector

UV Filter

Daylight Filter

Flesh Tone Filter

Coloured Filter
Blue/Amber/Red

Honeycomb Filter

Glare Shield

Barn Door

Iris Arm

Framing Arm
(Must be used
with 25" Spot)

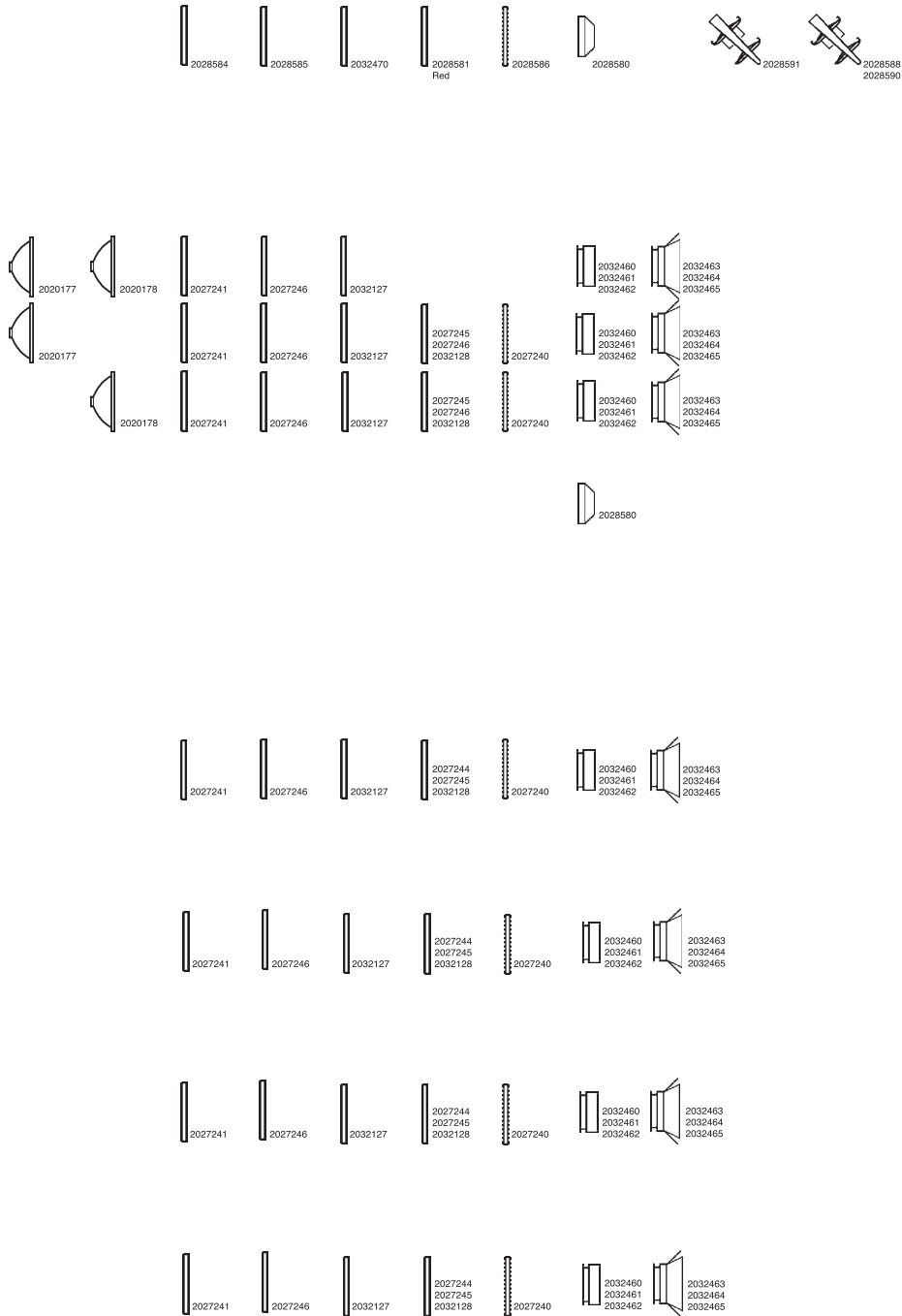

Torus 50

Low Voltage

- Ultra slim compact electronic spotlight – 150mm depth
- 20-50w dichroic lamps
- Integral electronic transformer doubles average lamp life
- Collectively dimmable using trailing and leading edge dimming systems
- Head design enables quick re-lamping
- Aluminium lamps such as Sylvania Coolfit can significantly reduce backlight
- Cool-to-touch polymer adjuster



10° Spot/38° Flood

		White	Silver	Black	
50w QR-CBC51	Single Circuit	2025729	2025734	2025739	0.30kg
50w QR-CBC51	Three Circuit	2025730	2025735	-	0.30kg

Monopoint

For the surface mounting of single or three circuit track adaptors onto ceilings or walls

Monopoint	Single Circuit	3020060	3020070	0.10kg
Monopoint	Three Circuit	3020010	3020030	0.20kg

50w 10° Spot

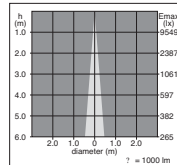

50w 38° Flood

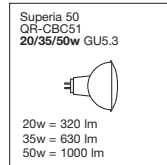
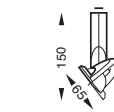
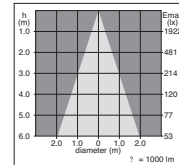

Torus 50FX

Low Voltage

- Versatile super-slim lightweight spotlight
- 20-50w low voltage tungsten halogen capsule lamps
- Integral electronic transformer doubles average lamp life
- Collectively dimmable using trailing and leading edge dimming systems
- Lamp focusing facility and lockable head
- Wide range of screw-fit filters and accessories to customise displays or accent interiors. See page 174
- Interchangeable lens assemblies provide beam options from 10°–42° plus elongation
- Order lamp separately



10° Spot

		White	Silver	Black	
50w QT12-LPax	Single Circuit	2028550	2028555	2028560	0.50kg
50w QT12-LPax	Three Circuit	2028551	2028556	2028561	0.50kg

25° Flood

50w QT12-LPax	Single Circuit	2028565	2028570	2028575	0.50kg
50w QT12-LPax	Three Circuit	2028566	2028571	2028576	0.50kg

25° Flood easily converts to mini-projector. See page 143

Monopoint

For the surface mounting of single or three circuit track adaptors onto ceilings or walls

Monopoint	Single Circuit	3020060	3020070	0.10kg
Monopoint	Three Circuit	3020010	3020030	0.20kg



10° Spot

25° Flood

50w 10° Spot

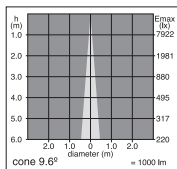

50w 25° Flood

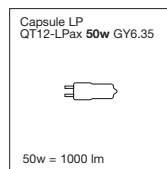
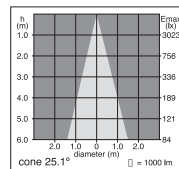

Recessed 50FX also available. See page 111

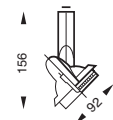

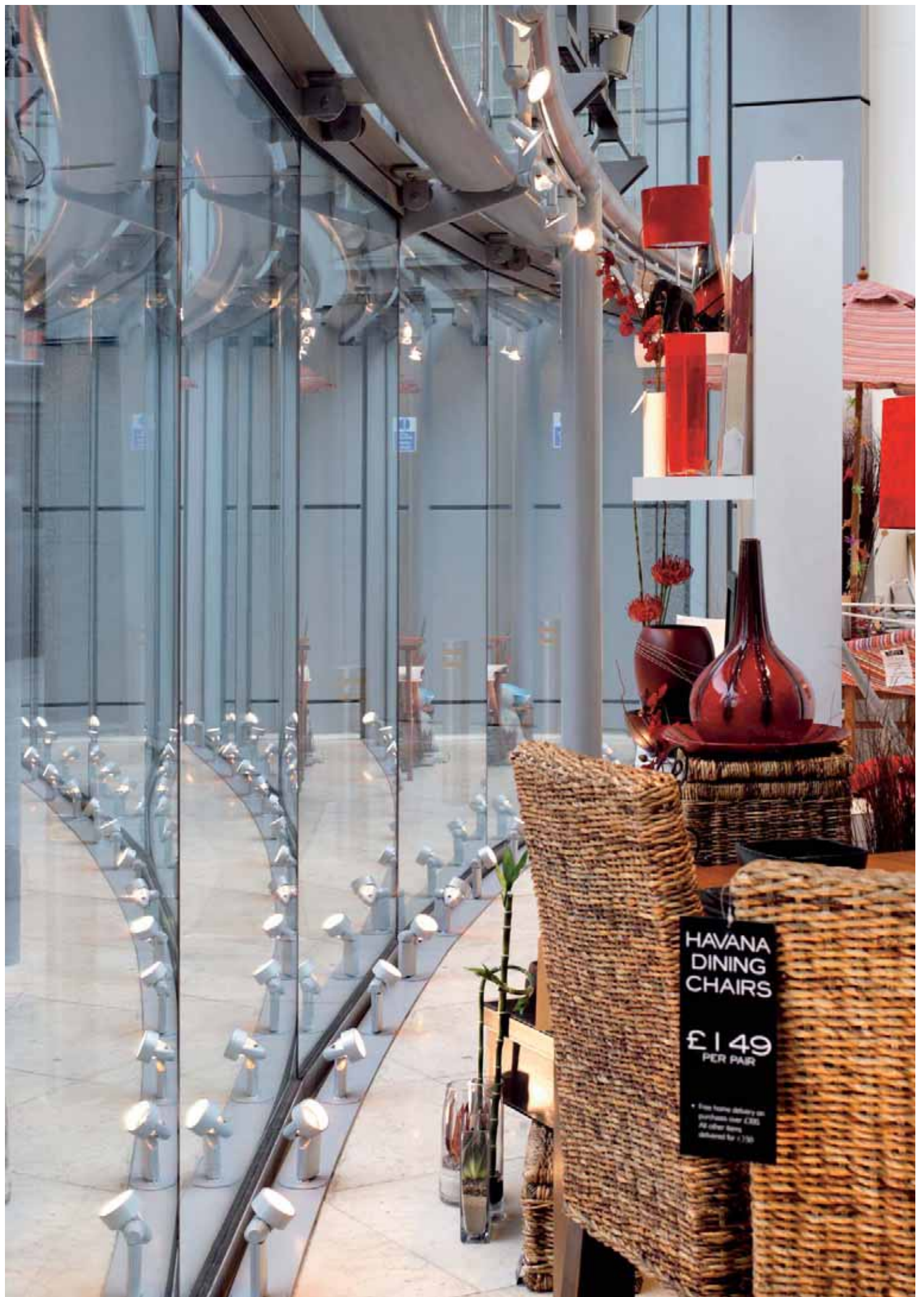

HAVANA
DINING
CHAIRS

£149
PER PAIR

• Free home delivery on
purchases over £300
All other items
subject to £170

Torus 50FX

Accessories



Coloured filters simply **screw-fit** onto front bezel



Optional **snap-fit** glare shield



Bezel easily removed to allow quick lamp replacement or accessories to be fitted

- Twist lock lens assemblies consisting of reflector and front safety lens provide beams from 10° to 42° and elongation
- Screw fit filters
- Snap fit shield accessory



Optional Lens Assemblies

Spot	10°	2030818
Flood	25°	2030822
Wide Flood	42°	2030821
Elongation	3:1	2030820

Honeycomb



Daylight Correction



UV



Red

Optional Filters

Honeycomb	Not to be used in combination with colour filters	2028586
UV	100% UVB/C and 70% UVA protection	2028584
Red		2028581
Daylight	Converts 3000k to 6000k	2028585

Other colours on request. Up to 2 filters can be stacked (Honeycomb must be at the front).
100% UVA, B and C filter available on request.

Glare Shield



Optional Accessory

Glare Shield	Reduction of peripheral glare	2028580
--------------	-------------------------------	----------------

Black

Torus 50FX

Projector Arm Accessories

- Projector arm consisting of pin, cowl and arm
- Four framing plates adjust to provide projection of any four sided shape
- Iris plates in three different sizes
- Hard or soft focusing from adjustment at front or arm
- For use with 25° flood lens assembly



Optional projector arm for framing or irises

Projection Sizes and Output

Head	Distance	Narrow Iris	Medium Iris	Wide Iris	Lux/Klm
Iris (Øm)	1m	0.15	0.25	0.39	1500
	2m	0.32	0.55	0.82	315
	3m	0.48	0.80	1.28	140

Head	Distance	max	min	Lux/Klm
Framing (m²)	1m	0.17	0.03	1500
	2m	0.34	0.05	315
	3m	0.66	0.10	140



Precise projector lens focusing facility

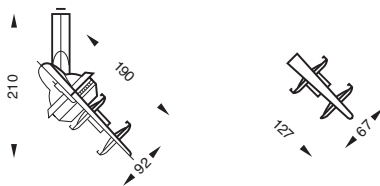

Projector Accessory Arms

Projector arm accessories converts 25° Flood to Mini-Projector

	White	Black	
Framing Accessory Arm	2028588	2028590	0.20kg
Iris Accessory Arm	2028591	-	0.20kg

Iris Accessory Arm comes complete with 3 different sized Irises



Easily adjustable framing head



Framing

Iris



Interchangeable irises in three sizes

Torus 100FX

Low Voltage

- New – Smaller gearbox
- Extremely light and super-compact spotlight
- 50-100w tungsten halogen axial filament capsule lamp
- Integral electronic transformer doubles average lamp life
- Individually dimmable using on-board dimmer
- Collectively dimmable using trailing and leading edge dimming system
- Lamp focusing facility
- Lockable in both pan and tilt orientation
- Wide range of filters and accessories to customise displays or accent interiors
- Interchangeable safety lens and reflectors provide beam options from 6°–60° plus elongation
- **Supplied with Sylvania 100w axial filament lamp**
- **Previous version still available on request**



8-12° Spot		White	Silver	Black	
100w QT12-LPax	Single Circuit	2040754	2040755	2040756	0.00kg
100w QT12-LPax	Three Circuit	2040757	2040758	2040759	0.00kg

8-14° Low Glare Spot					
100w QT12-LPax	Single Circuit	2040760	2040761	2040762	0.00kg
100w QT12-LPax	Three Circuit	2040763	2040764	2040765	0.00kg

NOTE: Not to be used in combination with Honeycomb or Coloured Filter

34° Flood					
100w QT12-LPax	Single Circuit	2040766	2040767	2040768	0.00kg
100w QT12-LPax	Three Circuit	2040769	2040770	2040771	0.00kg



Low Glare Spot

Flood

Monopoint

For the surface mounting of single or three circuit track adaptors onto ceilings or walls

Single Circuit	3020060	3020070	0.10kg
Three Circuit	3020010	3020030	0.20kg

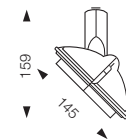

- 8° Spot
- 12° Spot
- 8° Low Glare Spot
- 14° Low Glare Spot
- 34° Flood

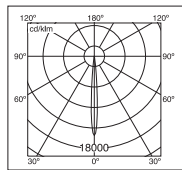

DLOR = 0.69

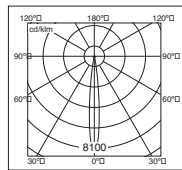

DLOR = 0.67

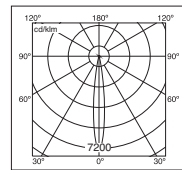

DLOR = 0.52

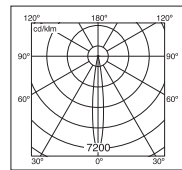

DLOR = 0.52

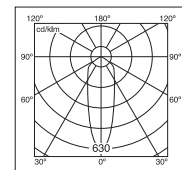

DLOR = 0.54

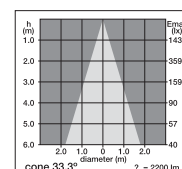
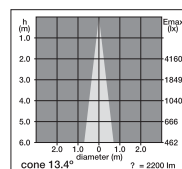
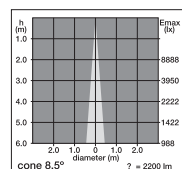
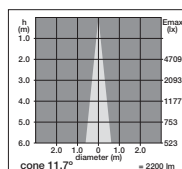
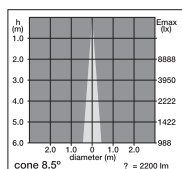
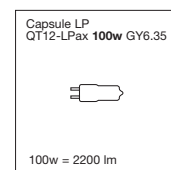

On-board dimmer

Recessed Torus 100FX
See page 114



Torus 100FX

Accessories

- Interchangeable safety lenses, wattages and 100FX reflectors provide beam options from 6-60°
- Elongation safety lens for highlighting sculptures, mannequins, logos and shelving
- Coloured filters for creating dramatic effects and highlighting displays
- Honeycomb filter, screw-fit glare shield and barn door accessories for effective glare control
- A combination of accessories can be fitted but must always include a safety lens next to the lamp



As with Torus spotlights, interchangeable control lenses and filters simply **push-fit** into new die-cast holder design



Optional barn door, glare shield and gel filter holder easily **screw-fit** onto front of holder



Bezel easily removed to allow quick lamp replacement or accessories to be fitted



Optional elongation lens rotates in any axis whilst in operation

Interchangeable Safety Lenses and Reflectors

	100w QT-ax	Wide Reflector 2020178	Narrow Reflector 2020177	
Spot Lens	8-12°	–	6°	2027238
Low Glare Lens	8-14°	24°	6°	2031577
Flood Lens	34°	60°	–	2027234
Medium Lens	24°	–	–	2033450
Wide Flood Lens	58°	–	–	2032480
Elongation Lens	5:1	6:1	4:1	2027239

Optional Filters

Honeycomb	Not to be used in combination with colour filters	2027240
UV	100% UVB/C and 70% UVA protection	2027241
Daylight	Converts 3000k to 6000k	2027246
Flesh Tone	Enhances the appearance of flesh tone, vegetables and meat	2032127
Mid Blue		2032128
Red		2027244
Amber		2027245

Other colours on request. Up to 2 filters can be fitted into the accessory holder in addition to the Safety Lens (Honeycomb must be fitted at the front of the holder). Low Glare Spot cannot be used with Honeycomb or Coloured Filters. Coloured Filters cannot be used in combination

Optional Accessories

		White	Silver	Black
Glare Shield	Reduction of peripheral glare	2032460	2032462	2032461
Barn Doors	Irregular control of light source	2032463	2032464	2032465

Can be used in combination with other filters

Optional Safety Lenses

Spot 100FX



Low Glare 100FX



Elongation



Medium



Flood

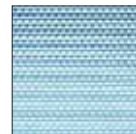

Wide Flood



Reflectors

Narrow Spot



Wide Flood



Optional Filters

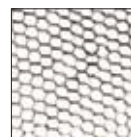

Honeycomb



UV



Daylight Correction



Flesh Tone



Mid Blue



Red



Amber

Optional Accessories



Glare Shield



Barn Doors

Torus AR111

Spotlight

- Extremely light and compact spotlight for 50-100w AR111 low voltage reflector lamps
- Lightweight electronic transformer dimmable with leading or trailing edge dimmers
- On board dimmer reduces individual output down to 20%
- 360° rotation and 90° tilt and lock features
- Discrete front clip secures lamp into front fixture
- Integral glare control from glare cap
- **Order lamp separately**



Torus AR 111	White	
100w QR-LP111 Single Circuit	2037270	0.85kg

Monopoint

For the surface mounting of single or three circuit track adaptors onto ceilings or walls

Single Circuit	3020060	0.10kg
Three Circuit	3020010	0.20kg

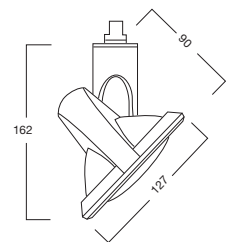

On board dimmer

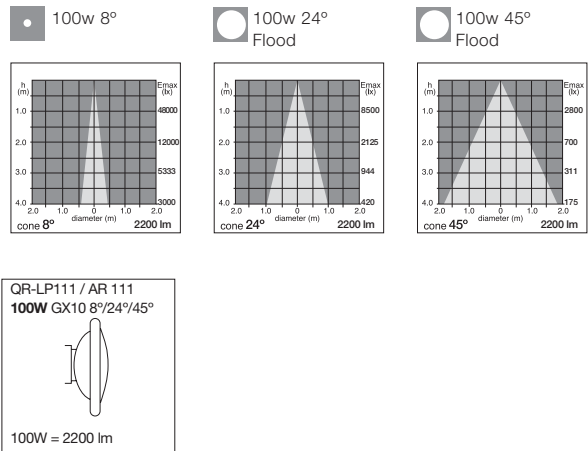

Torus BriteSpot 50

Metal Halide

- High output miniature spotlight
- New BriteSpot ES50 metal halide lamp
- Twice the output of 50w dichroic lamp
- Lockable head
- Crisp, clean 38° beam
- Snap fit cowl accessory for reduction of peripheral glare
- Supplied with lamp grip for ease of lamp replacement
- **Supplied with Sylvania 35w 38° BriteSpot ES50 lamp**



Torus BriteSpot 50	White	Silver	
35w HI-PAR51 Single Circuit	2034990	2034994	0.60kg
35w HI-PAR51 Three Circuit	2034991	-	0.60kg

NOTE: Cannot be mounted on vertical surface or floor

Accessories Order Separately

Black Glare Shield	2028580
--------------------	----------------

Monopoint

For the surface mounting of single or three circuit track adaptors onto ceilings or walls

Single Circuit	3020060	3020070	0.10kg
Three Circuit	3020010	3020030	0.20kg



Shield Accessory

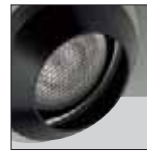

Recessed & Quad Torus BriteSpot 50. See page 110

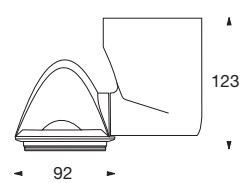
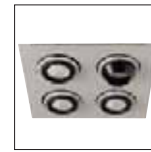

35w 38° Flood

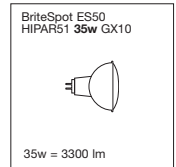
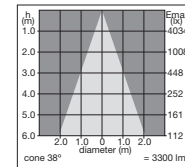
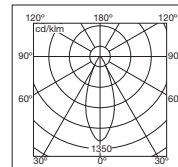

DLOR = 0.64

Torus BriteSpot 111

Spotlight

- Extremely light and compact spotlight for the new metal halide 35W BriteSpot ES111 lamp from Sylvania
- Twice the output of 50w AR111 low voltage reflector lamp
- Lightweight electronic control gear with timed ignition and thermal cut-out
- 360° rotation and 90° tilt and lock features
- Discrete front clip secures lamp into front fixture
- Integral glare control from patented glare cap
- **Supplied with 35w 24° BriteSpot ES111 lamp ***



Torus BriteSpot 111	White	Silver	
35w HI-PAR111 Single Circuit	2037413	-	1.14kg
35w HI-PAR111 Three Circuit	-	2037417	1.14kg

* Offer available for limited period only

Monopoint

For the surface mounting of single or three circuit track adaptors onto ceilings or walls

Single Circuit	3020060	3020070	0.10kg
Three Circuit	3020010	3020030	0.20kg

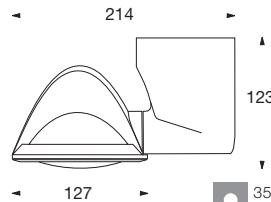

35w 8° Spot

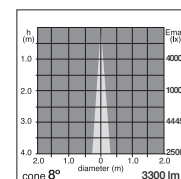
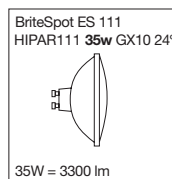

35w 24° Flood

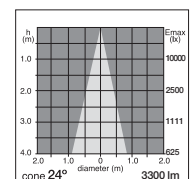

Torus 35/70FX

CMI/CDM-TC

- Extremely light and compact spotlight
- 35/70w CMI/CDM-TC ceramic metal halide capsule lamp
- Lightweight electronic control gear, with timed ignition and thermal cut-out
- Flicker-free operation
- Lamp focusing facility and lockable head
- Wide range of filters and accessories to customise displays or accent interiors. See page 150
- Interchangeable safety lenses provide beam options from 10°–58° plus elongation. See page 150
- **Order lamp separately**



10° Spot		White	Silver	Black	
35w HIT-TC-CE	Single Circuit	2031835	2031840	–	0.85kg
35w HIT-TC-CE	Three Circuit	2031836	2031841	2031845	0.85kg

37° Flood		White	Silver	Black	
35w HIT-TC-CE	Single Circuit	2031848	2031853	2031857	0.85kg
35w HIT-TC-CE	Three Circuit	2031850	2031854	2031858	0.85kg

11° Spot		White	Silver	Black	
70w HIT-TC-CE	Single Circuit	2029058	2029063	–	0.92kg
70w HIT-TC-CE	Three Circuit	2029059	2029064	–	0.92kg

39° Flood		White	Silver	Black	
70w HIT-TC-CE	Single Circuit	2029073	2029078	–	0.92kg
70w HIT-TC-CE	Three Circuit	2029074	2029079	–	0.92kg

Monopoint

For the surface mounting of single or three circuit track adaptors onto ceilings or walls

Single Circuit	3020060	3020070	0.10kg
Three Circuit	3020010	3020030	0.20kg



Recessed Torus 35/70FX
See page 116

35w 10° Spot 35w 37° Flood

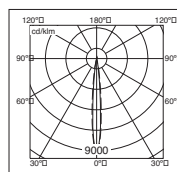

DLOR = 0.37

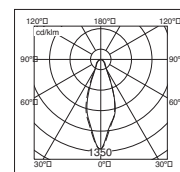

DLOR = 0.68

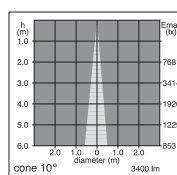
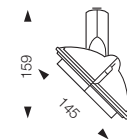

DLOR = 0.69

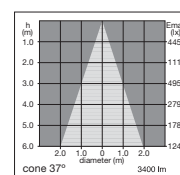

DLOR = 0.67

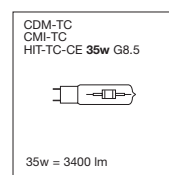

70w 11° Spot 70w 39° Flood

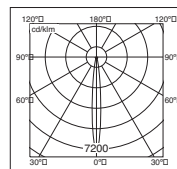

DLOR = 0.69

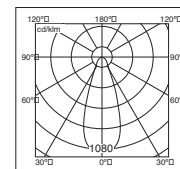

DLOR = 0.67

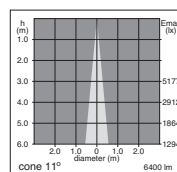
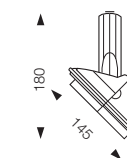

DLOR = 0.69

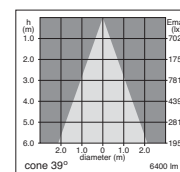

DLOR = 0.67

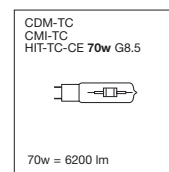

Torus 35/70FX

CMI/CDM-T

- Extremely light and compact spotlight
- 35w and 70w CMI/CDM-T ceramic metal halide capsule lamp
- Well established reliable lamp technology
- Lightweight electronic control gear, with timed ignition and thermal cut-out
- Flicker-free operation
- Lockable head
- Wide range of filters and accessories to customise displays or accent interiors. See page 150
- Interchangeable safety lenses produce spot, flood and elongation beams for optimum display lighting flexibility
- **Order lamp separately**



11° Spot		White	Silver	Black	
35w HIT-CE	Single Circuit	2035032	2035035	2035038	0.90kg
35w HIT-CE	Three Circuit	2035033	2035036	-	0.90kg

28° Flood		White	Silver	Black	
35w HIT-CE	Single Circuit	2035042	2035045	2035048	0.90kg
35w HIT-CE	Three Circuit	2035043	2035046	2035050	0.90kg

12° Spot		White	Silver	Black	
70w HIT-CE	Single Circuit	2036370	2036373	-	0.97kg
70w HIT-CE	Three Circuit	2036371	2036374	2036377	0.97kg

29° Flood		White	Silver	Black	
70w HIT-CE	Single Circuit	2036380	2036383	2036386	0.97kg
70w HIT-CE	Three Circuit	2036381	2036384	2036387	0.97kg

Monopoint

For the surface mounting of single or three circuit track adaptors onto ceilings or walls		White	Silver	Black	
Single Circuit		3020060	3020070		0.10kg
Three Circuit		3020010	3020030		0.20kg



Recessed Torus 35/70FX
See page 116

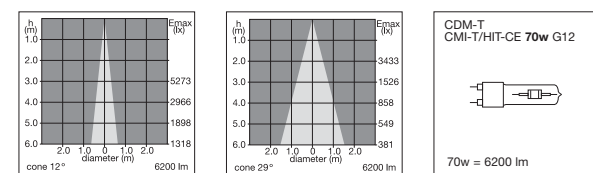
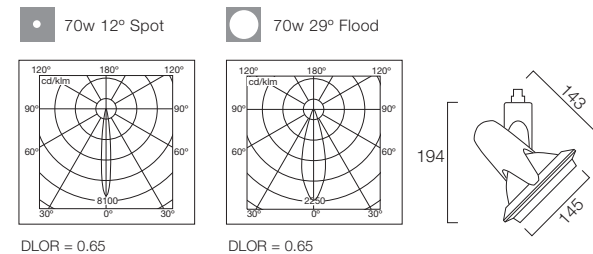
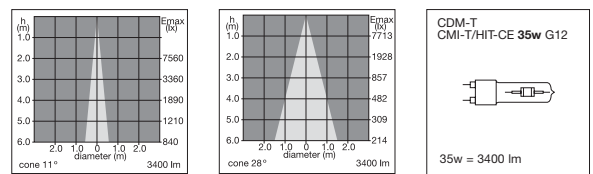
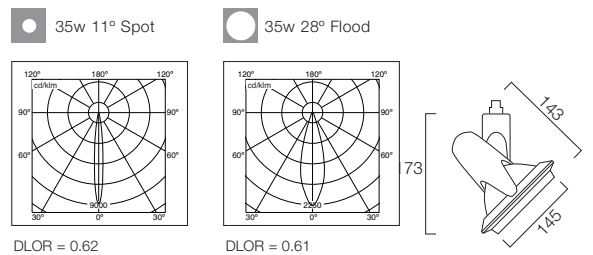

Torus 35/70FX

Accessories

- Interchangeable safety lenses provide beam angles from 10-64°
- Elongation safety lens for highlighting sculptures, mannequins, logos and shelving
- Coloured filters for creating dramatic effects and highlighting displays
- Honeycomb filter, screw-fit glare shield and barn door accessories for effective glare control
- A combination of accessories can be fitted but must always include a safety lens next to the lamp



As with Torus spotlights, interchangeable control lenses and filters simply **push-fit** into new die-cast holder design



Optional barn door, glare shield and gel filter holder easily **screw-fit** onto front of holder



Bezel easily removed to allow quick lamp replacement or accessories to be fitted



Optional elongation lens rotates in any axis whilst in operation

Interchangeable Safety Lenses

	35w	70w	
CMI/CDM-TC	CMI/CDM-TC	CMI/CDM-TC	
Spot Lens	10°	11°	2027238
Flood Lens	37°	39°	2027234
Medium Lens	20°	24°	2033450
Wide Flood Lens	60°	64°	2032480
Elongation Lens	5:1	5:1	2027239

Interchangeable Safety Lenses

	35w	70w	
CMI/CDM-T	CMI/CDM-T	CMI/CDM-T	
Spot Lens	11°	12°	2027238
Flood Lens	28°	29°	2027234
Elongation Lens	5:1	5:1	2027239

Optional Filters

Honeycomb	Not to be used in combination with colour filters	2027240
UV	100% UVB/C and 70% UVA protection	2027241
Daylight	Converts 3000k to 6000k	2027246
Flesh Tone	Enhances the appearance of flesh tone, vegetables and meat	2032127
Mid Blue		2032128
Red		2027244
Amber		2027245

Other colours on request. Up to 2 filters can be fitted into the accessory holder in addition to the Safety Lens (Honeycomb must be fitted at the front of the holder). Low Glare Spot cannot be used with Honeycomb or Coloured Filters. Coloured Filters cannot be used in combination

Optional Accessories

		White	Silver	Black
Glare Shield	Reduction of peripheral glare	2032460	2032462	2032461
Barn Doors	Irregular control of light source	2032463	2032464	2032465

Can be used in combination with other filters.

Optional Safety Lenses

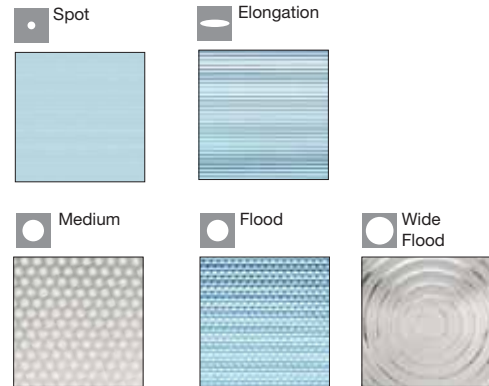

Optional Filters

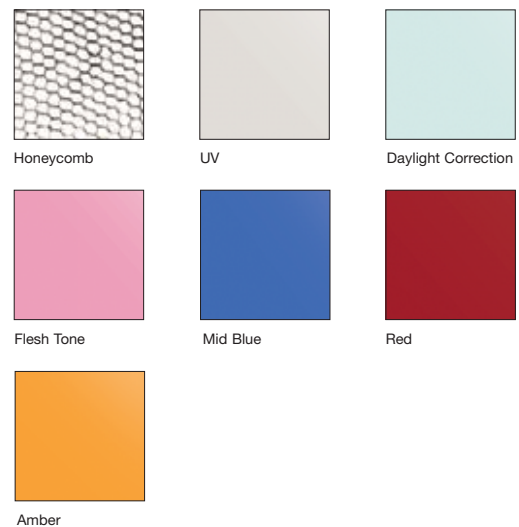

Optional Accessories



Torus 35/70

CM/CDM-T Wallwasher

- High output wallwasher for even illumination of vertical surface
- 35w and 70w CMI/CDM-T ceramic metal halide lamps
- Electronic control gear giving flicker free operation
- Lockable head
- Not suitable for vertical mounting
- Well established reliable lamp technology
- **Order lamp separately**

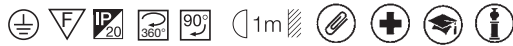

Torus 35w Wallwasher

		White	Silver	
35w HIT-CE	Single Circuit	2034968	2034893	1.20kg
35w HIT-CE	Three Circuit	2034891	2034894	1.20kg
35w HIT-CE	Surface Mounted	2034892	2034895	1.20kg

Torus 70w Wallwasher

70w HIT-CE	Single Circuit	2034896	2034900	1.20kg
70w HIT-CE	Three Circuit	2034897	2034901	1.20kg
70w HIT-CE	Surface Mounted	2034898	2034902	1.20kg

NOTE: Cannot be mounted on vertical surface

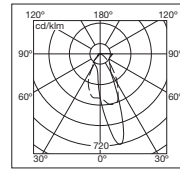

DLOR = 0.55 2034968

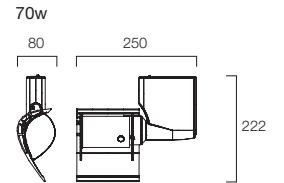
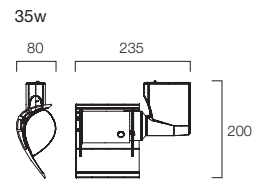
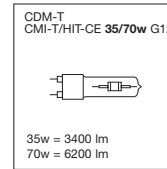

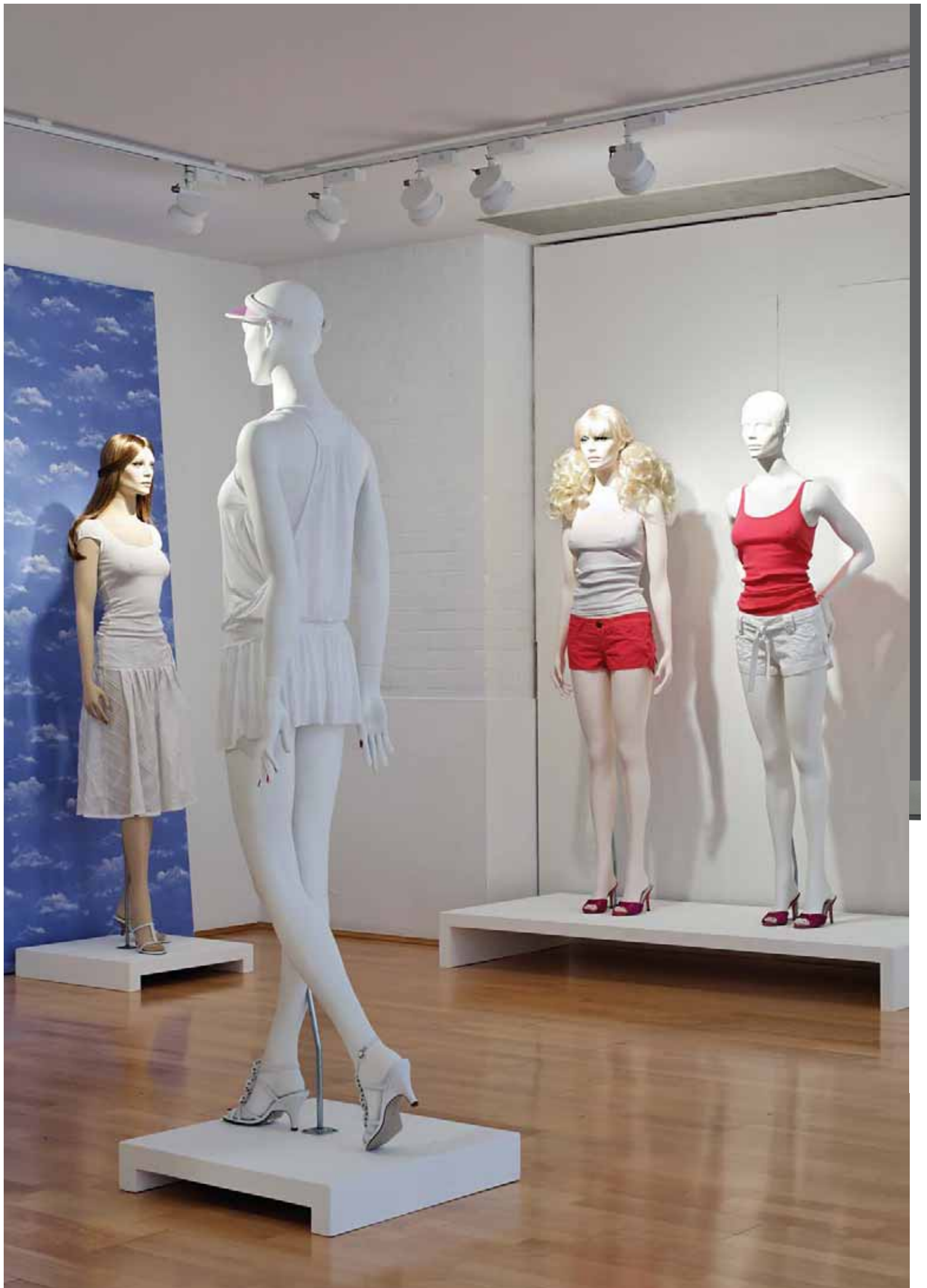

TeQ Collection

TeQ Spot

- Compact spotlight for a broad range of light sources from mains voltage through to metal halide
- Reflector lamps and capsule lamp options with interchangeable lenses, offer a broad array of beams from tight spot through to broad flood
- Accessories offer further light control and creation of colourful effects

TeQ Projector

- Concentrated fully controllable beam of light
- Projection of crisp or soft edge tight spot beams from iris accessory or four sided shapes via framing head
- Gobo option enable projection of logos or symbols

TeQ Linear

- Range of slim linear wallwashers and powerful floods
- Broad, large washes of light evenly from floor to ceiling or over wide display areas



No screw-driver or tools required. All TeQ products feature a tool-less lock rotation and tilt mechanism to allow fixtures to be easily secured in place

TeQ Linear CMI/CDM-T Flood

TeQ Spot CMI/CDM-T



















TeQ Spot QR-111

TeQ Projector QTax







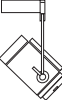

Mounting:	Track:	Concord single or three circuit polycarbonate adaptor
	Surface:	Via LP track accessory
Housing:	Material:	Die-cast aluminium, powder coated finish
	Finish:	White RAL 9016, silver 9006
Reflector:	Materials:	Aluminium
Control Gear:	Transformer:	Integral electronic transformer with voltage regulation, double average lamp life and thermal cut-out
	Dimmable:	Dimmable with leading and trailing edge dimmers
	Ballast:	Integral electronic gear with timed ignition and thermal cut out
Bezel:	Materials:	Die-cast aluminium, inner holder polycarbonate and silicone

TeQ Spot

	White	Silver	Housing	Lamp Type	Accessory Size	Spot Lens	Low Glare Spot Lens	Flood Lens	Wide Flood Lens	Elongation Lens	UV Filter	Daylight Filter
Low Voltage 35-50w QR-CBC51	Single Circuit	2037305	2037307	 12v 35-50w QRC BC51	1				2037461	2037462	2037436	2037437
	Three Circuit	2037306	2037308									
35-100w AR111	Single Circuit	2037318	2037321	 12v 35-100w QR-LP111								
	Three Circuit	2037320	2037322									
12v 35-75w QT-ax	Single Circuit	2037310	2037312	 12v 35-75w QTax	1	2027238 7°	2037457 7°	2037460 30°	2037461 38°	2037462 5:1	2037436	2037437
	Three Circuit	2037311	2037313									
12v 35-100w QT-ax	Single Circuit	2037323	2037325	 12v 35-100w QTax	2	2027238 7°	2031577	2027238 30°	2032480 42°	2027239 5:1	2027241	2027246
	Three Circuit	2037324	2037326									
Metal Halide 35w BriteSpot ES50	Single Circuit	2037292	2037294	 35w Hi-Par 16 (24° supplied)								
	Three Circuit	2037293	2037295									
35w BriteSpot ES111	Single Circuit	2037301	2037303	 35w Hi-Par 36 (24° supplied)								
	Three Circuit	2037302	2037304									
35w CDM-T G12	Single Circuit	2037327	2037330	 35w HIT-CE G12	2	2027238 11°		2027234 28°	2032480 38°	2027239 5:1	2027241	2027246
	Three Circuit	2037328	2037331									
70w CDM-T G12	Single Circuit	2037332	2037334	 70w HIT-CE G12	2	2027238 12°		2027234 28°	2032480 38°	2027239 5:1	2027241	2027246
	Three Circuit	2037333	2037335									
150w CDM-T G12	Single Circuit	2037336	2037338	 150w HIT-CE G12	2	2027238 50°		2027234 28°	2032480 38°	2027239 5:1	2027241	2027246
	Three Circuit	2037337	2037340									

TeQ Projector

	White	Silver	Housing	Lamp Type	Iris Cassettes	Framing Cassettes	Gobo Cassettes	Narrow Lens	Medium Lens	Wide Lens	GEL HOLDER
Low Voltage 35-100w QTax	Single Circuit	2037341	2037343	 12v 35-100w QTax	2037451	2037450	2037452	2037453	2037454	2037455	2037456
	Three Circuit	2037342	2037344								



Flesh Tone Filter	Coloured Filters Blue/Red/Amber	Honeycomb Filter	Glare Shield	Barn Door	Gel Holder
2037438	2037433 2037434 2037435	2037432	2037440 2037441		2037442 2037443
2037438	2037433 2037434 2037435	2037432	2037440 2037441		2037442 2037443
2032127	2032128 2027244 2027245	2027240	2032460 2032462	2032463 2032464	2032466 2032468
2032127	2032128 2027244 2027245	2027240	2032460 2032462	2032463 2032464	2032466 2032468
2032127	2032128 2027244 2027245	2027240	2032460 2032462	2032463 2032464	2032466 2032468

TeQ Linear

	White	Silver	Housing	Lamp Type	UV Filter	louvre	barn doors
Mains Voltage							
200w TH QT-DE					2037444		2037445
Wallwasher							
Single Circuit	2037350	2037352		200w QT-DE			
Three Circuit	2037351	2037353					
Metal Halide					2037444		2037445
35w CDM-T							
Wallwasher				35w HIT-CE			
Single Circuit	2037358	2037361					
Three Circuit	2037360	2037362					
Metal Halide					2037444		2037445
35w CDM-T							
Wallwasher				70w HIT-CE			
Single Circuit	2037358	2037361					
Three Circuit	2037360	2037362					
70w CDM-T					2037444		2037445
Wallwasher				150w HIT-CE			
Single Circuit	2037367	2037370					
Three Circuit	2037368	2037371					
Low Energy						2037447(1200)	
21/39w T5							
Wallwasher				T5			
Single Circuit	2037385	2037387					
Three Circuit	2037386	2037388					
28/54w T5						2037448(900)	
Wallwasher				T5			
Single Circuit	2037390	2037392					
Three Circuit	2037391	2037393					

TeQ Spot - Low Voltage

35 - 50w QR-CBC51

- Compact electronic transformer
- Lockable adaptor and head
- Secure twin fixings to track
- Individually dimmable using on-board dimmer
- Collectively dimmable using trailing and leading edge dimming system
- Wide range of filters and accessories to customise displays or accent interiors
Order size **1** accessories (see page 161)
- **Order lamp separately**



Housing		White	Silver	
50W QR-CBC51	Single Circuit	2037305	2037307	0.90kg
50W QR-CBC51	Three Circuit	2037306	2037308	0.90kg

Surface Mount

For surface mounting of single circuit adaptors order additional surface kit

LP Kit 300mm	Single Circuit	2037464	2037465	0.20kg
--------------	----------------	----------------	----------------	--------

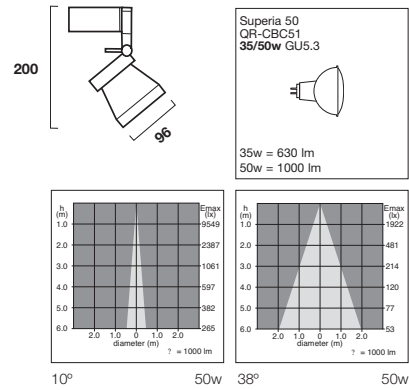

TeQ Spot - Low Voltage

35 - 100w AR111

- Compact electronic transformer
- Lockable adaptor and head
- Secure twin fixings to track
- Individually dimmable using on-board dimmer
- Collectively dimmable using trailing and leading edge dimming system
- Integral glare control in lamp
- **Order lamp separately**



Housing		White	Silver	
100W QR-LP111	Single Circuit	2037318	2037321	1.00kg
100W QR-LP111	Three Circuit	2037320	2037322	1.00kg

Surface Mount

For surface mounting of single circuit adaptors order additional surface kit

LP Kit 300mm	Single Circuit	2037464	2037465	0.20kg
--------------	----------------	----------------	----------------	--------

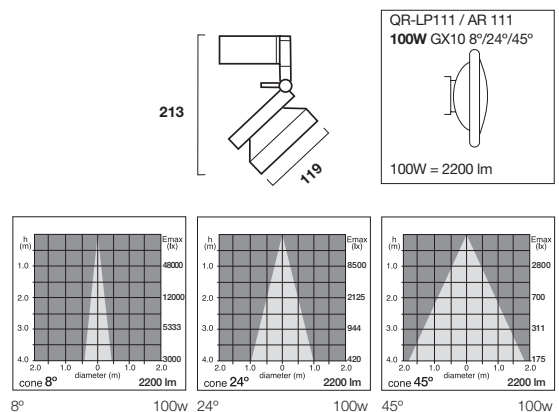

TeQ Spot - Low Voltage

35 - 75w QT-ax

- Compact electronic transformer
- Lockable adaptor and head
- Secure twin fixings to track
- Individually dimmable using on-board dimmer
- Collectively dimmable using trailing and leading edge dimming system
- Wide range of filters and accessories to customise displays or accent interiors - order size **1** accessories (see page 161)
- **Safety lens must be ordered separately**
- **Order lamp separately**



Housing		White	Silver	
75W QT-ax	Single Circuit	2037310	2037312	0.90kg
75W QT-ax	Three Circuit	2037311	2037313	0.90kg

Surface Mount

For surface mounting of single circuit adaptors order additional surface kit

LP Kit 300mm	Single Circuit	2037464	2037465	0.20kg
--------------	----------------	----------------	----------------	--------

Safety Lenses - order in addition to housing

Spot Lens	7°	2037458
Low Glare Lens	7°	2037457
Flood Lens	30°	2037460
Wide Flood Lens	38°	2037461
Elongation Lens	5:1°	2037462

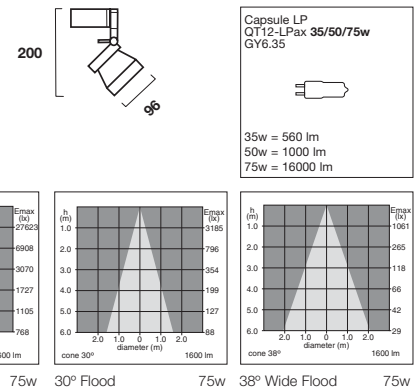

TeQ Spot - Low Voltage

35 - 100w QT-ax

- Compact electronic transformer
- Lockable adaptor and head
- Secure twin fixings to track
- Individually dimmable using on-board dimmer
- Collectively dimmable using trailing and leading edge dimming system
- Wide range of filters and accessories to customise displays or accent interiors - order size **2** accessories (see page 161)
- **Safety lens must be ordered separately**
- **Order lamp separately**



Housing		White	Silver	
100W QT-ax	Single Circuit	2037323	2037325	1.10kg
100W QT-ax	Three Circuit	2037324	2037326	1.10kg

Surface Mount

For surface mounting of single circuit adaptors order additional surface kit

LP Kit 300mm	Single Circuit	2037464	2037465	0.20kg
--------------	----------------	----------------	----------------	--------

Safety Lenses - order in addition to housing

Spot Lens	7°	2027238
Low Glare Lens	7°	2031577
Flood Lens	26°	2027234
Wide Flood Lens	42°	2032480
Elongation Lens	5:1°	2027239

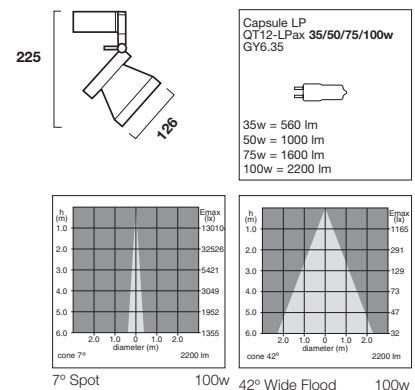

TeQ Spot - Metal Halide

35w BriteSpot ES50

- New Quartz metal halide reflector lamp technology from Sylvania
- Twice the output of 50w Dichroic lamp
- Good colour rendering even at red end of spectrum
- Compact electronic control gear
- Lockable adaptor and head
- Secure twin fixings to track
- Low glare baffle
- **Supplied with 24° degree lamp**
(lamp also available as 38° and 60°)



Housing		White	Silver	
35W HI PAR 51	Single Circuit	2037292	2037294	0.90kg
35W HI PAR 51	Three Circuit	2037293	2037295	0.90kg

Surface Mount

For surface mounting of single circuit adaptors order additional surface kit				
LP Kit 300mm	Single Circuit	2037464	2037465	0.20kg

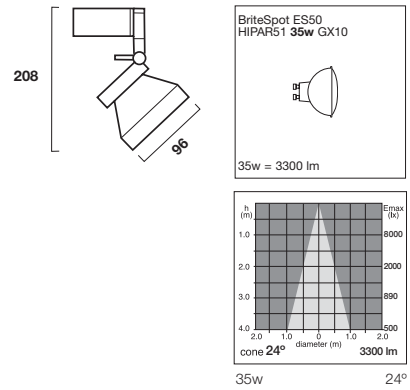

TeQ Spot - Metal Halide

35w BriteSpot ES111

- New Quartz metal halide reflector lamp technology from Sylvania
- Twice the output of 50w AR111 low voltage reflector lamp
- Integral glare control from patented glare cap
- Good colour rendering even at red end of spectrum
- Compact electronic control gear
- Lockable adaptor and head
- Secure twin fixings to track
- **Supplied with 24 degree lamp**
(8 degree lamps also available)



Housing		White	Silver	
35w HI-PAR 111	Single Circuit	2037301	2037303	1.10kg
35w HI-PAR 111	Three Circuit	2037302	2037304	1.10kg

Surface Mount

For surface mounting of single circuit adaptors order additional surface kit				
LP Kit 300mm	Single Circuit	2037464	2037465	0.20kg

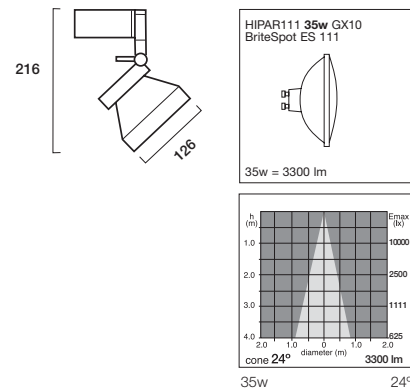

TeQ Spot - Metal Halide

CMI/CDM-T 35w

- Robust G12 based CMI/CDM-T ceramic metal halide capsule lamp
- Electronic control gear
- Lockable adaptor and head
- Secure twin fixings to track
- Wide range of filters and accessories to customise displays or accent interiors - order size **2** accessories (see page 161)
- **Safety lens must be ordered separately**
- **Order lamp separately**



Housing		White	Silver	
35w HIT-CE	Single Circuit	2037327	2037330	1.50kg
35w HIT-CE	Three Circuit	2037328	2037331	1.50kg

Surface Mount

For surface mounting of single circuit adaptors order additional surface kit

LP Kit 300mm	Single Circuit	2037464	2037465	0.20kg
--------------	----------------	----------------	----------------	--------

Safety Lens - order in addition to housing

Spot Lens	11°	2027238
Flood Lens	28°	2027234
Wide Flood Lens	38°	2032480
Elongation Lens	5:1	2027239

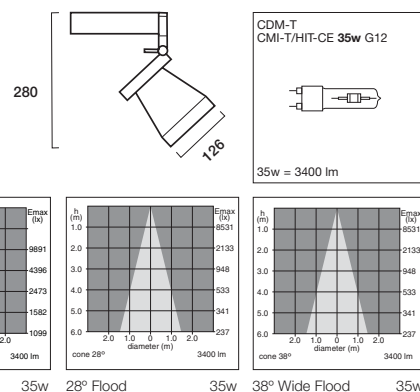

TeQ Spot - Metal Halide

CMI/CDM-T 70w

- Robust G12 based CMI-T ceramic metal halide capsule lamp
- Electronic control gear
- Lockable adaptor and head
- Secure twin fixings to track
- Wide range of filters and accessories to customise displays or accent interiors - order size **2** accessories ((see page 161)
- **Safety lens must be ordered separately**
- **Order lamp separately**



Housing		White	Silver	
70w HIT-CE	Single Circuit	2037332	2037334	1.60kg
70w HIT-CE	Three Circuit	2037333	2037335	1.60kg

Surface Mount

For surface mounting of single circuit adaptors order additional surface kit

LP Kit 300mm	Single Circuit	2037464	2037465	0.20kg
--------------	----------------	----------------	----------------	--------

Safety Lens - order in addition to housing

Spot Lens	12°	2027238
Flood Lens	28°	2027234
Wide Flood Lens	38°	2032480
Elongation Lens	5:1	2027239

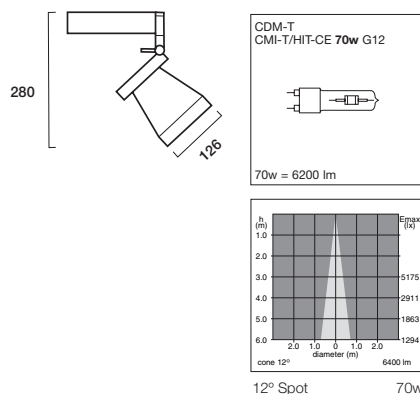

TeQ Spot - Metal Halide

CMI/CDM-T 150w

- Robust G12 based CMI/CDM-T ceramic metal halide capsule lamp
- Electronic control gear
- Lockable adaptor and head
- Secure twin fixings to track
- Wide range of filters and accessories to customise displays or accent interiors - order size **2** accessories (see page 161)
- **Safety lens must be ordered separately**
- **Order lamp separately**

Housing		White	Silver	
150w HIT-CE	Single Circuit	2037336	2037338	1.80kg
150w HIT-CE	Three Circuit	2037337	2037340	1.80kg

Surface Mount For surface mounting of single circuit adaptors order additional surface kit

LP Kit 300mm	Single Circuit	2037464	2037465	0.20kg
--------------	----------------	----------------	----------------	--------

Safety Lens - order in addition to housing

Spot Lens	15°	2027238
Flood Lens	36°	2027234
Wide Flood Lens	45°	2032480
Elongation Lens	5:1	2027239

280

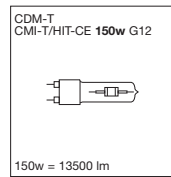
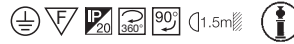
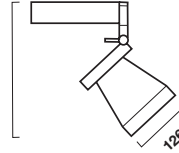

150w = 13500 lm

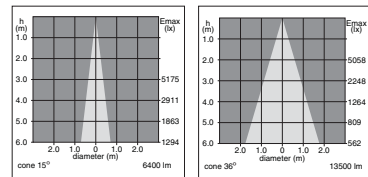

15° Spot 150w 36° Flood 150w

TeQ Projector - Low Voltage

35 - 100w QT-ax

- Ultra compact design
- Fully lockable in all directions
- Secure twin fixings to track
- Individually dimmable using on-board dimmer
- Collectively dimmable using trailing and leading edge dimming system
- Range of lenses and choice of Iris, Framing or Gobo cassette to achieve desired affect - **order separately**
- Optional gel holder for coloured or UV filters
- Lamp can be changed without disturbing projector settings
- **Order lamp separately**



Housing		White	Silver	
100w QT-ax	Single Circuit	2037341	2037343	1.80kg
100w QT-ax	Three Circuit	2037342	2037344	1.80kg

Surface Mount For surface mounting of single circuit adaptors order additional surface kit

LP Kit 300mm	Single Circuit	2037464	2037465	0.20kg
--------------	----------------	----------------	----------------	--------

Head Order in addition to housing

Iris Cassette	2037451	0.12kg
Framing Cassette	2037450	0.10kg
Gobo Cassette	2037452	0.07kg

Lens Arms Assembly

Order in addition to housing and head	Black	
Narrow Lens & Arm Assy	2037453	0.40kg
Medium Lens & Arm Assy	2037454	0.40kg
Wide Lens & Arm Assy	2037455	0.70kg

Optional accessory

Gel Filter - holds coloured or UV gel filters 84-133mmø	2037456	0.10kg
---	----------------	--------

max.
405

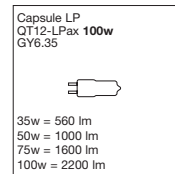
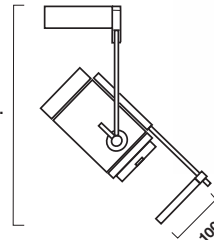

35w = 560 lm
50w = 1000 lm
75w = 1600 lm
100w = 2200 lm

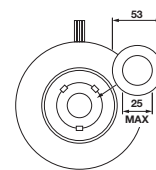

Stainless steel Gobos are available to special order from makers such as Roscolab Limited.

Rosco reference: 'D' type 0.10mm (0.004") stainless steel.

Head	Distance	Narrow Lens *			Medium Lens *			Wide Lens *		
		Max (m)	Min (m)	Lux/Klm	Max (m)	Min (m)	Lux/Klm	Max (m)	Min (m)	Lux/Klm
Iris (Dia. m)	1m	0.33	0.06	10789	0.43	0.06	6790	0.77	0.11	2009
	2m	0.66	0.08	2176	0.99	0.11	1333	1.55	0.19	455
	3m	1.07	0.11	874	1.40	0.18	570	2.32	0.24	202
Framing (m2)	1m	0.25	0.04	10789	0.35	0.05	6790	0.60	0.06	2009
	2m	0.53	0.06	2176	0.69	0.07	1333	1.17	0.12	455
	3m	0.80	0.09	874	1.04	0.11	570	1.74	0.16	202
Gobo (Dia. m)	1m	0.17		10789	0.23		6790	0.40		2009
	2m	0.36		2176	0.48		1333	0.79		455
	3m	0.55		874	0.71		570	1.18		202

* Data given in lux/klm for total lux: (lux/klm x lamp lumens/1000)

Wide variety of colour and UV absorbing gel filters available. Recommended that filters are BS3944 polycarbonate tri-extruded, with a minimum transmission factor of 40%. Available from

TeQ Spot

Accessories

Size **1** or Size **2** accessories

Please refer to product pages or matrix on page 154 for required accessory size



Bezel easily removed to allow quick lamp replacement or accessories to be fitted



Interchangeable control lenses and filters simply **push-fit** into new die-cast holder design

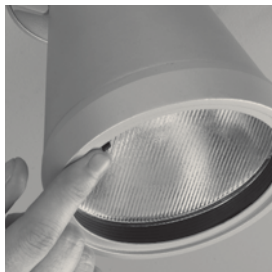

Optional elongation lens rotates in any axis whilst in operation

Safety Lenses

	Size 1	Size 2
Low Glare Spot Lens	2037457	2031577
Spot Lens	2037458	2027238
Flood Lens	2037460	2027234
Wide Flood Lens	2037461	2032480
Elongation Lens	2037462	2027239

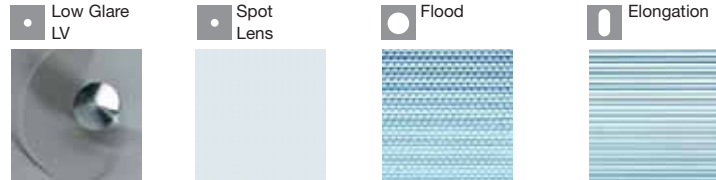

Filters

	Size 1	Size 2
Honeycomb	2037432	2027240
UV	2037436	2027241
Daylight	2037437	2027246
Flesh Tone	2037438	2032127
Mid Blue	2037433	2032128
Red	2037434	2027244
Amber	2037435	2027245

Other colours on request. Up to 2 filters can be fitted into the accessory holder in addition to the Safety Lens (Honeycomb must be fitted at the front of the holder). Low Glare Spot cannot be used with Honeycomb or Coloured Filters. Colour filters cannot be used in combination

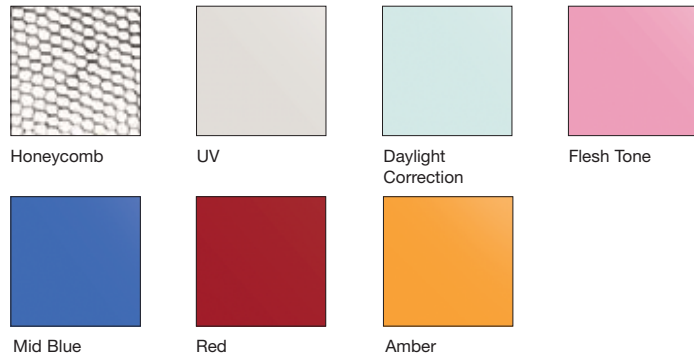

Accessories	Size 1		Size 2	
	White	Silver	White	Silver
Gel Filter Holder	2037442	2037443	-	2032468
Glare Shield	2037440	2037441	2032460	2032462
Barn Doors	-	-	2032463	2032464

Wide variety of colour and UV absorbing gel filters available. Recommended that filters are BS3944 polycarbonate tri-extruded, with a minimum transmission factor of 40%.

Available from makers such as **Roscolab Ltd Tel: +44 (0)20 8659 2300**



Gel Filter Holder

Glare Shield

Barn Doors

TeQ Linear - Mains Voltage

200w TH QT-DE

- Wallwasher
- Tilt lock
- Fitted with borosilicate safety lens
- Easily dimmable
- Optional barn door & UV glass accessories
- **Order lamp separately**



Wallwasher

Wallwasher		White	Silver	
200w QT-DE	Single Circuit	2037350	2037352	0.90kg
200w QT-DE	Three Circuit	2037351	2037353	0.90kg

Surface Mount

For surface mounting of single circuit adaptors order additional monopoint

Monopoint	Single Circuit	2041986	2041987	0.10kg
-----------	----------------	----------------	----------------	--------

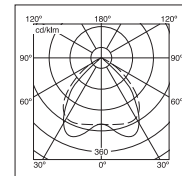
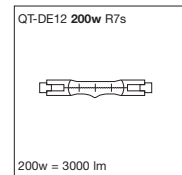
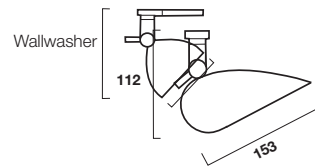

TeQ Linear - Metal Halide

35w CMI/CDM-T

- Wallwasher
- Robust G12 based CMI/CDM-T ceramic metal halide capsule lamp
- Electronic control gear
- Fitted with borosilicate safety lens
- Lockable adaptor and head
- Secure twin fixings to track
- Optional barn door & UV glass accessories
- **Order lamp separately**



Wallwasher

Wallwasher		White	Silver	
35w CDM-T	Single Circuit	2037358	2037361	1.40kg
35w CDM-T	Three Circuit	2037360	2037362	1.40kg

Surface Mount

For surface mounting of single circuit adaptors order additional surface kit

LP Kit 300mm	Single Circuit	2037464	2037465	0.20kg
--------------	----------------	----------------	----------------	--------

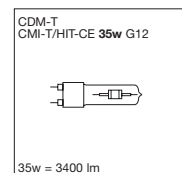
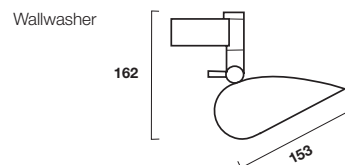

TeQ Linear - Metal Halide

70w CMI/CDM-T

- Wallwasher
- Robust G12 based CMI/CDM-T ceramic metal halide capsule lamp
- Electronic control gear giving flicker free operation
- Lockable adaptor and head
- Fitted with borosilicate safety lens
- Secure twin fixings to track
- Optional barn door & UV glass accessories
- **Order lamp separately**



Wallwasher		White	Silver	
70w CDM-T	Single Circuit	2037367	2037370	1.50kg
70w CDM-T	Three Circuit	2037368	2037371	1.50kg

Surface Mount

For surface mounting of single circuit adaptors order additional surface kit

LP Kit 300mm	Single Circuit	2037464	2037465	0.20kg
--------------	----------------	----------------	----------------	--------



Wallwasher

Wallwasher

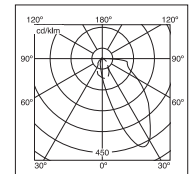
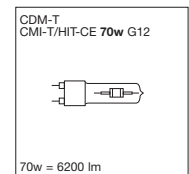
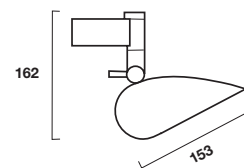

TeQ Linear - Metal Halide

150w CMI/CDM-T

- Wallwasher
- Robust G12 based CMI/CDM-T ceramic metal halide capsule lamp
- Electronic control gear giving flicker free operation
- Lockable adaptor and head
- Fitted with borosilicate safety lens
- Secure twin fixings to track
- Optional barn door & UV glass accessories
- **Order lamp separately**



Wallwasher		White	Silver	
150w CDM-T	Single Circuit	2037376	2037378	1.70kg
150w CDM-T	Three Circuit	2037377	2037380	1.70kg

Surface Mount

For surface mounting of single circuit adaptors order additional surface kit

LP Kit 300mm	Single Circuit	2037464	2037465	0.20kg
--------------	----------------	----------------	----------------	--------



Wallwasher

Wallwasher

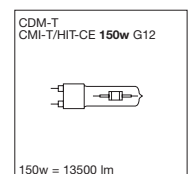
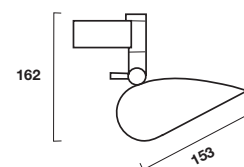

TeQ Linear - Low Energy

21w HE / 39w HO T5

- Asymmetric distribution for wallwashing applications
- Electronic control gear giving flicker free operation
- Will accept 21w High Efficiency or 39w High Output T5 lamps
- Tilttable to ensure light can be accurately cut off at ceiling
- Louvre accessory available
- **Order lamp separately**



Wallwasher

		White	Silver	
21/39w T5	Single Circuit	2037385	2037387	3.50kg
21/39w T5	Three Circuit	2037386	2037388	3.50kg

Surface Mount

For surface mounting of single circuit adaptors order additional surface kit

LP Kit 300mm	Single Circuit	2037464	2037465	0.20kg
LP Kit 650mm	Single Circuit	2037466	2037467	

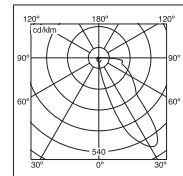
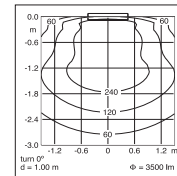
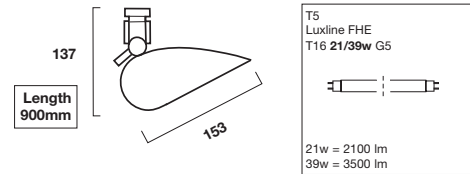

TeQ Linear - Low Energy

28w HE / 54w HO T5

- Asymmetric distribution for wallwashing applications
- Electronic control gear giving flicker free operation
- Will accept 28w High Efficiency or 54w High Output T5 lamps
- Tilttable to ensure light can be accurately cut off at ceiling
- Louvre accessory available
- **Order lamp separately**



Wallwasher

		White	Silver	
28/54w T5	Single Circuit	2037390	2037392	4.30kg
28/54w T5	Three Circuit	2037391	2037393	4.30kg

Surface Mount

For surface mounting of single circuit adaptors order additional surface kit

LP Kit 300mm	Single Circuit	2037464	2037465	0.20kg
LP Kit 650mm	Single Circuit	2037466	2037467	

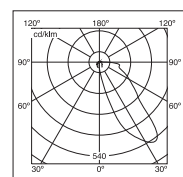
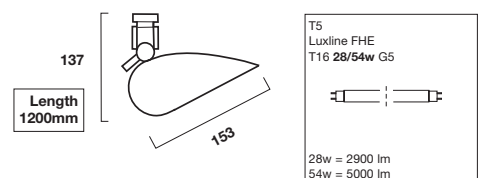

TeQ Linear

Accessories

Mains Voltage and Metal Halide

Accessories

Barn doors - black	2037445
UV filter	2037444



Barn doors

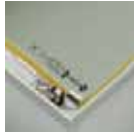

UV glass

Surface Mount Kit

For surface mounting of single circuit adaptors order additional surface kit. Order monopoint for mains voltage

		White	Silver	
LP Kit 300mm	Single Circuit	2037464	2037465	0.20kg

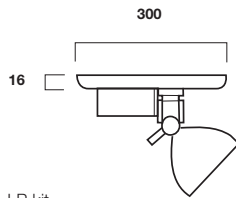

LP kit

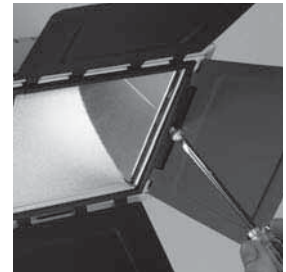

Barn doors screw on to front - screws provided

Low Energy

Accessories

Low Glare Louvre 900mm - silver	2037447
Low Glare Louvre 1200mm - silver	2037448

Please refer to product page or matrix on page 186 for accessory size required



Low Glare Louvre

Surface Mount Kit

For surface mounting of single circuit adaptors order additional surface kit

		White	Silver
LP Kit 300mm	Single Circuit	2037464	2037465
LP Kit 650mm	Single Circuit	2037466	2037467

Please refer to product pages for kit size required

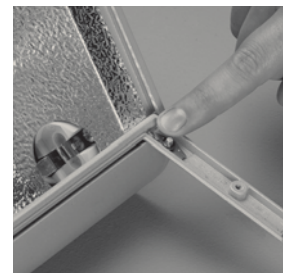
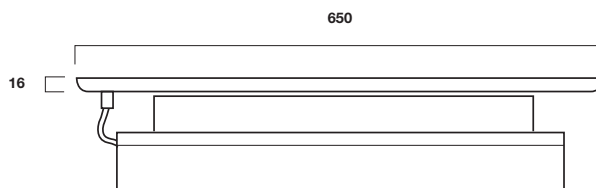

Spring clasps secures UV glass on to front



Lyteframe

Suspended



- Installation flexibility through a choice of twin, triple and quadruple lighting head fixtures available as standard
- Easy installation and onsite configuration by using Concord:marlin adjustable suspension cables and rods, available separately
- High degree of adjustment through cardanic lighting head movement
- Choice of well established, easy to obtain light sources for the end user/lighting designer, including CMI/CDM-T and AR111 sources
- Allows for elimination of independent emergency lighting products with the inclusion of an 3 hour emergency LED module in the suspended 4 way version

Mounting:	Suspended from all ceiling types via wire or rod suspensions
Control Gear:	Integral electronic gear with timed ignition and thermal cut-out
LV Transformer:	Integral electronic transformer with voltage regulation and thermal cut-out
Frame:	Cast/extruded aluminium, powder coated, silver RAL 9006
Gimbal Assembly:	Powder coated die-cast aluminium, black RAL 9005
CMI/CDM-T:	Aluminium reflector Interchangeable borosilicate safety lens (order separately)

Lyteframe

Suspended - Reflector Series

- Built in aluminium reflectors to dissipate heat and light forward
- AR111 dimmable using remote dimming
- Built in anti-glare mechanism
- Easy to install and change the lamps
- For accent and decorative lighting in retail, commercial and domestic applications
- BriteSpot ES111 offers a very high efficiency due to large reflector and patented anti-glare optics
- Integral electronic gear and transformer
- Gimbal adjusts 45° in each direction
- **Order suspensions separately** - see page 171
- **Order lamps separately**



AR111 Low Voltage	Silver	
2 x 100w QR-LP111	2038945	3.10kg
3 x 100w QR-LP111	2038946	4.70kg
4 x 100w QR-LP111	2038947	6.30kg
4 x 100w QR-LP111 with LED Emergency	2038975	7.30kg

BriteSpot ES111/ESD111 Metal Halide		
2 x 35w HI-PAR111	2038948	3.20kg
3 x 35w HI-PAR111	2038950	4.90kg
4 x 35w HI-PAR111	2038951	6.50kg
4 x 35w HI-PAR111 with LED Emergency	2038976	7.30kg
2 x 70w HI-PAR111	2040247	3.20kg
3 x 70w HI-PAR111	2040248	4.90kg
4 x 70w HI-PAR111	2040249	6.50kg
4 x 70w HI-PAR111 with LED Emergency	2040250	7.30kg

CDM-R111 Metal Halide		
2 X 35W CDM-R111	2038958	3.10kg
3 X 35W CDM-R111	2038960	4.70kg
4 X 35W CDM-R111	2038961	6.30kg
4 X 35W CDM-R111 with LED Emergency	2038977	7.30kg

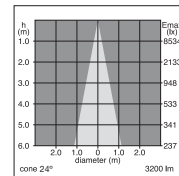
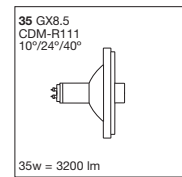
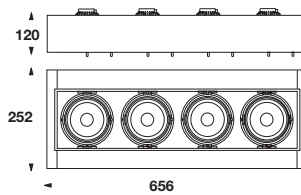
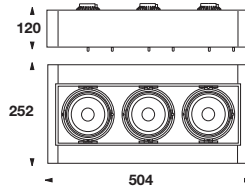
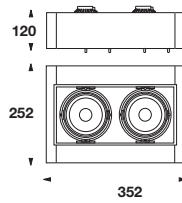

35w CDM-R111 24° lamp

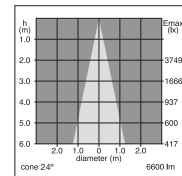

70w CDM-R111 24° lamp

Recessed Lyteframe See page 123



Integral LED Emergency

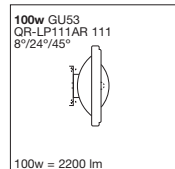

100w = 2200 lm

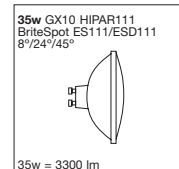

35w = 3300 lm

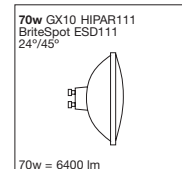

70w = 6400 lm

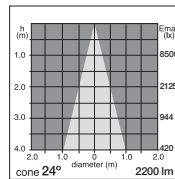

100w QR-LP111 24° lamp

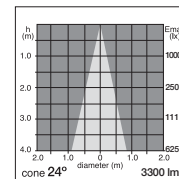

35w HI-PAR 36 24° lamp

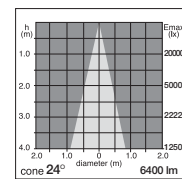

70w HIPAR111 24° lamp

Lyteframe

Suspended - CMI/CDM-T

- Robust G12 based CMI-T ceramic metal halide capsule lamp
- Broad range of beam angle provided by interchangeable safety lenses - **order separately**
- Electronic control gear
- Ceramic arc tube ensures colour uniformity and stability throughout lamp life
- Very high luminous efficiency in a compact lamp format
- Good to excellent colour rendering properties
- Gimbal adjusts 45° in each direction
- **Order suspensions separately** - see page 171
- **Order lamps separately**



CMI/CDM-T	Silver	
2 x 35w HIT-CE	2038952	3.30kg
3 x 35w HIT-CE	2038953	5.00kg
4 x 35w HIT-CE	2038954	6.50kg
4 X 35w HIT-CE with LED Emergency	2038973	7.30kg
<hr/>		
2 x 70w HIT-CE	2038955	3.30kg
3 x 70w HIT-CE	2038956	5.00kg
4 x 70w HIT-CE	2038957	6.50kg
4 x 70w HIT-CE with LED Emergency	2038974	7.30kg

Safety lenses Order separately

Spot lens	2027238
Medium lens	2033450
Flood lens	2027234
Elongation lens	2027239

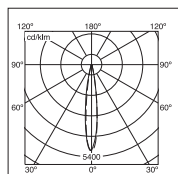
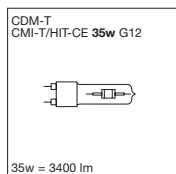
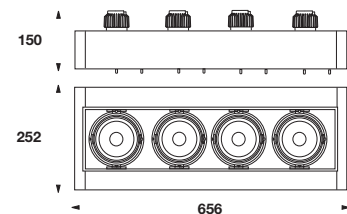
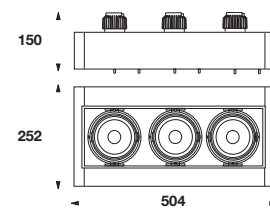
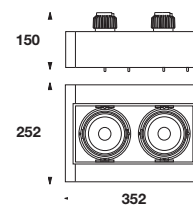

HIT-CE 35w Spot

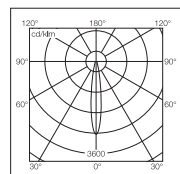

HIT-CE 35w Medium

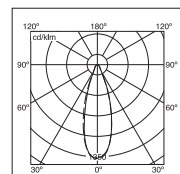

HIT-CE 35w Flood

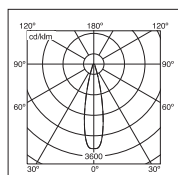
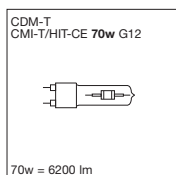

HIT-CE 70w Spot

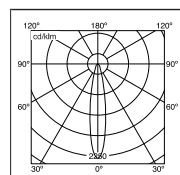

HIT-CE 70w Medium

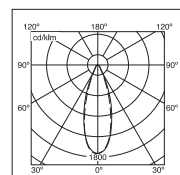

HIT-CE 70w Flood



Recessed Lyteframe See page 123



Integral LED Emergency



Lyteframe

Suspensions

- Rod and Floating suspensions provide rigid fixing up to 1.5m straight down from ceiling. Required for uneven loads or areas exposed to air movement
- Adjustable 3m wire suspensions provide the flexibility to fix from any angle, ideal for sloping ceilings. Longer lengths available as variants
- Clutch adjustment mechanism allows quick and easy installation and levelling. Excess wire can safely be removed
- Twin pivoting suspensions ideal for grids and corners
- Easy to wire mechanical and electrical rod and wire suspensions enable discrete mains supply feeding down to fitting



Single Wire Suspension
(Mech only)

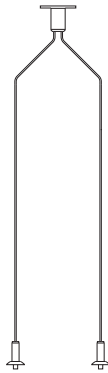

Twin Wire Suspension
(Mech Only)

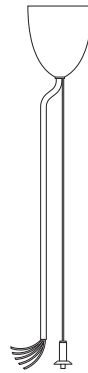

Single Wire Suspension
(Mech/Elec)

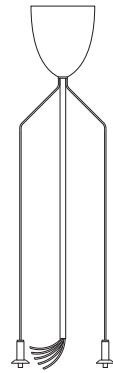

Twin Wire Suspension
(Mech/Elec)



Wire Suspensions

		Length*	Max Load	Mech Only Chrome	Mech Only White	Single Circuit Elec/Mech White	Three Circuit Elec/Mech White
Single Wire Suspension	Length easily adjusted	3.00m	20.00kg	2035031	-	2035014	2035015
Twin Wire Suspension	Length easily adjusted	3.00m	20.00kg	2035016	-	2035017	2035018

Rod Suspensions

Rod Suspension	Can be cut on site from ceiling side only	0.50m		-	2035020	2035021	2035022
	+/- 5mm levelling adjustment	1.00m	25.00kg	-	2035023	2035024	2035025
Rod Extension	Screws onto Mechanical only rod suspensions	0.50m	25.00kg	-	2035026	-	-
	Can NOT be cut on site. Max drop 3.00m						
	+/- 5mm levelling adjustment						
Floating Suspension	+/- 5mm levelling adjustment	0.07m	25.00kg	-	2035027	-	-

*Length refers to distance from mounting surface to back of luminaire

Emergency versions - order three circuit mech/elec suspension

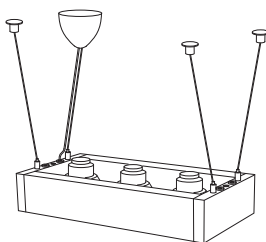

Single wire suspensions

Order: 1 x Mech/Elec
3 x Mech only

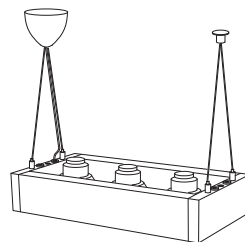

Twin wire suspensions

Order: 1 x Mech/Elec
1 x Mech only

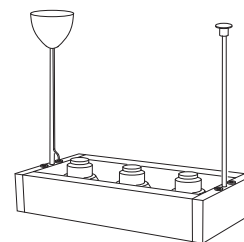

Rod suspensions

Order: 1 x Mech/Elec
1 x Mech only



Single Circuit Track System



- Polarised 16amp single circuit track system with two conductors
- Suitable for use with Concord single circuit adaptor types
- Choice of trunk, low profile or tubular profile to suit application
- Universal feeds and couplers with polarisation determined during installation with polarisation tab
- Unique Push-up feed allows power to be fed on or off anywhere along the length of track
- Can be cut on site
- Broad range of universal suspensions
- Polarised and fully earthed to latest international standards

Construction:	Extruded aluminium profile. PVC liner housing 2 copper conductors
Total Max Load:	240 (230) VAC supply 3840w (3680w) Single fuse rated at 16amps Supply cable 3 x 1.5mm ²
Finish:	Smooth polyester powder paint finish, white RAL 9016, silver RAL 9006 or black RAL 9005

Lytespan 1

Single Circuit Track System

Straight Runs	✓
Bends	✓
Grids	✓
Recessed	✓

- 'Trunk' profile ideal for suspension or surface mount
- Recessed track for suspended ceilings (straight runs only)
- Track kits consisting of starter or joiner tracks with all components needed for single or continuous, surface mounted, straight runs
- Track units and system components enable a scheme to be created to individual requirements
- Broad selection of universal suspensions
- Couplers and other components designed to follow profile of track

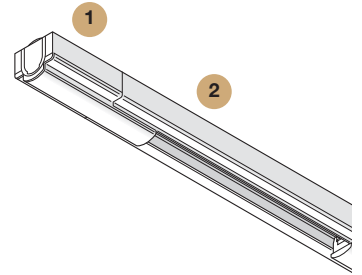

- 1 Plug-in Live Feed
- 2 Track Unit
- 3 T Coupler
- 4 Track Unit
- 5 End Cap
- 6 Rod Suspension (Mechanical only)
- 7 Torus 50 Spotlight
- 8 X Coupler
- 9 Push-up Live Feed
- 10 Single Wire Suspension (Mechanical/Electrical)
- 11 Mounting Clip
- 12 Flexible Coupler
- 13 Torus 50 Spotlight
- 14 Track Unit
- 15 Push-up Live Feed
- 16 Plug-in Coupler
- 17 Pivoting Twin Wire Suspension (Mechanical only)
- 18 L Coupler
- 19 Single Circuit Pendant Adaptor

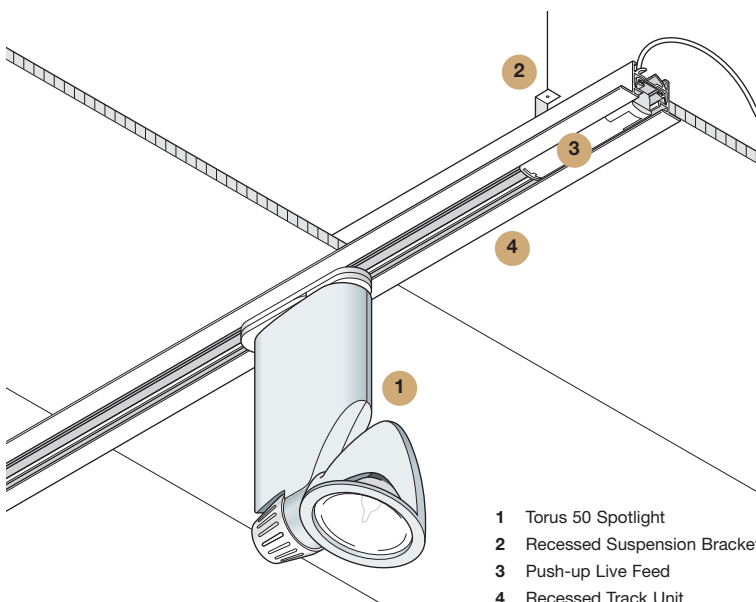

- 1 Torus 50 Spotlight
- 2 Recessed Suspension Bracket
- 3 Push-up Live Feed
- 4 Recessed Track Unit

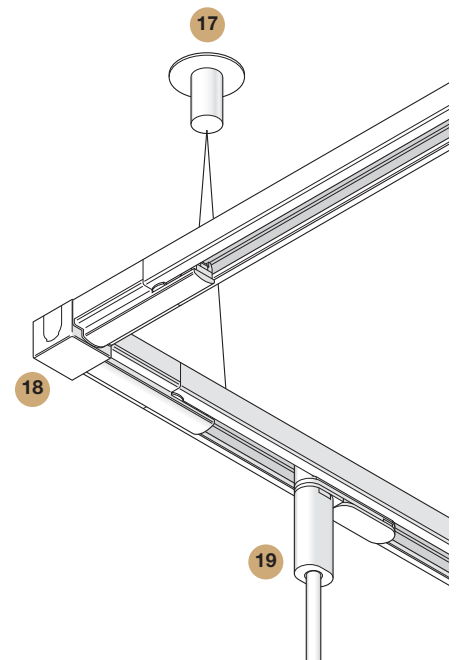

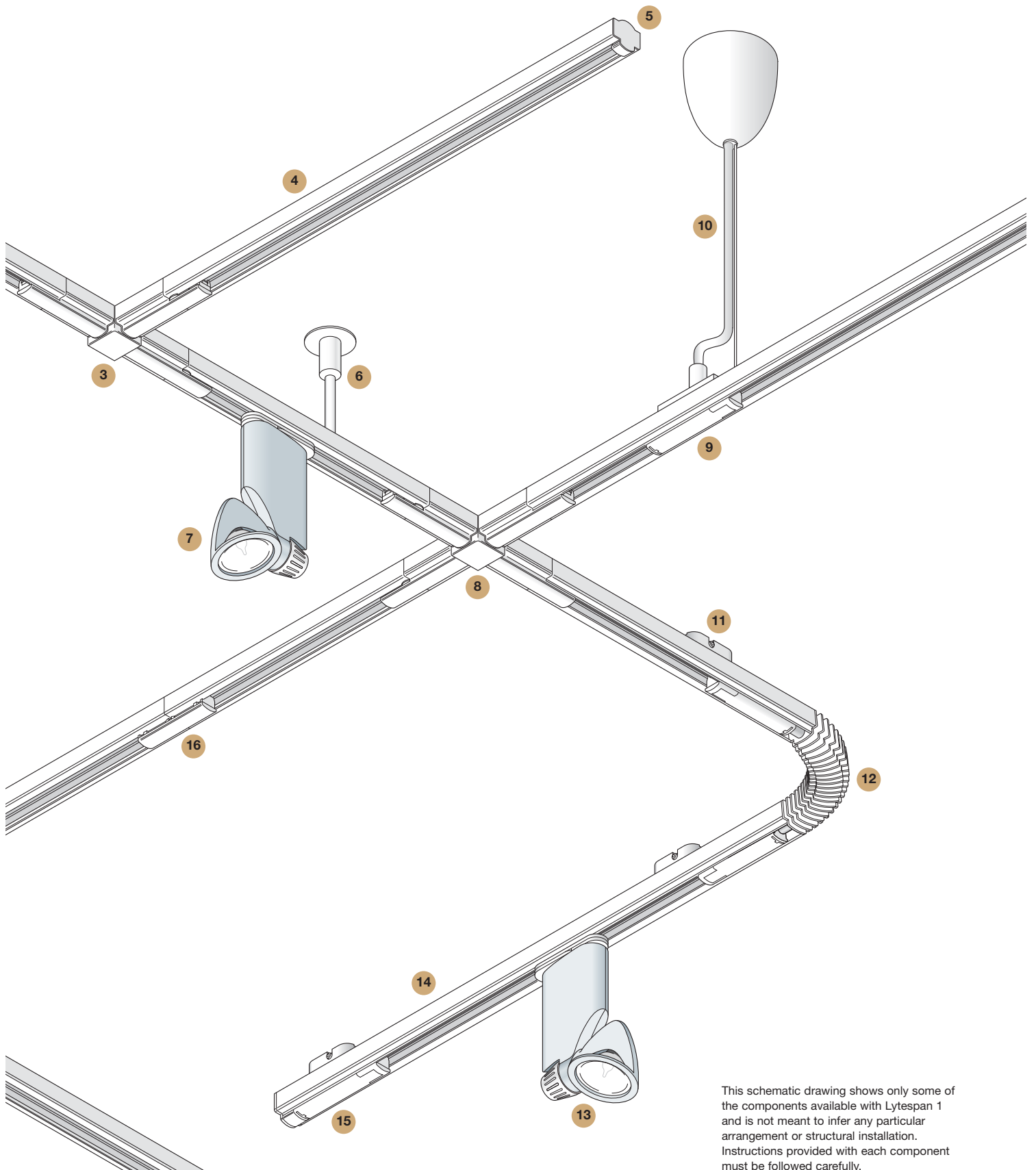

This schematic drawing shows only some of the components available with Lytespan 1 and is not meant to infer any particular arrangement or structural installation. Instructions provided with each component must be followed carefully.

Lytespan 1

Single Circuit Track System

Track Kits

Starter Track Kit

- Ideal for surface mounted runs
- Single length or to start a run
- Supplied with Track Unit, Plug-in Live End, End Caps and Surface Mount Clips



Length	White	
1m	2036010	0.57kg
2m	2036011	1.09kg
3m	2036012	1.61kg

Joiner Track Kit

- Ideal for surface mounted runs
- Extends Starter Track to create straight runs
- Supplied with Track Unit, Plug-in Live Coupler and Surface Mount Clips



Length	White	
2m	2036013	1.06kg
3m	2036014	1.58kg

Track Units and Components

Basic components required for a track scheme:

- | | |
|--|--|
| 1 Track Unit | 4 End Cap: Safely terminates track ends |
| 2 Live Feed: Feeds power onto track | 5 Suspensions: Safely and securely mounts track |
| 3 Coupler: Only required if creating runs | Optional Accessories |

1 Standard Track Unit

- For single or continuous runs, bends and grids
- Ideal for surface mounting or suspension
- Order components and accessories separately

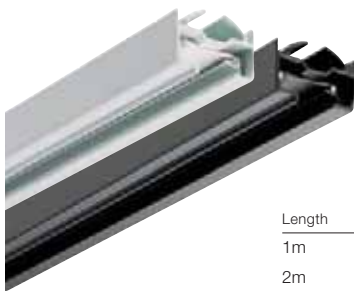

Length	White	Black	
1m	2036015	2036018	0.52kg
2m	2036016	2036020	1.04kg
3m	2036017	2036021	1.56kg

1 Recessed Track Unit

- For single or continuous straight runs
- Ideal for suspended ceilings
- Order components and accessories separately

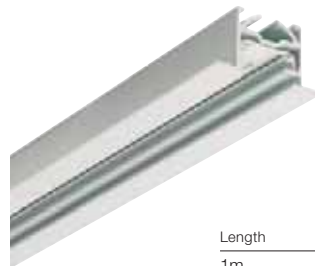

Length	White	
1m	2036022	0.67kg
2m	2036023	1.19kg
3m	2036024	1.71kg

Lytespan 1

Single Circuit Track System

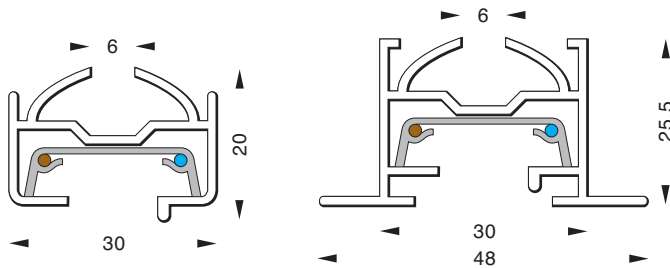
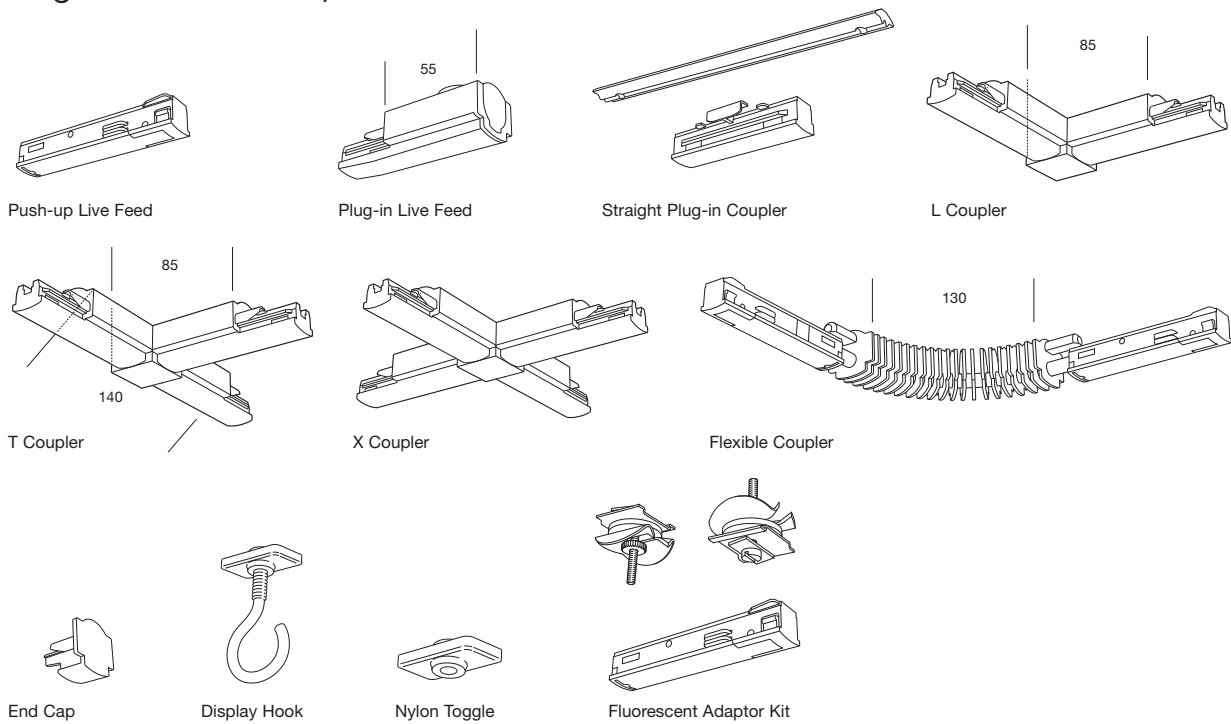

			Standard Track		Recessed Track
			White	Black	White
2 Live Feeds					
Push-up Live Feed	Feeds power on or off anywhere along length of track	Universal	2011305	2011833	2011305
Plug-in Live Feed	Feeds power on or off at end of track	Universal	2011348	2011285	-
3 Couplers					
Straight Plug-in Coupler	Connects tracks mech/elec to create straight runs	Mech/Elec	2011303	2011835	-
L Coupler	Couplers supplied with wires.* Polarisisation determined on site	Mech/Elec	2011379	2011297	-
T Coupler	Couplers supplied with wires.* Polarisisation determined on site	Mech/Elec	2011381	2011299	-
X Coupler	Couplers supplied with wires.* Polarisisation determined on site	Mech/Elec	2011383	2011301	-
Flexible Coupler	Closes to a minimum of 45° horizontally	Mech/Elec	2036027	2036028	-
All couplers can easily be converted to mechanical only couplers.					
* Can be used to feed power on/off of track once internal wires are removed					
4 End Cap					
End Cap	Must be used to safely terminate track ends		2011345	2011283	2011345
5 Suspensions					
Accessories					
Display Hook	Suspends signs, cords etc	Max Load 5.00kg	2007631	-	2007631
Nylon Toggle	M6 thread locks partitions etc into track	Max Load 5.00kg	2007633	-	2007633
Fluorescent Adaptor Kit	For mounting and connecting surface fluorescents onto track	Max 4 amps	2011350	-	2011350

Lytespan LP

Single Circuit Track System

Straight Runs	✓
Bends	✓
Grids	
Recessed	

- Slim, broad based, low profile for surface mounting, onto walls, ceilings or floors
- Track kits consisting of starter or joiner tracks with all the components needed for single or continuous straight runs
- Flexible coupler for bends
- Supplied with screws for surface mounting. Option of concealed method or through fixing using caps and covers supplied
- Couplers and end caps follow elegant profile of track

- 1 Joiner track
- 2 Plug-in coupler
- 3 Screw cap and cover for through fixing
- 4 Flexible Coupler
- 5 Starter track
- 6 End cap
- 7 Push-up live feed
- 8 Torus 50 Spotlight

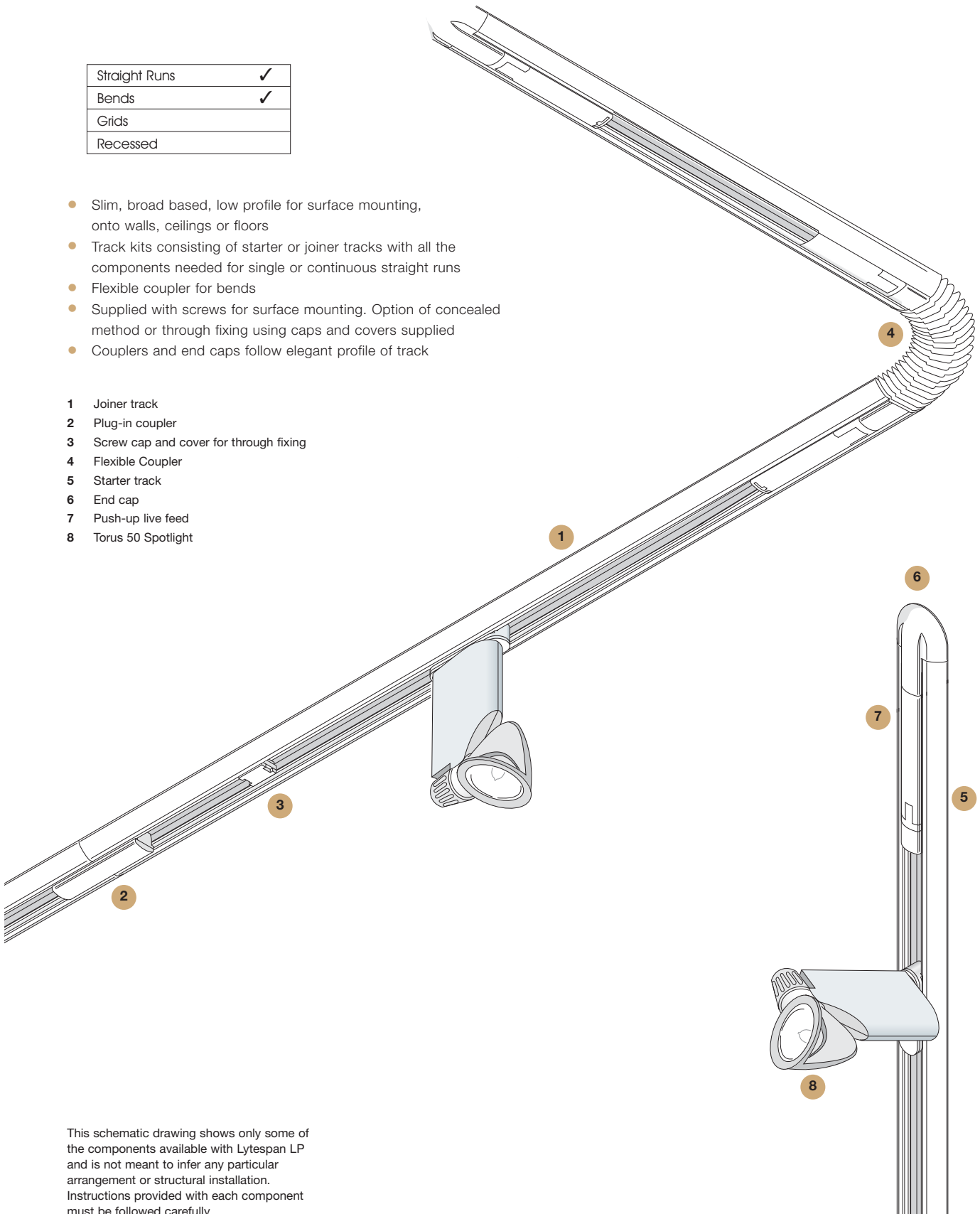

This schematic drawing shows only some of the components available with Lytespan LP and is not meant to infer any particular arrangement or structural installation. Instructions provided with each component must be followed carefully.

Lytespan LP

Single Circuit Track System

Track Kits

Starter Track

- Ideal for surface mounted runs
- Single length or to start a run
- Supplied with Track Unit, Push-up Live Feed, End Caps and Mounting Screws and Screw Cap Covers

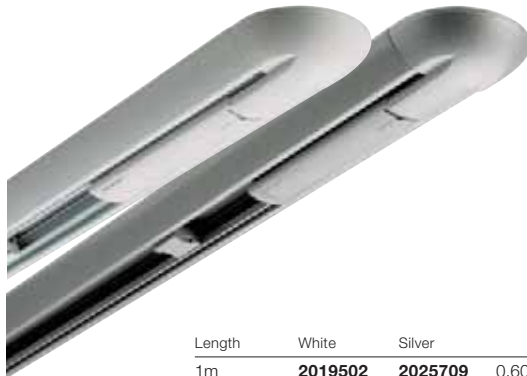

Length	White	Silver	
1m	2019502	2025709	0.60kg
2m	2019503	2025710	1.20kg
3m	2019504	2025711	1.80kg

Joiner Track

- Ideal for surface mounted runs
- Extends Starter Track to create straight runs.
- Supplied with Track Unit, Plug-in Live Coupler and Screws and Screw Cap Covers



Length	White	Silver	
2m	2019505	2025712	1.20kg
3m	2019506	2025713	1.80kg

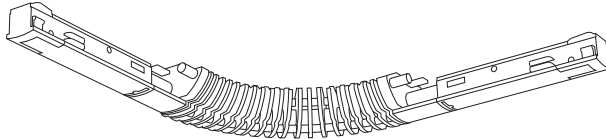

Flexible Coupler

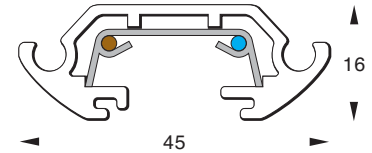

Standard LP

Coupler

			White	Silver
Flexible Coupler	Closes to a minimum of 45° horizontally Can easily be converted to mechanical only	Mech/Elec	2025994	2025995

Accessories

Flexible Cover Strip 10m	Covers track mouth to protect from dirt and dust	Ideal for floor mounted track	2025757
Display Hook	Suspends signs, cords etc	Max load 5.00kg	2007631
Nylon Toggle	M6 thread locks partitions etc into track	Max load 5.00kg	2007633
Fluorescent Adaptor Kit	For mounting and connecting surface fluorescents onto track	Max 4 amps	2011350

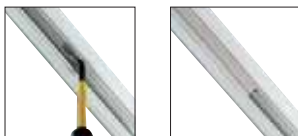

Concealed Fixing Starter track

- (Single run only) Fixing screw supplied
- Slide PVC Conductor Strip from aluminium extrusion
- Slotted screw keyholes are revealed
- The extrusion can be used as a template
- Screws can be installed at the predetermined centres
- The track can then be offered up and the screws tightened
- PVC conductor strip can then be returned to the extrusion



Through Fixing Starter and Joiner track

- (Continuous runs) Fixing screws and screw caps supplied
 - Screw caps push into the track at determined distances
 - Screw caps can be used as a drilling guide
 - When track section is firmly fixed, screw cap covers are pushed on to conceal the screw heads
- SAFETY! SCREW CAPS MUST BE USED**

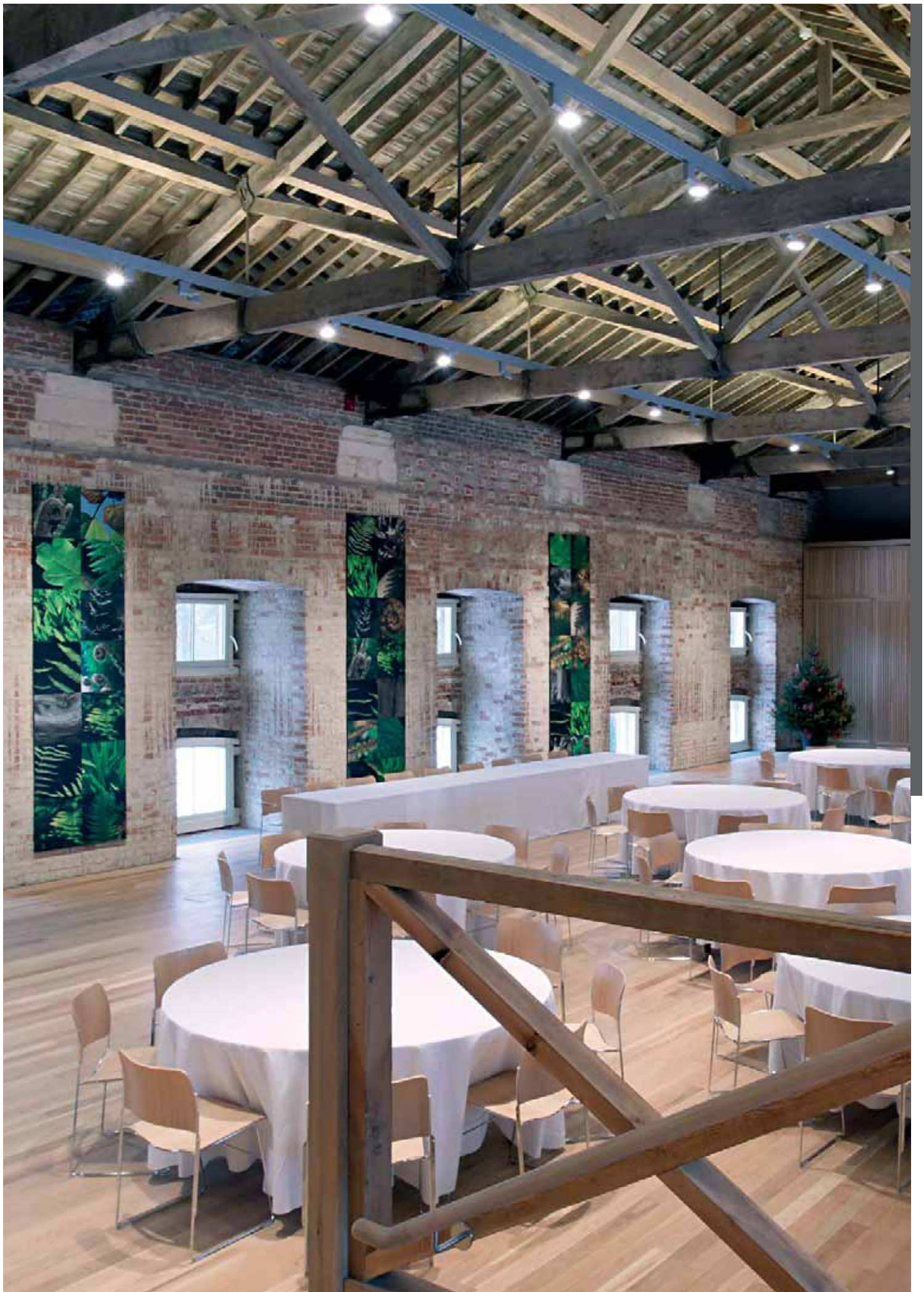

Three Circuit Track System



Push-up live feed supplies power at any point along the track length



Lytespan 3
Ideal for suspension or surface mounting

- Polarised 16amp three circuit track system with a common neutral
- Suitable for use with Concord:marlin and other European three circuit adaptors
- Each of the three circuits can be independently dimmed
- Unique Lytespan 3 'venturi' trunk profile in standard or recessed form
- Lytebeam deep trunk profile with empty back channel for cable way, T5 or Lytespan 3 module
- Couplers and feeds are pre-wired and polarised for ease of installation. See page 218 for planning aid
- Broad range of universal suspensions
- Polarised and fully earthed to latest international standards
- LED Emergency Modules. See pages 196-197

*When dimming – Other circuits cannot contain non-dimmable luminaires such as metal halide

Construction:	Extruded aluminium profile PVC liner housing 4 copper conductors
Total Max Load:	240 (230) VAC supply 3840w (3680w) ÷ 3 Single fuse rated at 16amps Supply cable 5 x 1.5mm ² 415 (400) VAC supply* 3840w (3680w) x 3 Each circuit separately fused at 16amps Supply cable 5 x 2.5mm ² * 3 phase track connection not allowed in the UK For other countries please check local wiring regulations
Finish:	Smooth polyester powder paint finish white RAL 9016, silver RAL 9006 or black RAL 9005

Three Circuit

Track Systems

Planning Aid

- Lytespan 3 track features a polarisation channel running along one side of its entire length. (See opposite)
- All Lytespan 3 feeds and couplers except Live Ends are supplied pre-polarised, with wires for ease of installation
- When planning a scheme it is important that:
 - The polarisation channel is continuous around corners and grids
 - The layout shows the correct view from **above**

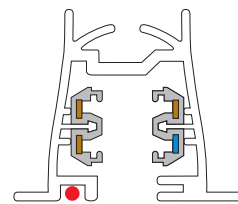

Polarisation Channel

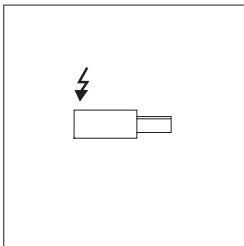

Plug-in live End
UNIVERSAL

Polarity tab indicates correct way to wire

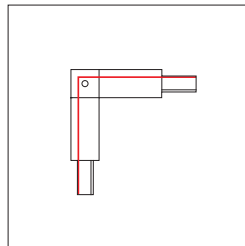

L Coupler
OUTSIDE

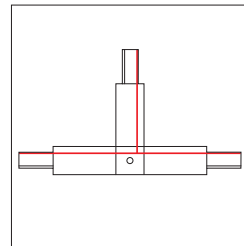

T Coupler
RIGHT

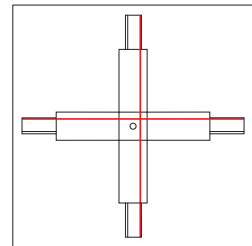

X Coupler
UNIVERSAL

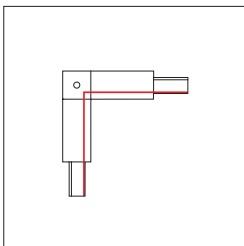

L Coupler
INSIDE

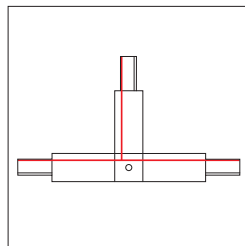

T Coupler
LEFT

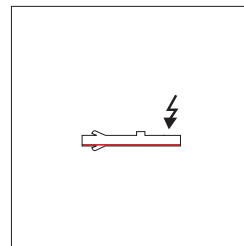

Push-up Feed
LEFT

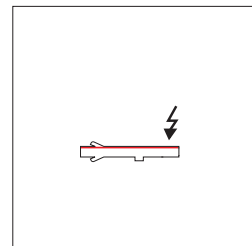

Push-up Feed
RIGHT



Planning from above

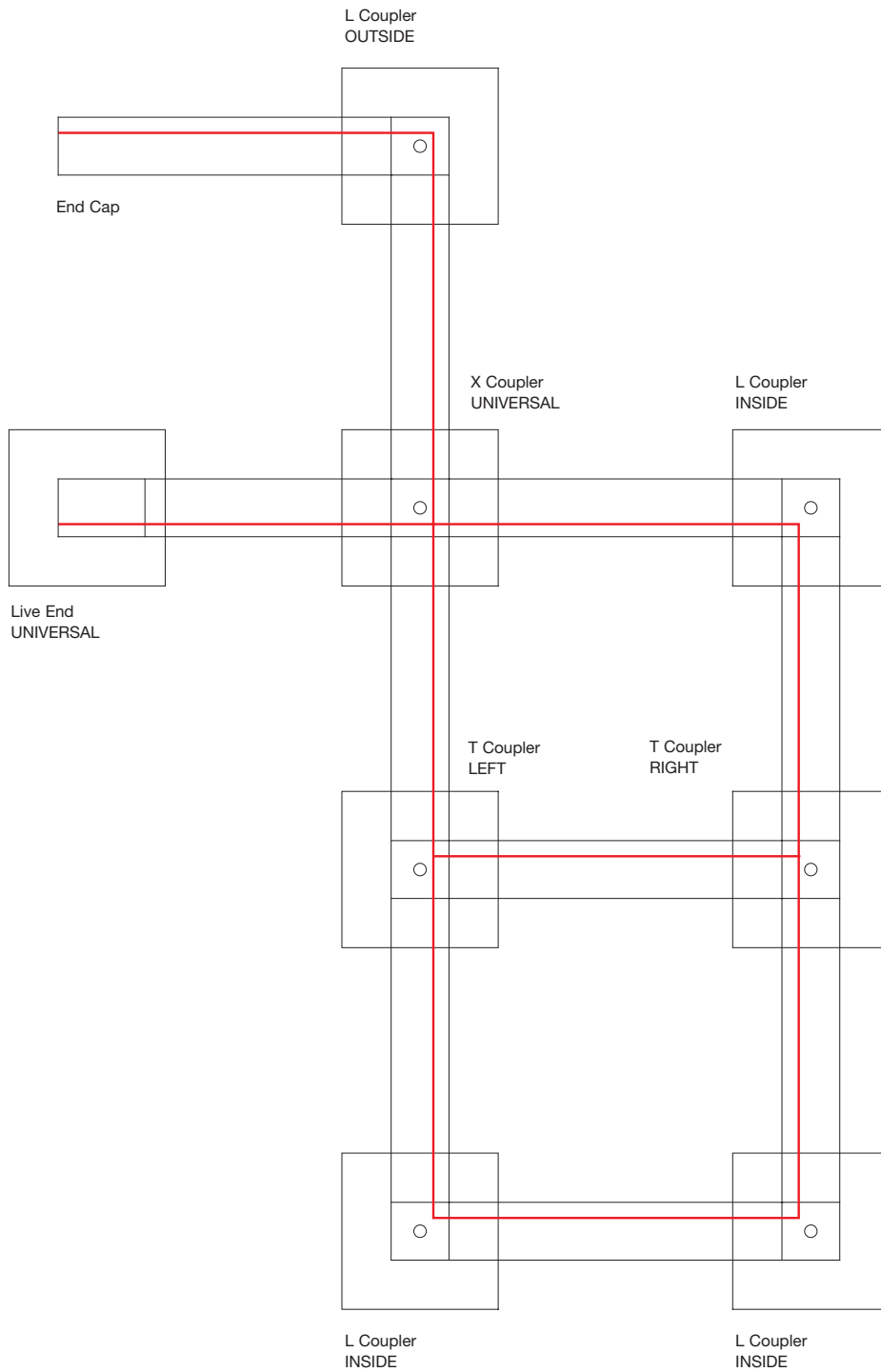

Lytespan 3

Three Circuit Track System

Straight Runs	✓
Bends	✓
Grids	✓
Recessed	✓

- Unique Venturi trunk profile
- Ideal for suspension or surface mounting
- Recessed track for suspended ceilings (straight runs only)
- Track kits consisting of starter and joiner tracks with all the components needed for single or continuous, surface mounted straight runs
- Track units and system components enable a scheme to be created to individual requirements
- Broad selection of universal suspensions
- Couplers and other components designed to follow profile of track

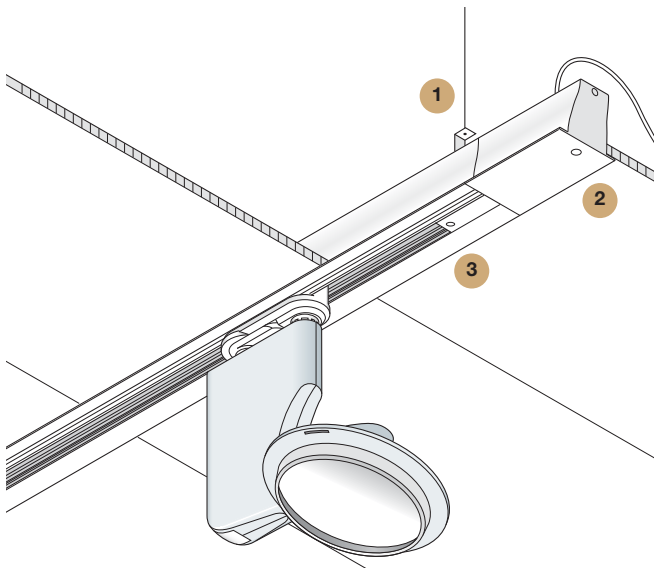

- 1 Recessed Suspension Bracket
- 2 Recessed Plug-in Live End
- 3 Recessed Track Unit
- 4 Torus 100FX Spotlight

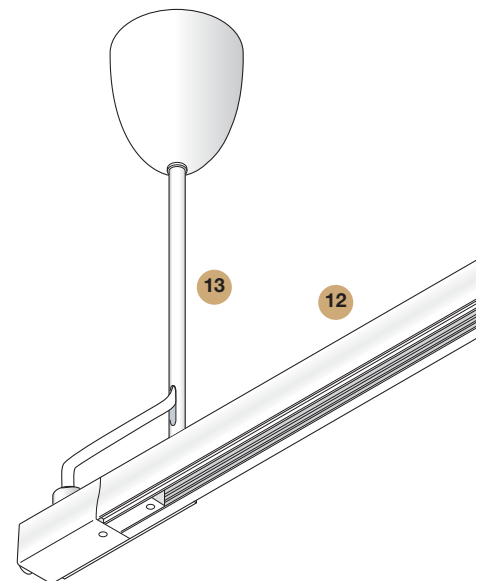

Lytespan 3

Three Circuit Track System

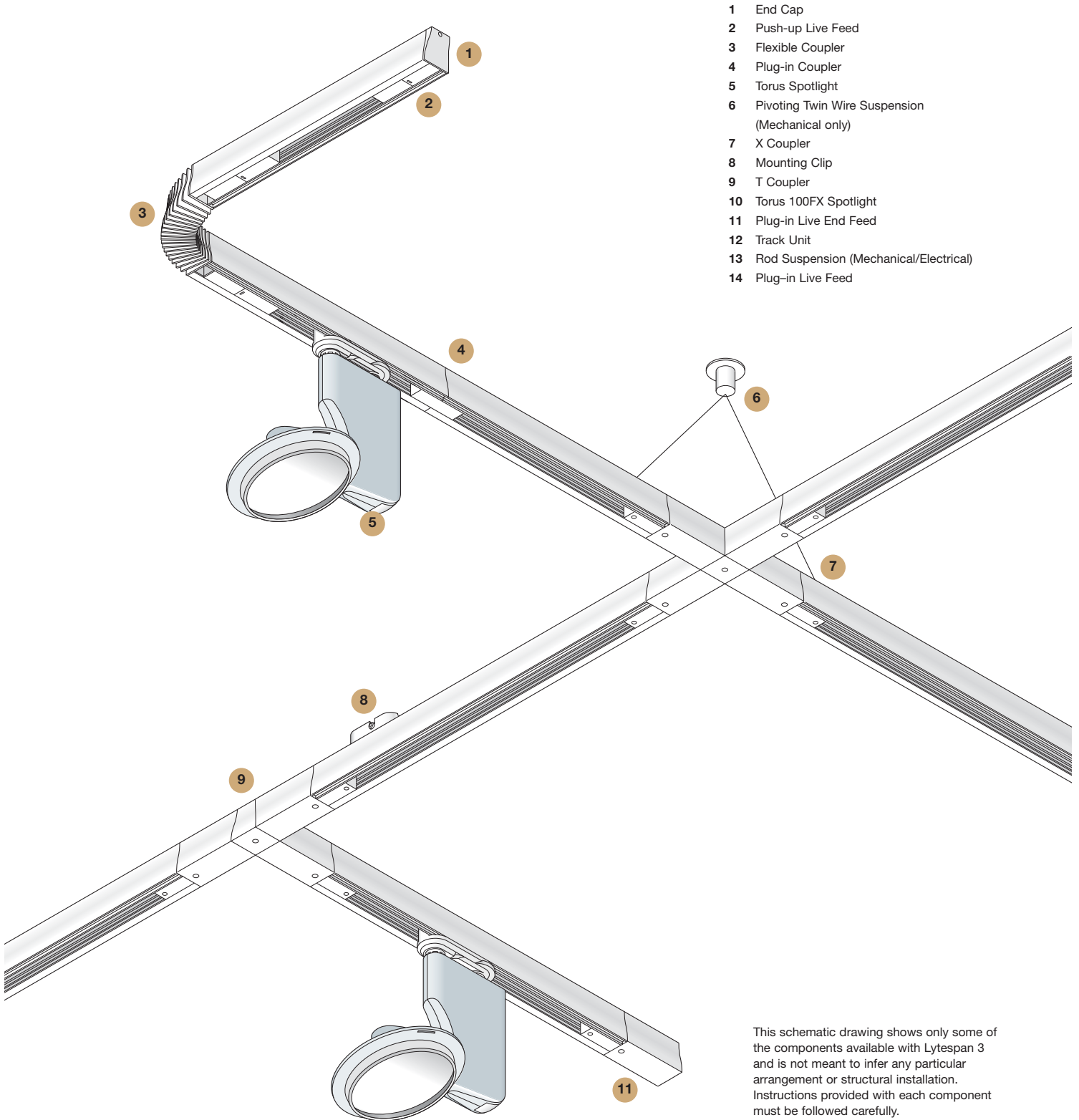

- 1 End Cap
- 2 Push-up Live Feed
- 3 Flexible Coupler
- 4 Plug-in Coupler
- 5 Torus Spotlight
- 6 Pivoting Twin Wire Suspension (Mechanical only)
- 7 X Coupler
- 8 Mounting Clip
- 9 T Coupler
- 10 Torus 100FX Spotlight
- 11 Plug-in Live End Feed
- 12 Track Unit
- 13 Rod Suspension (Mechanical/Electrical)
- 14 Plug-in Live Feed

This schematic drawing shows only some of the components available with Lytespan 3 and is not meant to infer any particular arrangement or structural installation. Instructions provided with each component must be followed carefully.

Lytespan 3

Three Circuit Track System

See p.196 for emergency lighting solutions for track mounting, p.199 for suspensions.

Track Kits

Starter Track Kit

- Ideal for surface mounted runs
- Single length or to start a run
- Supplied with Track Unit, Push-up Live Feed, End Caps and Surface Mount Clips



Length	White	
2m	2030733	1.85kg
3m	2030734	2.75kg

Joiner Track Kit

- Ideal for surface mounted runs
- Extends Starter Track to create straight runs
- Supplied with Track Unit, Plug-in Live Coupler and Surface Mount Clips



Length	White	
3m	2030736	2.90kg

Track Units and Components

Basic components required for a track scheme:

- 1 Track Unit
 - 2 Live Feed: Feeds power onto track
 - 3 Coupler: Only required if creating runs
 - 4 End Cap: Safely terminates track ends
 - 5 Suspensions: Safely and securely mounts track
- Optional** Accessories

Standard Track Unit

- For single or continuous runs and grids
- Ideal for surface mounting or suspension
- Order components and accessories separately

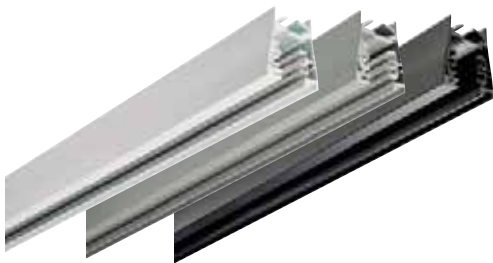

Length	White	Silver	Black	
1m	2020760	2020761	2025500	0.90kg
2m	2020762	2020763	2025501	1.80kg
3m	2020751	2020759	2025502	2.70kg
4m	2020787	2020788	2025503	3.60kg

Recessed Track Unit

- For single or continuous runs
- Ideal for suspended ceilings
- Order components and accessories separately



Length	White	
2m	2020718	1.95kg
3m	2020719	2.85kg
4m	2020720	3.75kg

Lytespan 3

Three Circuit Track System

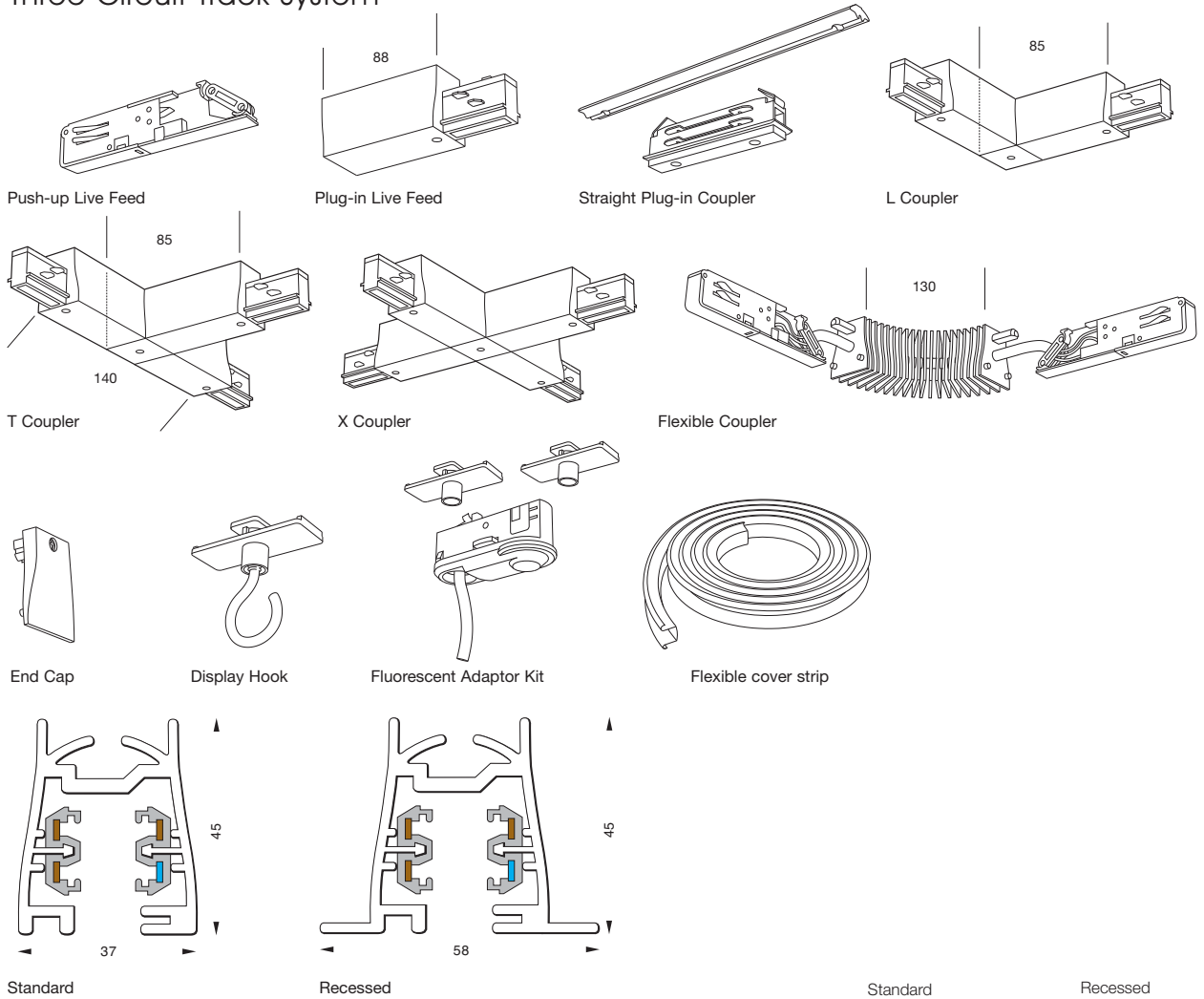

2 Live Feeds

			Standard Track	Standard Track	Recessed Track	Recessed Track
			White	Silver	Black	White
Push-Up Live Feed	Feeds power on or off anywhere along length of track	Left	2027546	2027547	2027548	2027546
		Right	2027549	2027550	2027551	2027549
Plug-In Live Feed	Feeds power on or off at end of track	Universal	2020790	2021318	2025507	2020799

3 Couplers

Straight Plug-in Coupler	Connects tracks to create straight runs	Mech/Elec	2020797	2027542	2025508	-
L Coupler	Polarised couplers supplied pre-wired for ease of installation*	Inside	2020792	2021315	2025511	-
		Outside	2020793	2021314	2025512	-
T Coupler	Polarised couplers supplied pre-wired for ease of installation*	Left	2020795	2021313	2025514	-
		Right	2020796	2021312	2025513	-
X Coupler	Polarised couplers supplied pre-wired for ease of installation*	Universal	2020794	2021311	2025515	-
Flexible Coupler	Closes to a minimum of 45° horizontally Can be easily removed to mechanical only	Mech/Elec	2020798	2021310	2025516	-

* Wires can be removed to create mechanical only connections. Once wires are removed couplers can be used to feed power on/off of track

4 End Cap

End Cap	Must be used to safely terminate track ends	2020789	2021317	2025517	-
---------	---	---------	---------	---------	---

5 Suspensions

Accessories

Flexible Cover Strip (10m)	Covers track mouth to protect from dirt and dust Ideal for floor mounted track	2025757	-	-	2025757
Display Hook	Suspends signs, cords etc. Max load 5.00kg	2025697	-	-	2025697
Fluorescent Adaptor Kit	For mounting and connecting surface fluorescents onto track Max 4 amps	2019213	-	-	2019213

Lytebeam

Three Circuit Direct/Indirect Track system

Straight Runs	✓
Bends	
Grids	✓
Recessed	

- Architectural three circuit deep beam section
- Indirect ambient lighting using T5 batten accessory
- Indirect accent lighting using L3 Track assembly
- Wide selection of suspension options, wires, rods and wall brackets
- Rigid section provides maximum suspension spacing of up to 4m
- Rear beam section may be used to carry other electrical services
- Wall brackets allow for wall to wall installation, maximum spacing 4m (longer with suspensions)
- Individual section, continuous runs and complex grids

- 1 End Cap
- 2 'L' Outside
- 3 'X'
- 4 'T' Right
- 5 'I' Inline Straight Connector
- 6 Single Wire Suspension
- 7 Wall Mounting Bracket
- 8 Mechanical/Electrical Single Wire Suspension
- 9 Push-up Live Feed
- 10 Twin Wire Suspension
- 11 Suspension Beam End

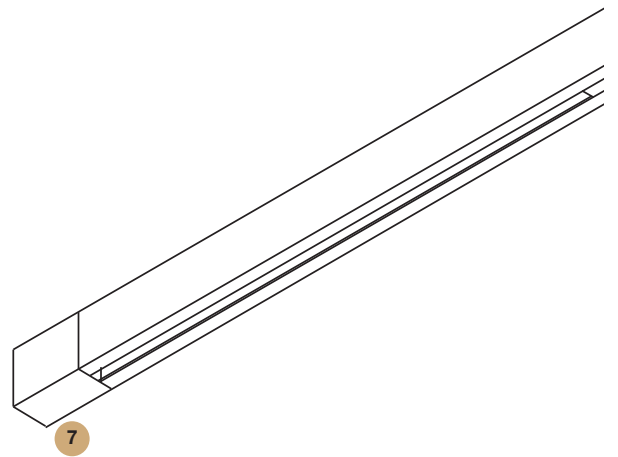

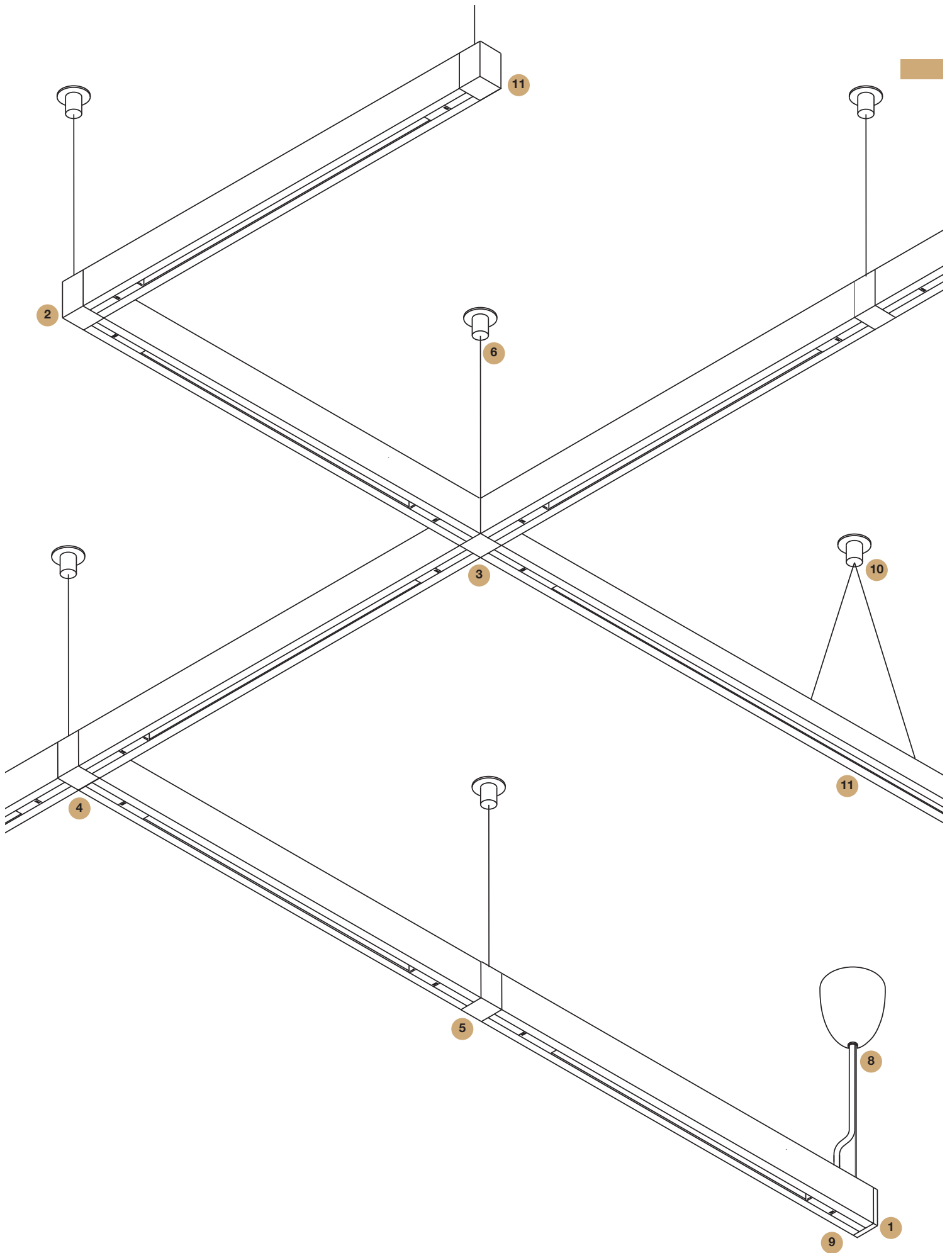

Lytebeam

Three Circuit Direct/Indirect Track system

Track Units and Components

Basic components required for a track scheme:

- 1 Track Unit
- 1a Indirect L3 track module
- 1b Indirect T5 batten module
- 2 Live Feed: Feeds power onto track
- 3 Coupler: Only required if creating runs
- 4 End Cap: Safely terminates track ends
- 5 Suspensions: Safely and securely mounts track

Optional Accessories

1 Standard Lytebeam Unit

- For single or continuous runs and grids
- **Order components and accessories separately**

Length	White	Silver	
2m	2037837	2037841	5.00kg
3m	2037838	2037842	7.50kg
4m	2037840	2037843	10.00kg

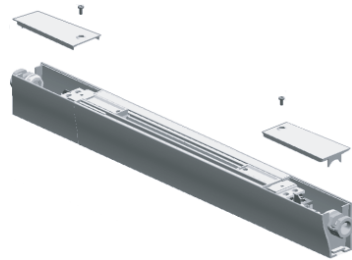

1a Indirect L3 track module

Length		
1.180m	2037845	1.20kg

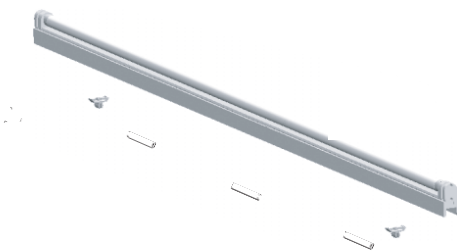

1b Indirect T5 batten module

Length		
1.186m	9137867	0.40kg

Provided with 2m lead with bare ends and 300mm interconnective lead for continuous-row mounting

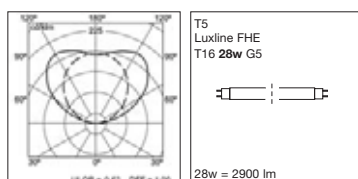

1 Empty Back Chanel for Cable Way

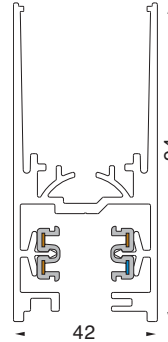

See p.196 for emergency lighting solutions, p.199 for suspensions.



1a L3 Track for Indirect Accent



1b T5 Fluorescent Modules for Indirect Ambient

Lytebeam Indirect L3 Modules – suggested spacings

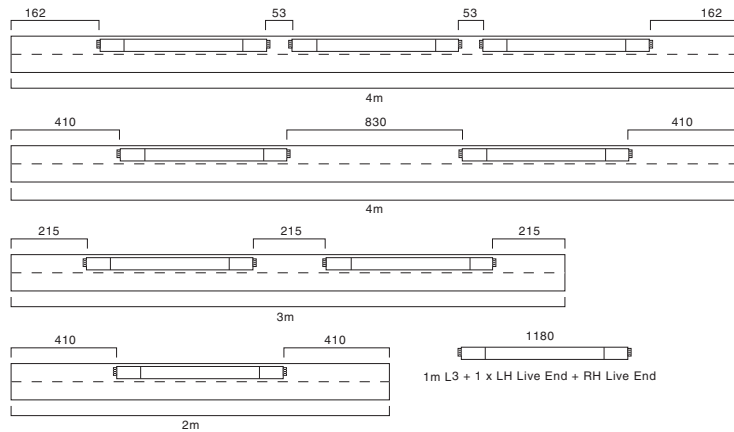

Lytebeam Indirect T5 Modules – suggested spacings

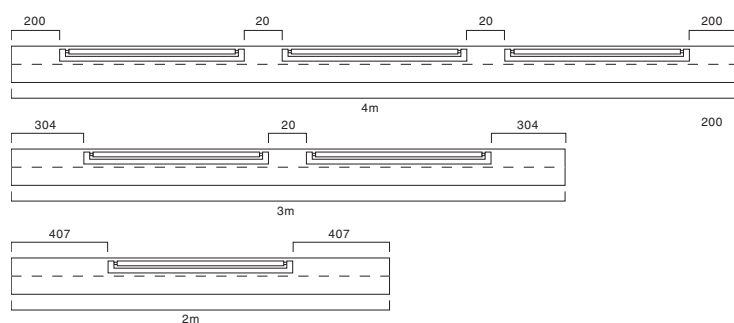

Three Circuit Direct/Indirect Track system

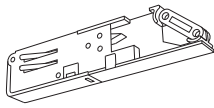

Push-up Live Feed



Push-up live feed supplies power at any point along the track length

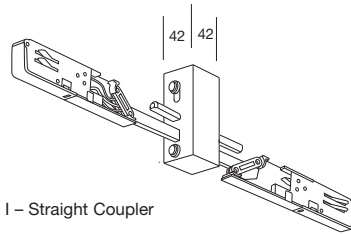

I - Straight Coupler

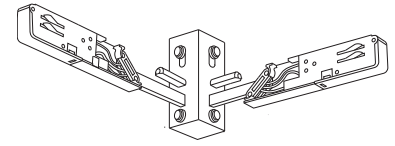

L - Coupler Inside/outside (converts)

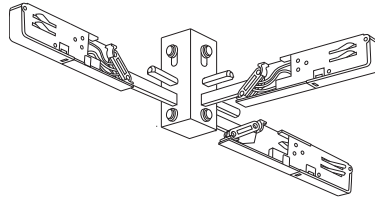

T - Left Hand and Right Hand

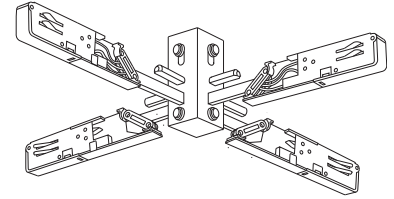

X - Universal

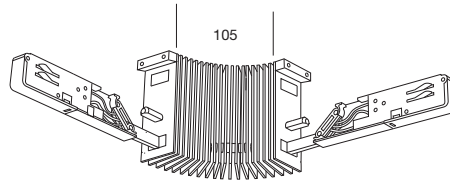

Flexible Coupler - Universal

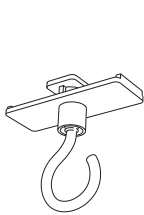

Display Hook

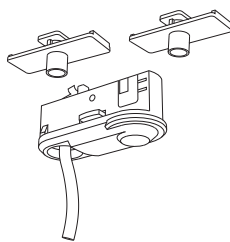

Fluorescent Adaptor Kit

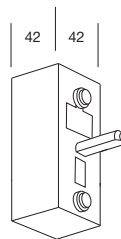

Beam End

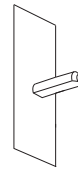

End Cap

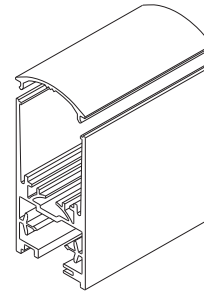

Dust Cover

2 Live Feeds

Push-Up Live Feed	Feeds power on or off anywhere along length of track	Left Right	White 2027546 2027549	Silver 2027547 2027550
-------------------	--	---------------	-----------------------------	------------------------------

3 Couplers

I Straight Coupler	Connects tracks to create straight runs	Mech/Elec	2037853	2037858
L Coupler	Polarised couplers supplied pre-wired for ease of installation*	Inside/Outside	2037854	2037860
T Coupler	Polarised couplers supplied pre-wired for ease of installation*	Left Right	2037855 2037856	2037861 2037862
X Coupler	Polarised couplers supplied pre-wired for ease of installation*	Universal	2037857	2037863
Flexible Coupler	Closes to a minimum of 60° horizontally	Mech/Elec	2037864	2037865

* Wires can be removed to create mechanical only connections. Once wires are removed couplers can be used to feed power on/off of track

4 End Cap

End Cap	Must be used to safely terminate track ends	2037848	2037850
Beam End	Must be used to safely terminate track ends and provides suspension points	2037851	2037852

5 Suspensions

See page 199

6 Optional Accessories

Display Hook	Suspends signs, cords etc.	Max load 5.00kg	2025697
Fluorescent Adaptor Kit	For mounting and connecting surface fluorescents onto track	Max 4 amps	2019213
Dust Cover	1m top dust cover (pack of 4)		2037866

Lytespan 3

LED Emergency

- **NEW** three circuit LED 3 hour non-maintained emergency module
- LED solutions offers considerable extended lamp life
- Can avoid requirement for additional emergency solution
- Module can be installed anywhere along a Lytespan 3 track installation
- Module consists of;
 - Gear with inverter and LED driver for 2x1W LED's connected to push-up live feed
 - 2 LED housings and one green charge indicator
- Module easily fits into track with double ended track fixings – feed connection discretely hidden behind module
- Not suitable for wall or floor mounting



Emergency Module - for Three Circuit Track	White	Silver	
Emergency Track Module	2038962	2038963	1.13kg

See p.190 for Lytespan 3,
p.199 for suspensions.

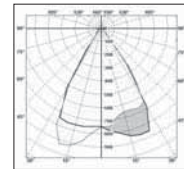

2038962

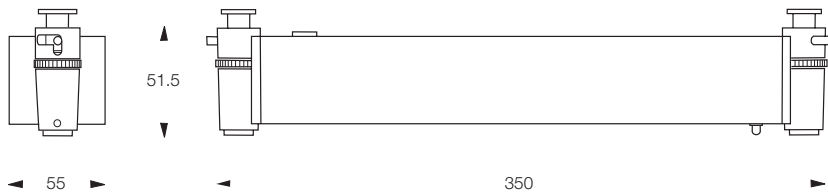

Module fits into track with double ended adaptor

Construction: Die cast aluminium
 Mounting: Track: Metal track fixings
 Polycarbonate live feed
 Control Gear: 3 hour non-maintained emergency Integral electronic gear
 Battery: Three cell NI-Cd/NiMH Battery 3.6V
 Finish: powder coated, white RAL 9016, silver RAL 9006

Lytebeam

LED Emergency

- **NEW** Lytebeam LED 3 hour non-maintained emergency kit
- LED solutions offers considerable extended lamp life
- Can avoid requirement for additional emergency solution
- Kit can be installed anywhere along a Lytebeam track installation
- Kits consist of;
 - Dear tray with inverter and LED driver for 2x1W LED's
 - 2 LED housings and one green charge indicator
 - 1m safety rear cover plate
- LED Housings easily clip into front of Lytebeam by drilling 2x12mm holes
- Gear fits into rear channel and connected to LED's via terminal block
- Rear safety cover plate conceals gear tray and internal wiring

Emergency Kit - for Lytebeam

Lytebeam Emergency Kit	2038312	0.75kg
------------------------	---------	--------

See p.192 for Lytebeam.

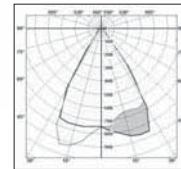
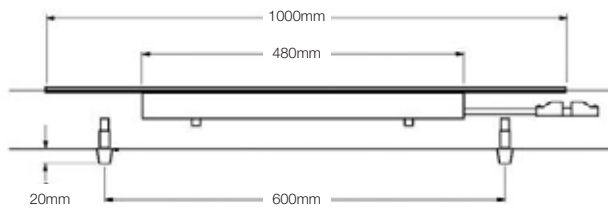

2038312



Discrete LED housings with green charge indicator in normal and emergency mode

- Construction: Aluminium and steel
- Control Gear: 3 hour non-maintained emergency Inverter and Batteries
- Battery: Three cell NI-Cd/NiMH Battery 3.6V
- Finish: anodised LED Housings and rear cover



Inverter pack and driver housed in the back of Lytebeam track sections



Universal Suspensions

Single & Three Circuit Track Systems

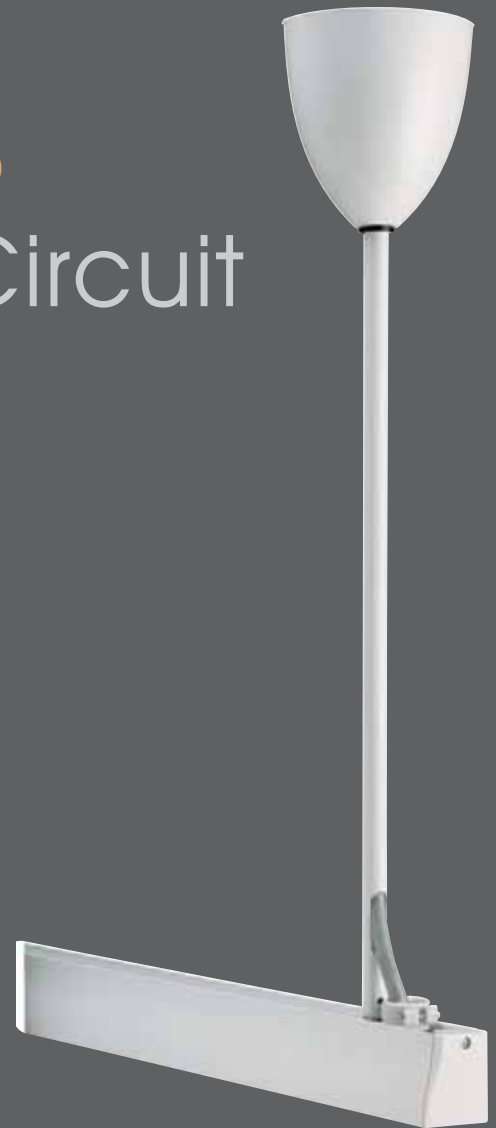

Rod Suspension (Mech/Elec)

- Rod and Floating suspensions provide rigid fixing up to 1m straight down from ceiling. Required for uneven loads or areas exposed to air movement
- Adjustable 3m wire suspensions provide the flexibility to fix from any angle, ideal for sloping ceilings
Longer lengths available as variants
- Clutch adjustment mechanism allows quick and easy installation and levelling. Excess wire can safely be removed
- Twin pivoting suspensions ideal for grids and corners
- Easy to wire mechanical and electrical rod and wiresuspensions enable discrete mains supply
- Wall mounting brackets for wall to wall installations (Lytebeam only)

Universal Suspensions

Single & Three Circuit Track System



Single Wire Suspension
(Mech only)



Twin Wire Suspension
(Mech Only)

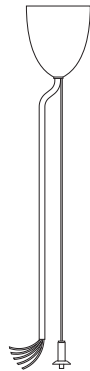

Single Wire Suspension
(Mech/Elec)

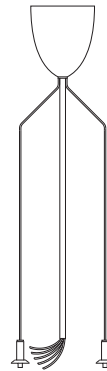

Twin Wire Suspension
(Mech/Elec)



Rod Suspension
(Mech only)



Wire Suspensions

		Length*	Max Load	Mech Only Chrome	Mech Only White	Single Circuit Elec/Mech White	Three Circuit Elec/Mech White
Single Wire Suspension	Length easily adjusted	3.00m	20.00kg	2035031	-	2035014	2035015
Twin Wire Suspension	Length easily adjusted	3.00m	20.00kg	2035016	-	2035017	2035018

Rod Suspensions

Rod Suspension	Can be cut on site from ceiling side only	0.50m		-	2035020	2035021	2035022
	+/- 5mm leveling adjustment	1.00m	25.00kg	-	2035023	2035024	2035025
Rod Extension	Screws onto Mechanical only rod suspensions	0.50m	25.00kg	-	2035026	-	-
	Can NOT be cut on site. Max drop 3.00m						
	+/- 5mm leveling adjustment						
Floating Suspension	+/- 5mm leveling adjustment	0.07m	25.00kg	-	2035027	-	-

Recessed Mounting

						White	Black
Suspension Bracket	For fixing recessed track into suspended ceilings	-	25.00kg			2011999	2011841

Surface Mounting

Mount Clip	Clip screw onto fixing surface. Track snaps onto back, secured with allen key supplied	0.14m	15.00kg			2011999	2011841
------------	--	-------	---------	--	--	----------------	----------------

Wall Mounting Bracket

Wall Mount Bracket		-	20.00kg			2037846	2037847
--------------------	--	---	---------	--	--	----------------	----------------

* Length refers to distance from mounting surface to back of track

Max spacing for all Single Circuit and Three Circuit Track systems 1.2m

Max spacing for Lytebeam 4m



Rod Extension
(Mech only)

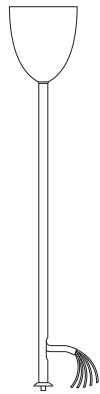

Rod Suspension
(Mech/Elec)



Wall Mounting
Bracket
(Lytebeam only)

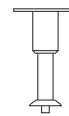

Floating Suspension
(Mech Only)
(Not Lytebeam)

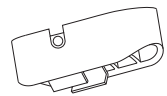

Mount Clip
(Not Lytebeam)

Track Deflection Data

The data below gives an indication of the max distributed and point loads that can be taken before deflection of track will occur.

**Do not exceed max load for individual suspensions.
Data is for max spacing or 1.2m**

Lytebeam track deflection data and maximum load

Max spacing for all Lytebeam suspensions 4m

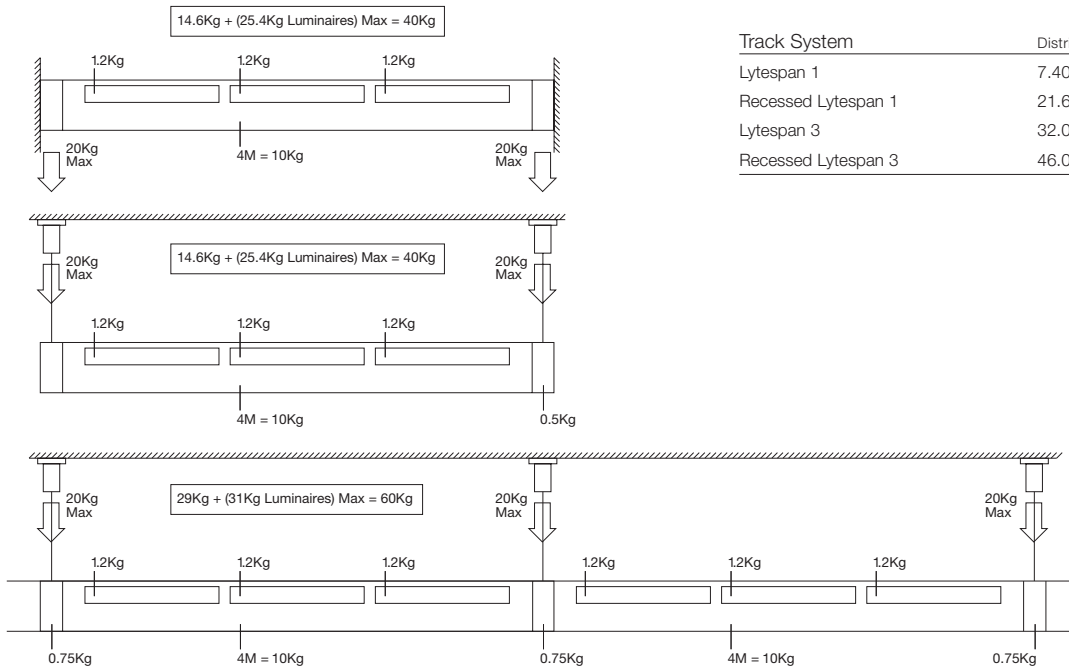

Other Track Systems

Max spacing is 1.2m

Track System	Maximum Allowable Load	
	Distributed	Point
Lytespan 1	7.40kg	4.60kg
Recessed Lytespan 1	21.60kg	13.50kg
Lytespan 3	32.00kg	20.00kg
Recessed Lytespan 3	46.00kg	28.50kg



Cassini

Pendant



- Direct/indirect light distribution
- Integral emergency options - suitable for use on defined escape routes
- Tamper resistant
- Main body of the fitting is IP65 rated to reduce dust ingress (Ceiling rose rated to IP20)

Control Gear:	Integral HF electronic gear
Emergency:	Integral, 3hr maintained
Diffuser:	Polycarbonate, satin opal, UV stabilised
IP65 Housing:	Polycarbonate, clear, UV stabilised
IP20 Rose:	Polycarbonate, white
Trim:	Aluminium polyester powder coated white RAL 9016, or brushed aluminium
Suspension:	Mechanical/electrical, 4m white electrical cable and stainless steel suspension wire, adjustable on site

Cassini Pendant

Planar

- Direct/indirect light distribution
- Integral emergency options - suitable for use on defined escape routes
- Tamper resistant
- Main body of the fitting is IP65 rated to reduce dust ingress (Ceiling rose rated to IP20)



Planar

Cassini Planar Pendant	White	Brushed Aluminum
38W TC-DD HF	4065629	4065633
38W TC-DD HF Emergency	4065630	4065634
2x26W TC-DEL HF	4065631	4065635
2x26W TC-DEL HF Emergency	4065632	4065636

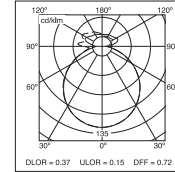
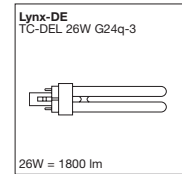
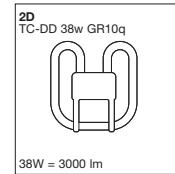
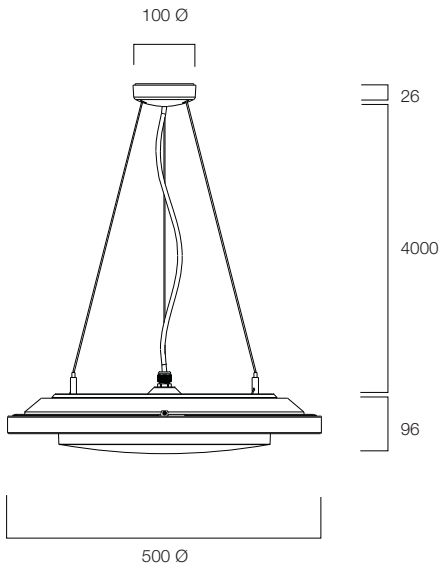

4065639



Matching wall mounted versions see page 94

Cassini Pendant

Radius

- Direct/indirect light distribution
- Integral emergency options - suitable for use on defined escape routes
- Tamper resistant
- Main body of the fitting is IP65 rated to reduce dust ingress (Ceiling rose rated to IP20)



Radius

Cassini Radius Pendant	White	Brushed Aluminum	Chrome
38W TC-DD HF	4065637	4065641	4065645
38W TC-DD HF Emergency	4065638	4065642	4065646
2x26W TC-DEL HF	4065639	4065643	4065647
2x26W TC-DEL HF Emergency	4065640	4065644	4065648

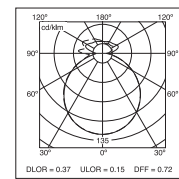
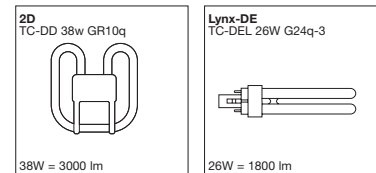
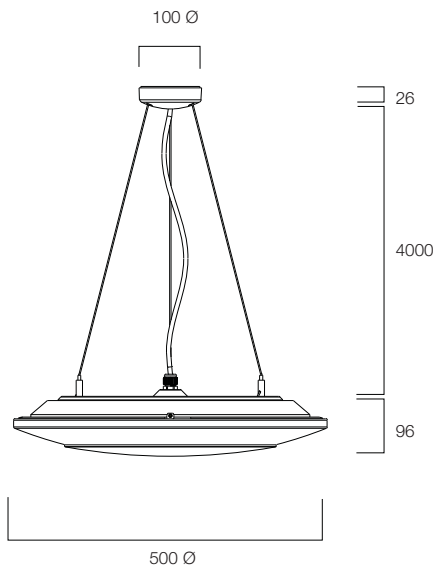

4065639



Matching wall mounted versions see page 95

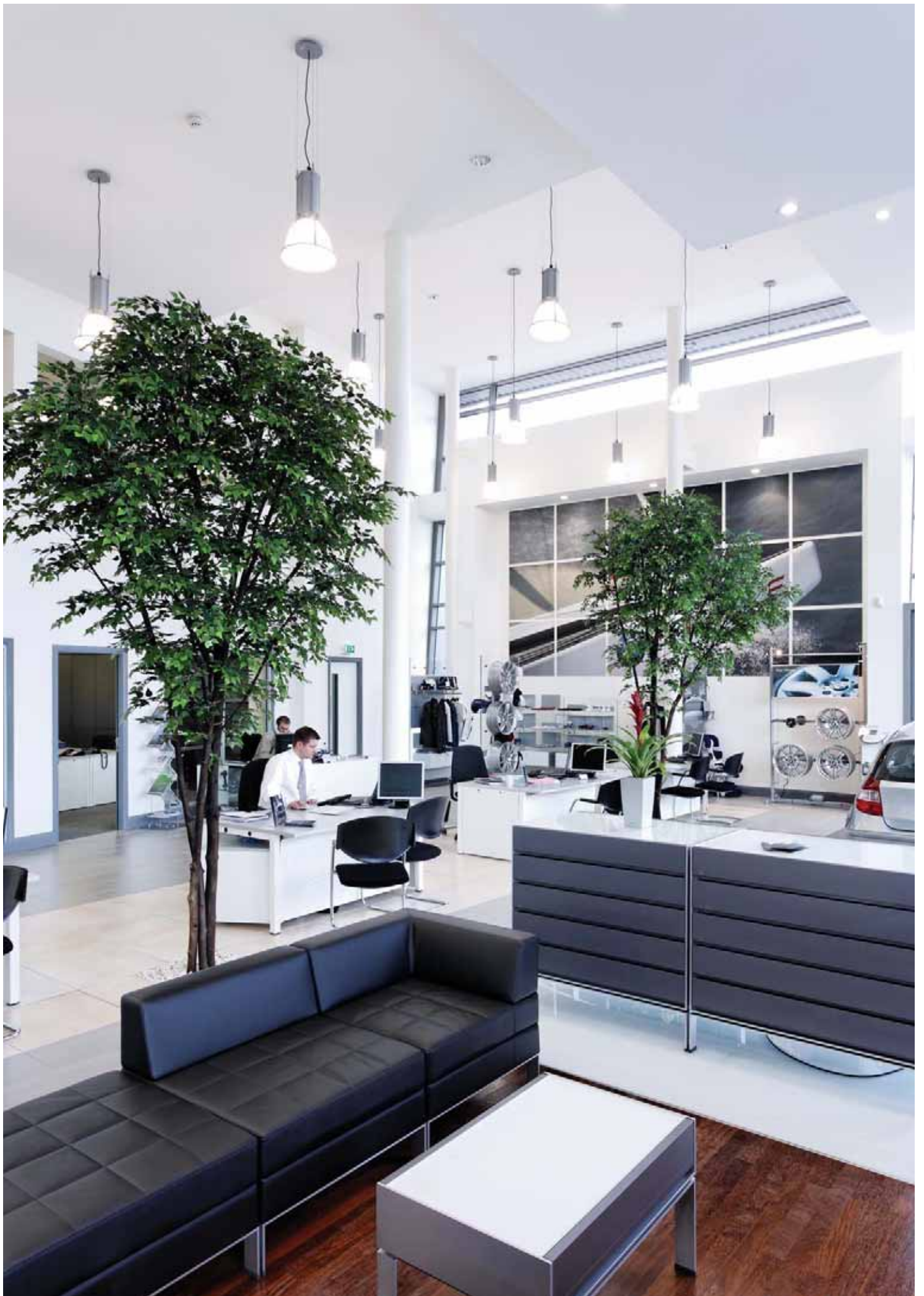

Trio Pendant

- Pendant for high output lamps
- CMI/CDM-T Versions supplied complete with safety glass
- Supplied with optional decorative bottom glass
- Choice of direct/indirect opal glass reflector or aluminium direct reflector
- Easy height adjustment with adjustable clutch wire suspension
- Top mounted socket with plug and flex to ceiling rose for ease of installation and maintenance



Opal Glass Reflector	White	Silver
70W HIT-CE	4065649	4065655
150W HIT-CE	4065651	4065657
3x26W TC-D	4065653	4065659

Aluminum Reflector	White	Silver
70W HIT-CE	4065650	4065656
150W HIT-CE	4065652	4065658
3x26W TC-D	4065654	4065660

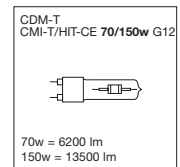
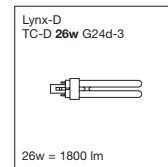
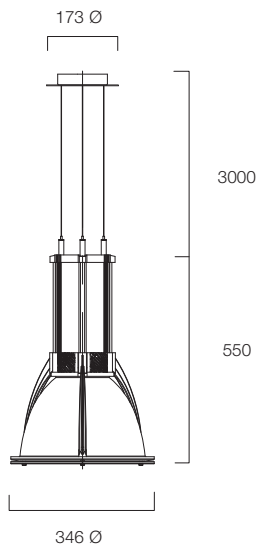

- Control Gear: Integral switch start HPF gear
 Housing: Die-cast aluminium, powder coated
 Finish: white RAL 9016 or silver RAL 9006
 Reflector: Opal glass or aluminium
 Suspension: Mechanical/electrical, 3m black electrical cable and stainless steel suspension wire, adjustable on site

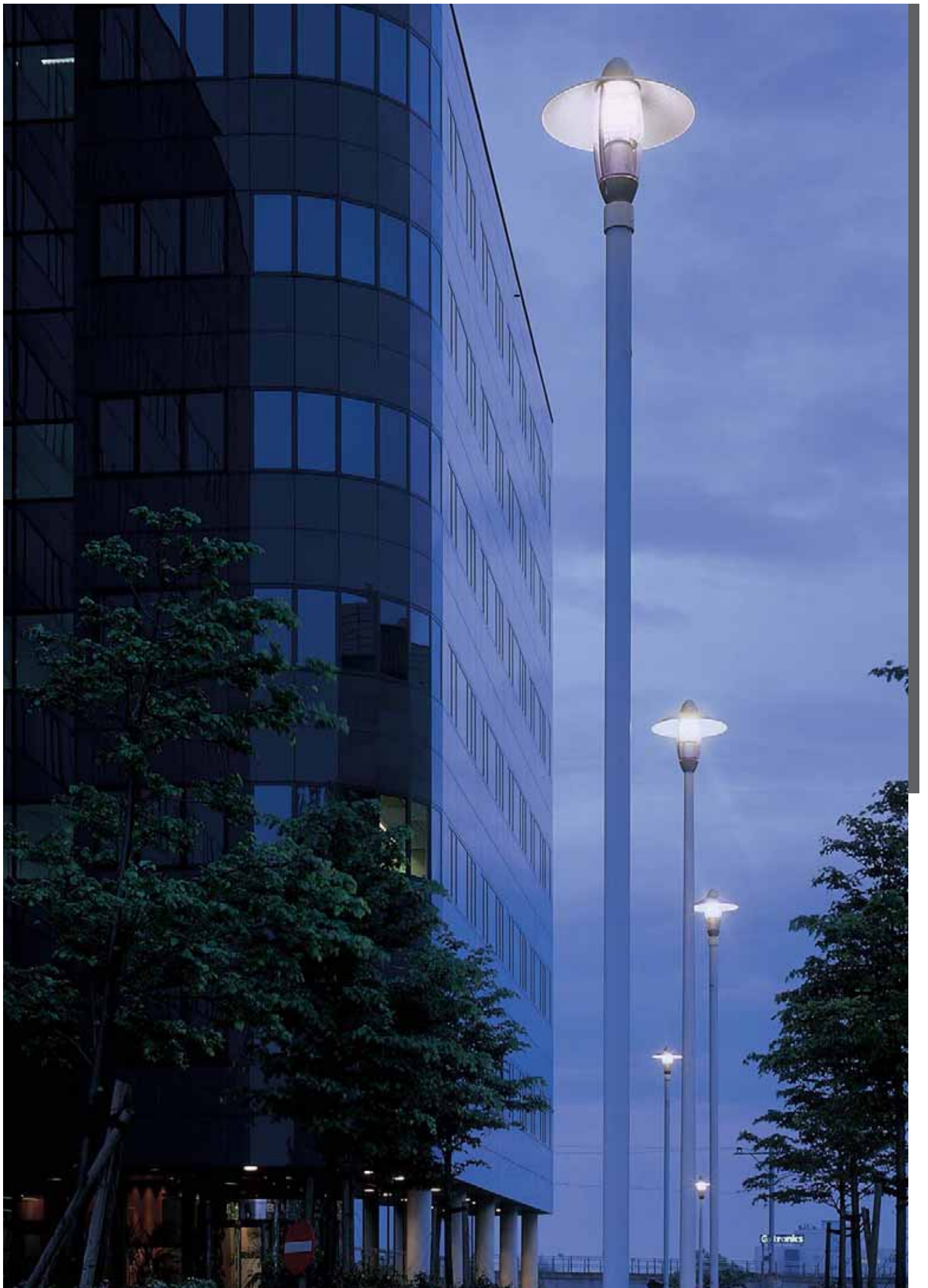

Skyline

Pole Top



Skyline 150w CDM-TT mounted on 4m columns at 6m centres

- Ideal for plazas, pedestrian areas, precincts, parks, etc
- Select from a wide choice of lamps
- Versatile mounting options for custom lantern arrangements
- Overall design provides good daytime presence

Control Gear:	HIE built in ballast, capacitor and ignitor HME built in ballast and capacitor HST built in ballast, capacitor and ignitor HIT-CE built in ballast, capacitor and ignitor TC-TEL integral electronic gear
Louvre:	Glass filled PET polyester
Housing:	Aluminium, anti corrosion pre-treated prior to powder coating black RAL 9005, silver RAL 9006
Retaining Screws:	Stainless steel
Fuse cut out box:	Fuse Type BS88 single body
Columns:	Galvanised steel, supplied black primed
Windage:	Column lantern : 0.10m ² Column lantern + canopy 1: 0.12m ² Column lantern + canopy 2: 0.15m ²

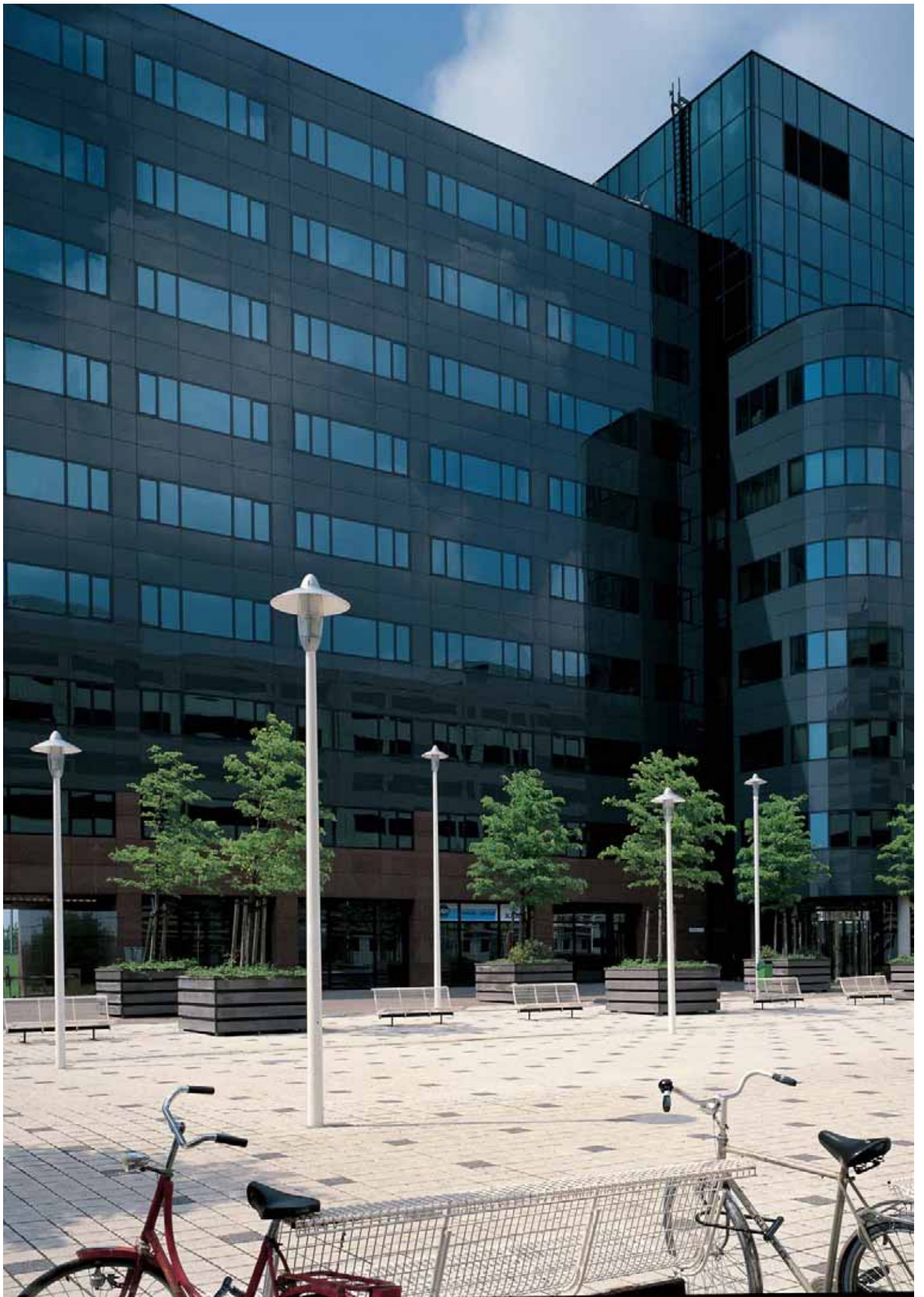

Skyline

Poletop

- Contemporary amenity lighting
- Offers visually appealing ambience after dark
- Versatile white light solutions with good colour rendering

IP65 conforms to EN 60.598



Lamp	Black	Silver	Weight
42w TC-TEL	4041094	4041095	7.20kg
100w HIE-CE	4041088	4041090	8.35kg
70w HST/HIT-CE	4041096	4041097	7.95kg
150w HST/HIT-CE	4041092	4041093	9.75kg

Column option

Height	Type	Root Mounted	Flange Plate Mounted
3m	Waisted	4061496	4061495
3m	Tapered	4061476	4061475
4m	Waisted	4061498	4061497
4m	Tapered	4061478	4061477
5m	Waisted	4061500	4061499
5m	Tapered	4061480	4061479
6m	Waisted	4061502	4061501
6m	Tapered	4061482	4061481

NOTE: Columns supplied black primed, final finishing required on site

Optional canopies

	Black	Silver	Weight
Canopy 1	4041059	4041060	1.65kg
Canopy 2	4041063	4041064	1.70kg

Fuse cut out box

Double pole/single phase,
facilitates armoured cable **4040716** 0.60kg

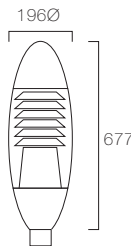
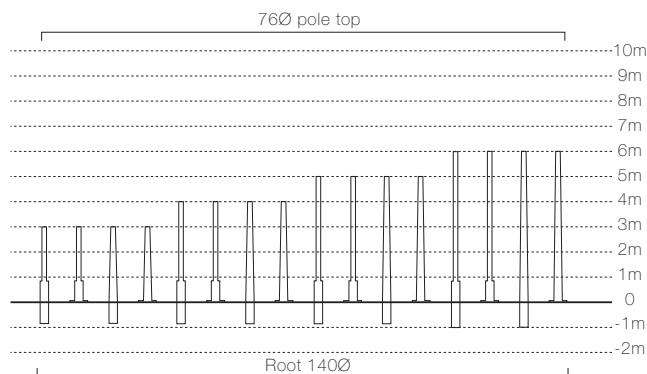

Standard version

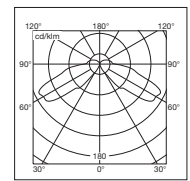

4041096

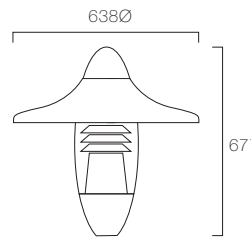

Canopy 1

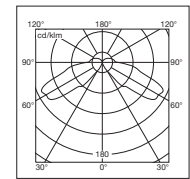

4041096 + 4041059

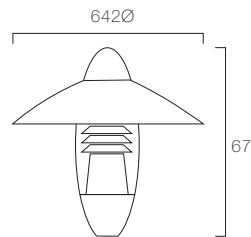

Canopy 2

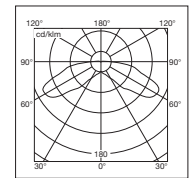

4041096 + 4041063

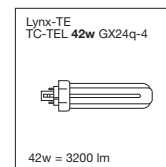
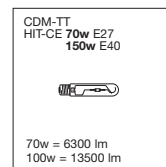
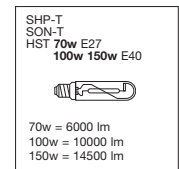
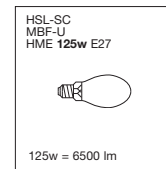
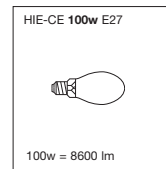

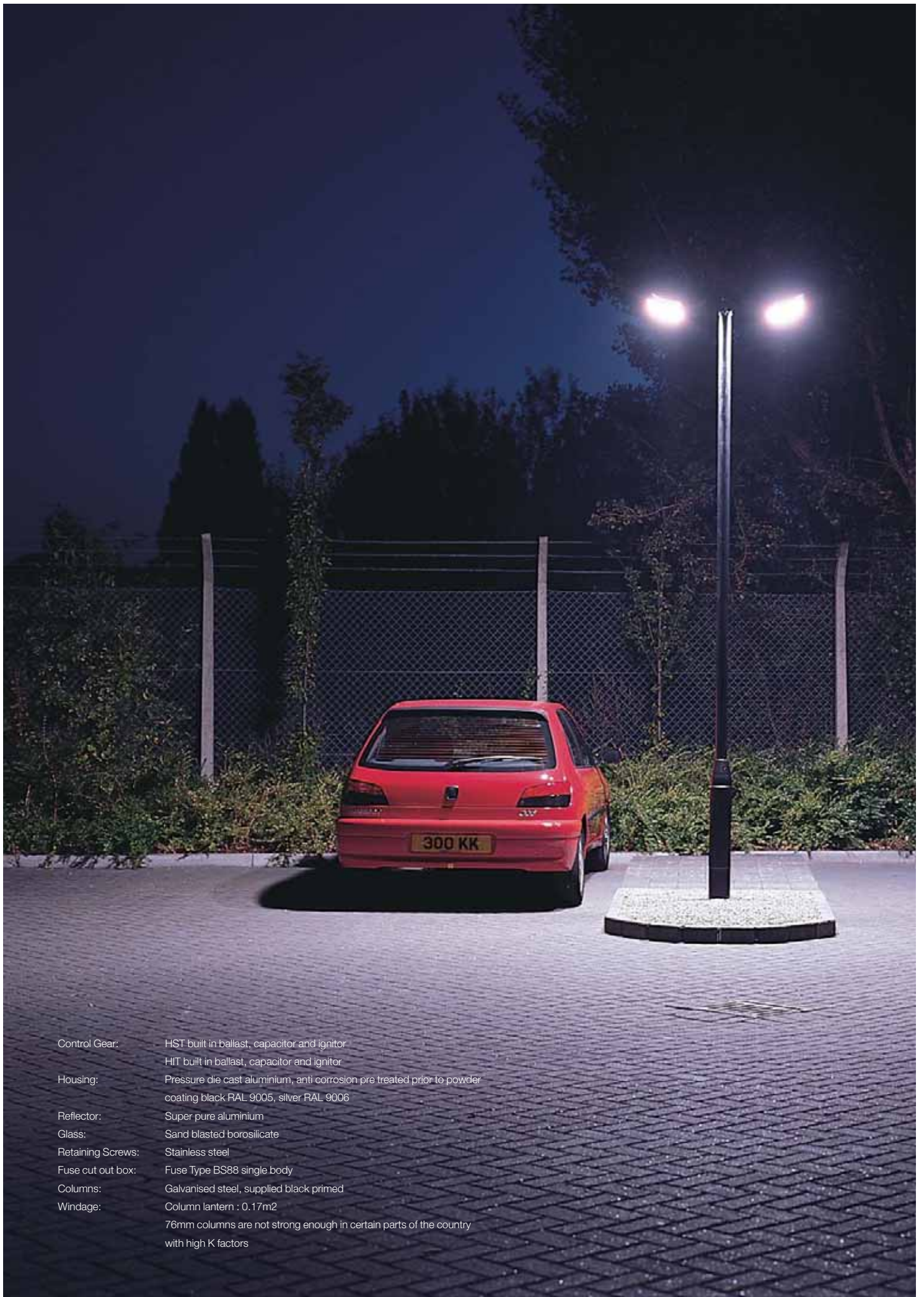

Control Gear: HST built in ballast, capacitor and ignitor
HIT built in ballast, capacitor and ignitor

Housing: Pressure die cast aluminium, anti corrosion pre treated prior to powder coating black RAL 9005, silver RAL 9006

Reflector: Super pure aluminium

Glass: Sand blasted borosilicate

Retaining Screws: Stainless steel

Fuse cut out box: Fuse Type BS88 single body

Columns: Galvanised steel, supplied black primed

Windage: Column lantern : 0.17m²
76mm columns are not strong enough in certain parts of the country with high K factors

Storm

Poletop

- Amenity, road and area lighting applications
- Unique ellipse styling
- Versatile mounting options for custom lantern arrangements
- Wall mounted or post top solutions

IP65 conforms to EN 60.598

Lamp

Housing		Black	Silver
70w HST/HIT-CE		4050881	4050882
100w HST		4050875	-
150w HST/HIT-CE		4050878	4050879

Supplied with 7 metre mains cable

Wall Mounting bracket

Type		Black	Silver
Single wall		4050903	4050914
Single wall, with surface cable entry		4050904	4050915

Column Mounting bracket

Type		Black	Silver
Single		4050901	4050912
Twin		4050902	4050913

76mm Steel Columns

Height	Type	Root Mounted	Flange Plate Mounted
3m	Waisted	4061496	4061495
3m	Tapered	4061476	4061475
4m	Waisted	4061498	4061497
4m	Tapered	4061478	4061477
5m	Waisted	4061500	4061499
5m	Tapered	4061480	4061479
6m	Waisted	4061502	4061501
6m	Tapered	4061482	4061481

NOTE: Columns supplied black primed, final finishing required on site

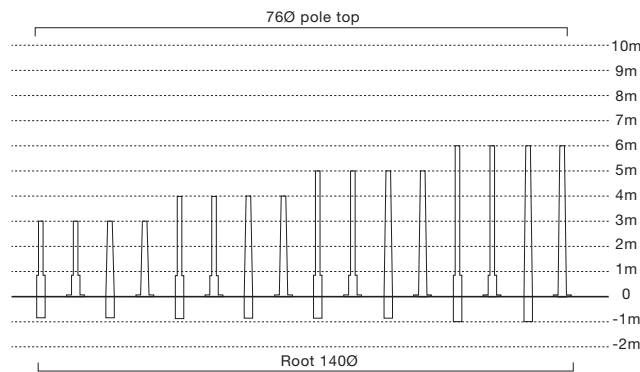

Accessories

Fuse cut out box

Double Pole – Single Phase	4040716	0.60kg
Double Pole – Single Phase + Photocell connection	4050798	1.00kg

NOTE: **4050798** for use with photocell **4050900** / **4050911** / **4050889** kits

Photocell		Black	Silver	
Column Mounted*		4050900	4050911	0.50kg
Wall Mounted		4050853		0.60kg

*Supplied with 7 metre mains cable

Concord:marlin

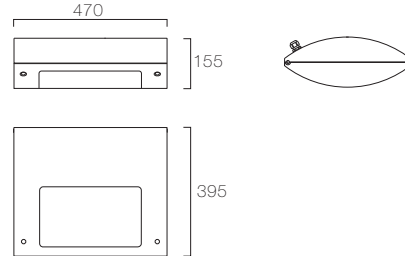

Wall mounting bracket

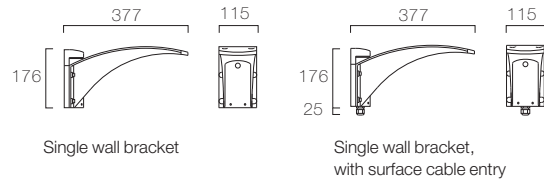

Column mounting bracket

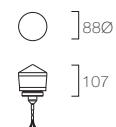
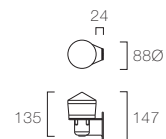
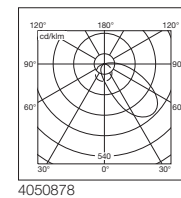
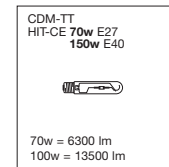
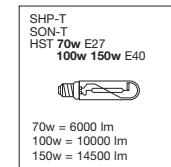
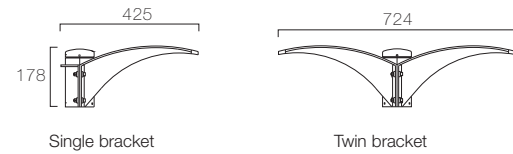

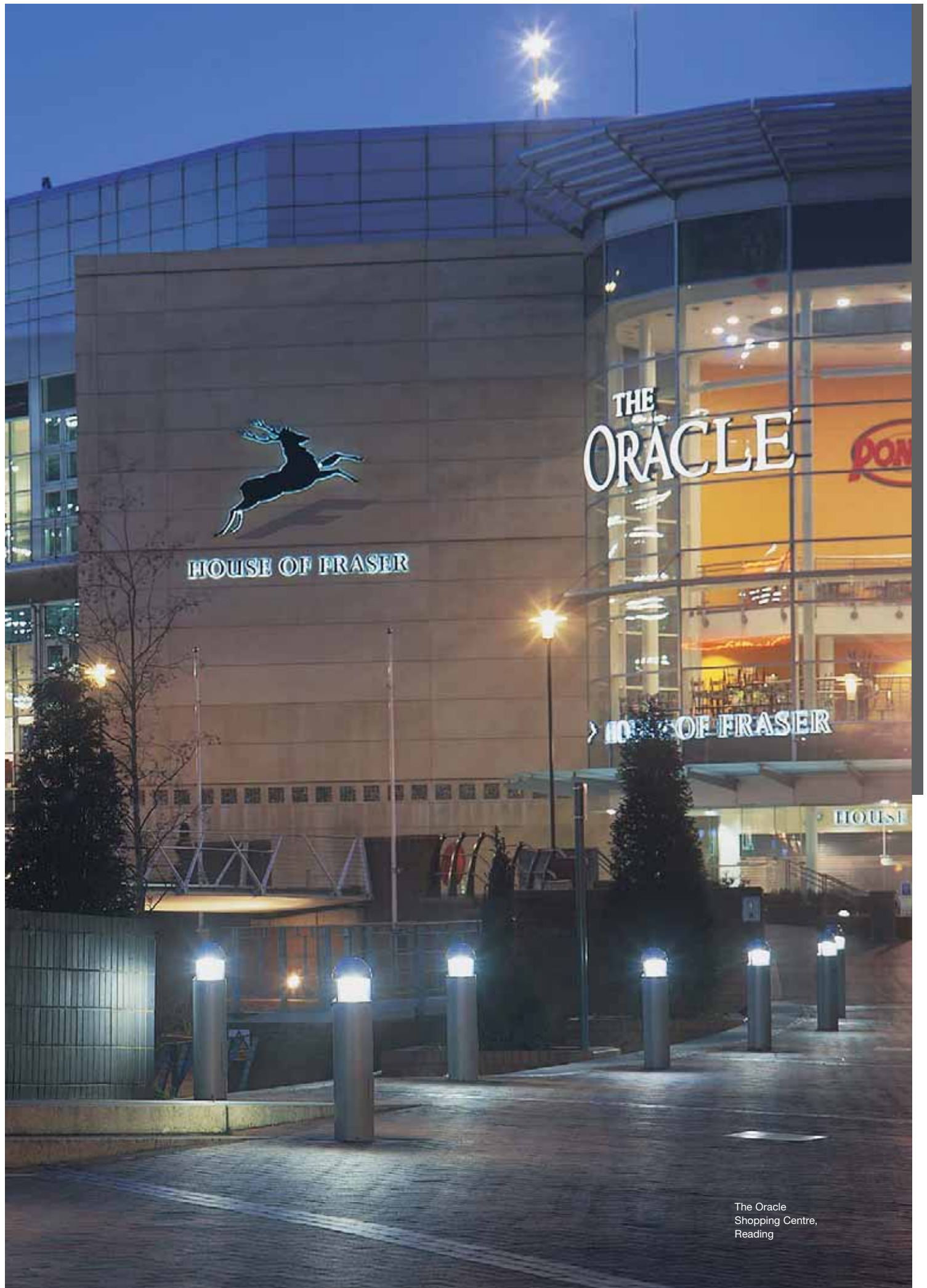

The Oracle
Shopping Centre,
Reading

Sterling Bollard

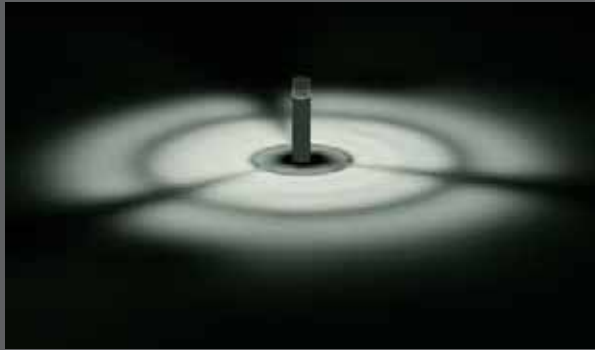

70w HIT-CE



Sterling bollard with stepped louvre



70w HIT-CE



Sterling bollard with stepped cone

- Sterling is a range of bollards for lighting paths and municipal areas
- The stepped cone versions have a baffle which obscures the direct view of the lamp
- Uniform ground illumination is achieved up to 7m from the bollard
- The stepped louvred version maintains even illumination up to a distance of 4m
- High corrosion resistance with chemical chromatised protection

Control Gear:	HME built in ballast and capacitor TC-T built in ballast and capacitor HST built in ballast, capacitor and ignitor HIT-CE built in ballast, capacitor and ignitor TC-TEL integral electronic gear
Head Assembly:	Pressure die cast aluminium
Diffuser:	Polycarbonate vandal proof
Body:	Extruded aluminium
Base & Root:	Super pure copper free aluminium
Root ties:	Stainless steel
Retaining Screws:	Stainless steel
Paint finish:	Anti corrosion pre-treated prior to powder coating, black RAL 9005, silver 9006
Fuse cut out box:	Fuse type BS88 single body

Mini Sterling Bollard

- Unique design making the range highly vandal resistant. IK10
- High performance optics allows wide spacing
- Glare free from typical walking and driving viewing angles
- New class 2 classification for improved electrical safety



IP65 IK10 conforms to EN 60.598 CE

Stepped louvre

800mm high	Domed top		Flat top		
Lamp	Black	Silver	Black	Silver	Weight
18w TC-T	SBMLD 1806	SBMLD 1812	SBMLF 1806	SBMLF 1812	5.10kg
35w HIT-CE	SBMLD 3506	SBMLD 3512	SBMLF 3506	SBMLF 3512	6.10kg

500mm high	Domed top		Flat top		
Lamp	Black	Silver	Black	Silver	Weight
18w TC-T	SBMLD 1806S	SBMLD 1812S	SBMLF 1806S	SBMLF 1812S	3.90kg
35w HIT-CE	SBMLD 3506S	SBMLD 3512S	SBMLF 3506S	SBMLF 3512S	4.90kg

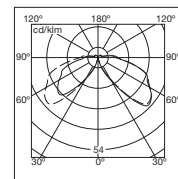

SBMLF18065

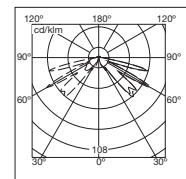

SBMLF35065

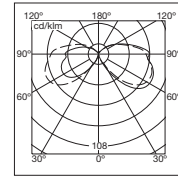

SBMCF1806

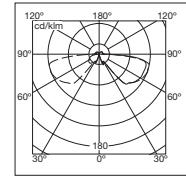

SBMLCF3506

Stepped cone

800mm high	Domed top		Flat top		
Lamp	Black	Silver	Black	Silver	Weight
18w TC-T	SBMCD 1806	SBMCD 1812	SBMCF 1806	SBMCF 1812	5.10kg
35w HIT-CE	SBMCD 3506	SBMCD 3512	SBMCF 3506	SBMCF 3512	6.10kg

500mm high	Domed top		Flat top		
Lamp	Black	Silver	Black	Silver	Weight
18w TC-T	SBMCD 1806S	SBMCD 1812S	SBMCF 1806S	SBMCF 1812S	3.90kg
35w HIT-CE	SBMCD 3506S	SBMCD 3512S	SBMCF 3506S	SBMCF 3512S	4.90kg

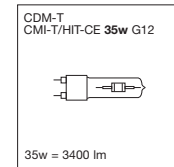
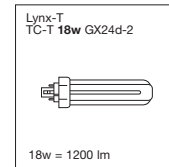

Accessory

Mounting root	(For setting into concrete when fixing into soil)	SBM ROOT
---------------	---	-----------------

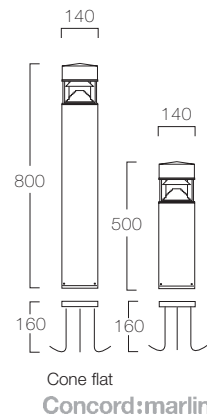
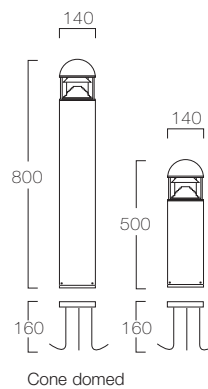
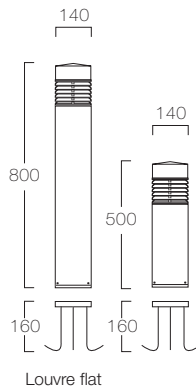
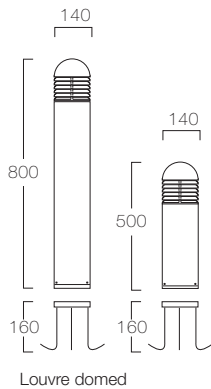

Sterling Bollard

- Unique design making the range highly vandal resistant. IK10
- High performance optics allows wide spacing
- Emergency compact fluorescent version to special order
- New class 2 classification for improved electrical safety

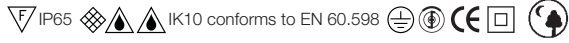

Stepped louvre 940mm high

Lamp	Domed top		Flat top		Weight
	Black	Silver	Black	Silver	
26/32/42w TC-TEL	4048951	4048954	4058343	4058344	11.40kg
50/80w HME	4040713	4040721	4058352	4058353	12.30kg
50w HST	4041749	4041750	4058346	4058347	12.30kg
70w HST/HIT-CE	4040714	4040722	4058349	4058350	12.30kg

Stepped louvre 450mm high

Lamp	Domed top		Flat top		Weight
	Black	Silver	Black	Silver	
26/32/42w TC-TEL	4061729	4061730	4061719	4061720	8.20kg
50/80w HME	4061735	4061736	4061725	4061726	9.10kg
50w HST	4061731	4061732	4061721	4061722	9.10kg
70w HST/HIT-CE	4061733	4061734	4061723	4061724	9.10kg

Stepped cone 940mm high

Lamp	Domed top		Flat top		Weight
	Black	Silver	Black	Silver	
26/32/42w TC-TEL	4048937	4048940	4058328	4058329	10.60kg
50/80w HME	4040710	4040718	4058337	4058338	11.50kg
50w HST	4041747	4041748	4058331	4058332	11.50kg
70w HST/HIT-CE	4040711	4040719	4058334	4058335	11.50kg

Stepped cone 450mm high

Lamp	Domed top		Flat top		Weight
	Black	Silver	Black	Silver	
26/32/42w TC-TEL	4061709	4061710	4061699	4061700	7.40kg
50/80w HME	4061715	4061716	4061705	4061706	8.30kg
50w HST	4061711	4061712	4061701	4061702	8.30kg
70w HST/HIT-CE	4061713	4061714	4061703	4061704	8.30kg

Accessories

	Angle	Black	Silver
Cut off shield	240°	4043619	4043620
Cut off shield	120°	4043621	4043622

Mounting root	4040715
(For setting into concrete when fixing into soil)	

Fuse cut out box	4040716	0.55kg
------------------	----------------	--------

Double pole/single phase, facilitates armoured cable. Fixings supplied to mount box on internal DIN rail within post. Note: Not suitable for 450mm high bollard.

Lynx-TE
TC-TEL 26/32w GX24q-3
42w GX24q-4

26w = 1800 lm
32w = 2400 lm
42w = 3200 lm

HSL-SC
MBF-U
HME 50w 80w E27

50w = 2000 lm
80w = 4000 lm

SHP-T
SON-T
HST 50w E27

50w = 3500 lm

CDM-TT
HIT-CE 70w E27

70w = 6300 lm

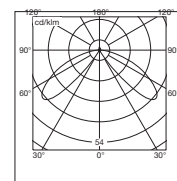
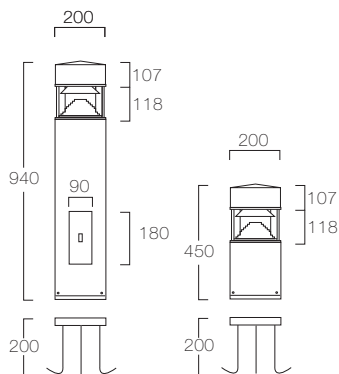
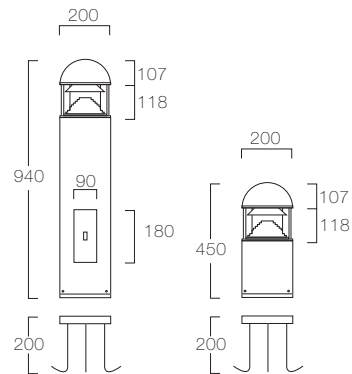
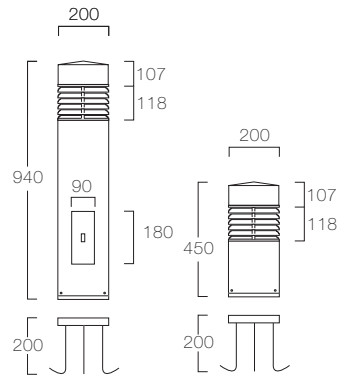
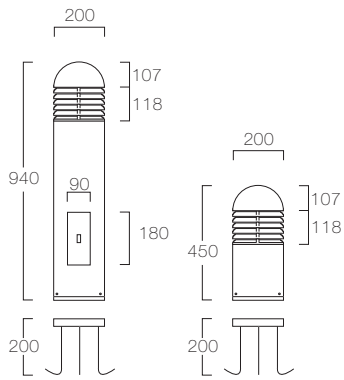

4040714

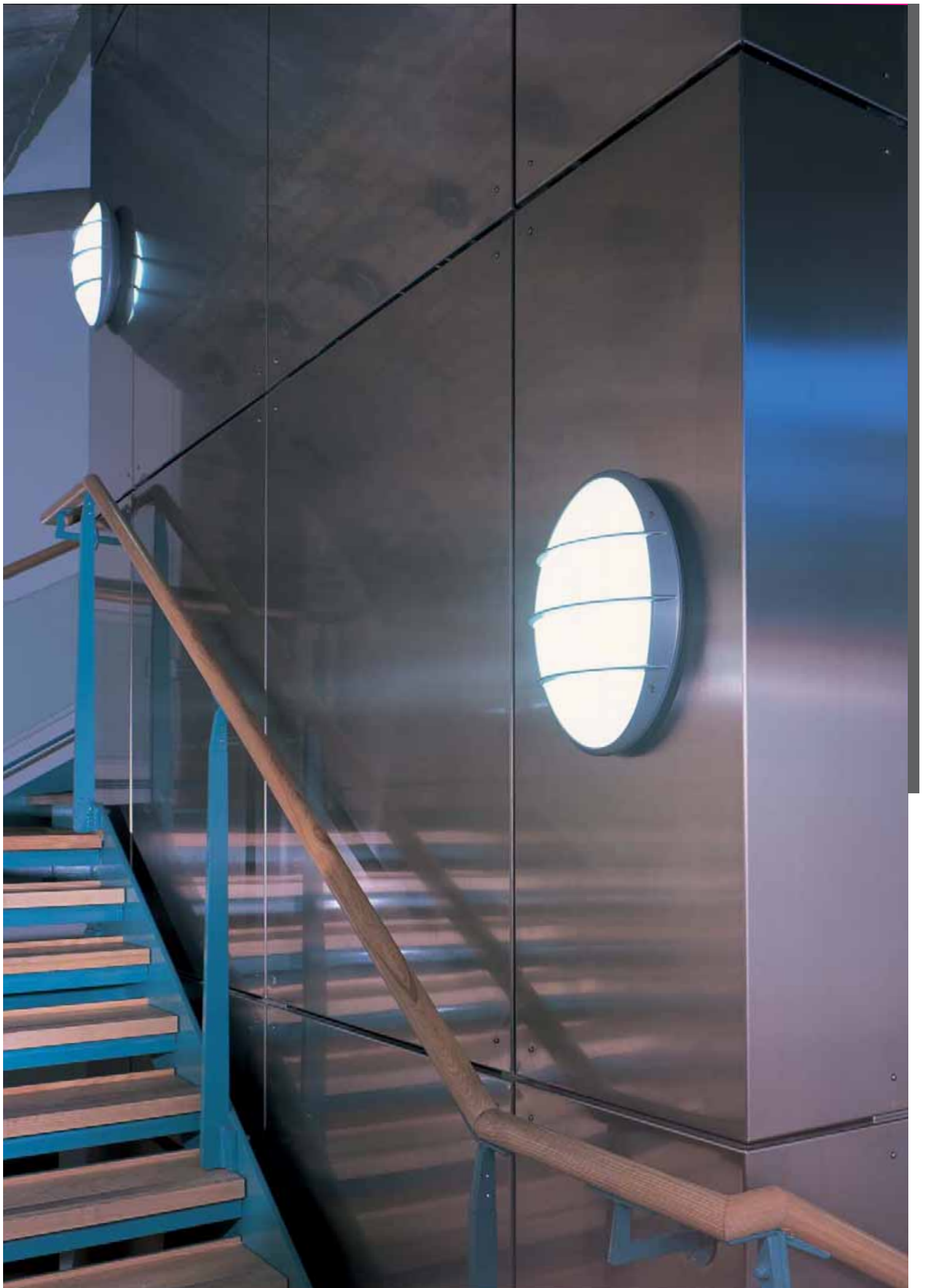

Brio IP65



IP65

- Attractive tough IK10 impact resistant construction
- 104-119mm discrete profiles
- Hood and grille versions
- Aesthetically pleasing designs
- IP65 water jet proof

IP65 Vandal Resistant

- Tough, functional IK10 impact resistant construction
- Sloped body and flush mounting make it ligature and vandal resistant
- Tamper resistant screws as standard
- Ideal for institutional environments
- Matching IP44 version available. See page 101

Control Gear:

Integral electronic gear

Emergency:

Integral, 3hr maintained

Diffuser:

Polycarbonate, satin opal

IP65 Housings/Trims:

Pressure die-cast aluminium, anti-corrosion pre-treated prior to powder coating white RAL 9016, black RAL 9005, silver RAL 9006

IP65 Retaining Screws:

Stainless steel

Brio

IP65

- Attractive, tough IK10 impact resistant construction
- 104-119mm discrete profile
- Aesthetically pleasing designs
- IP65 water jet proof

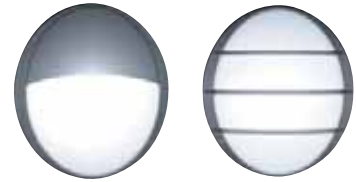

Standard	Emergency	White	Black	Silver	
28w TC-DD		4063645	-	4063649	3.05kg
28w TC-DD	Integral	4063646	-	4063650	3.85kg
38w TC-DD		-	4063653	4063655	3.05kg
38w TC-DD	Integral	-	4063654	4063656	3.85kg

Hood

2 x 18w TC-DEL		-	4063665	4063667	3.85kg
2 x 18w TC-DEL	Integral*	-	4063666	4063668	4.75kg
28w TC-DD		-	4063671	4063673	3.45kg
28w TC-DD	Integral	-	4063672	4063674	4.25kg
38w TC-DD		-	4063677	4063679	3.45kg
38w TC-DD	Integral*	-	4063678	4063680	4.25kg

3 Bar Grille

28w TC-DD		4063693	4063695	4063697	3.25kg
28w TC-DD	Integral	4063694	4063696	4063698	4.05kg
38w TC-DD		-	4063701	4063703	3.25kg
38w TC-DD	Integral	-	4063702	4063704	4.05kg

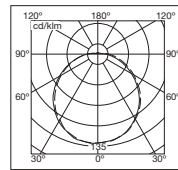

DLOR = 0.41
38w Standard

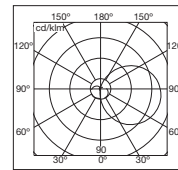

DLOR = 0.17
38w Hood

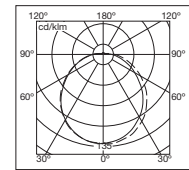

DLOR = 0.40
38w 3 Bar Grille

Accessory Order separately

Tamper resistant screws and key	4064201
---------------------------------	----------------

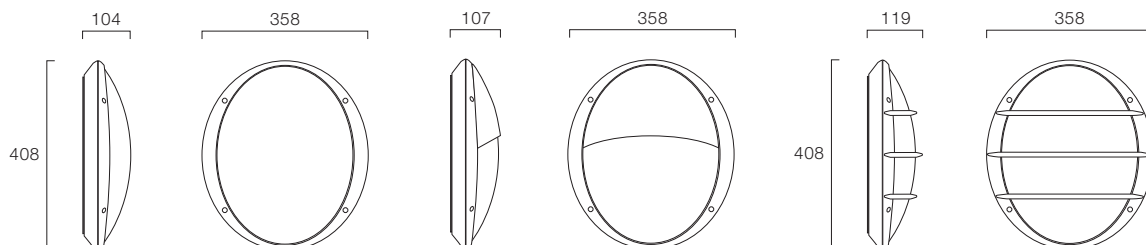
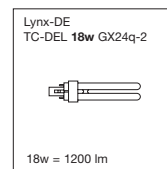
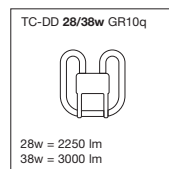

Brio

IP65 Vandal Resistant

- Tough, functional IK10 impact resistant construction
- Sloped body and flush mounting make it ligature and vandal resistant
- Tamper resistant screws as standard
- Ideal for institutional environments



	Emergency	White	Black	Silver	
2 x 18w TC-DEL		4064535	4064785	4064537	3.55kg
2 x 18w TC-DEL	Integral	4064536	4064786	4064538	4.35kg
28w TC-DD		4064481	4064787	4064483	3.55kg
28w TC-DD	Integral	4064482	4064788	4064484	4.35kg
38w TC-DD		4064485	4064789	4064487	3.55kg
38w TC-DD	Integral	4064486	4064790	4064488	4.35kg

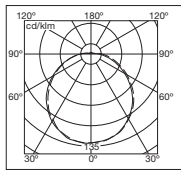

DLOR = 0.41
4064485

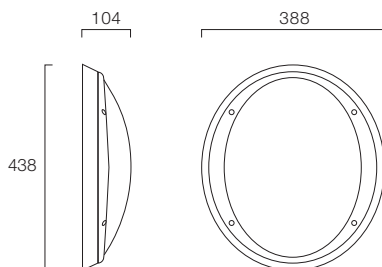
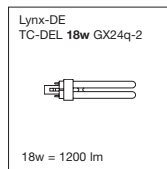
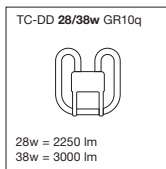



Sterling Bulkhead

- Pressure die cast housings and polycarbonate diffusers for extra vandal resistance
- 2 mounting options, surface and light halo
- Tamper resistant kit available



IP65 IK09 conforms to EN 60.598



Housing

Lamp	Emergency	Black	Silver	Weight
28w 2D		4037259	4041002	3.60kg
28w 2D	Integral	4037283	4041003	4.60kg
38w 2D		4043631	4043630	3.60kg
26w TC-D		4040999	4040995	3.60kg
26w TC-DE	Integral	4041001	-	4.60kg
Surface conduit pattress accessory		4037282	4041006	2.00kg

Light halo

Lamp	Emergency	Black	Silver	Weight
28w 2D		4037277	4040984	3.60kg
28w 2D	Integral	4037284	4040985	4.60kg
26w TC-D		4040981	4040977	3.60kg
26w TC-DE	Integral	4040983	4040979	4.60kg

Accessories Ordered in addition to fitting

	Black	Silver	Weight
Hood	4037279	4041005	0.50kg
3 Bar grille	4037280	4041004	0.20kg
X bar	4037281	4041007	0.20kg
Tamper resistant screws and key		4049172	

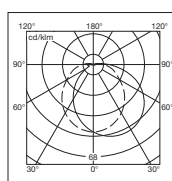
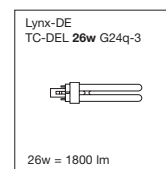
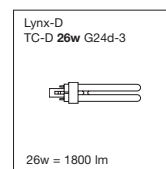
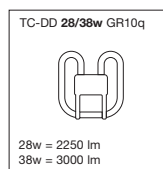
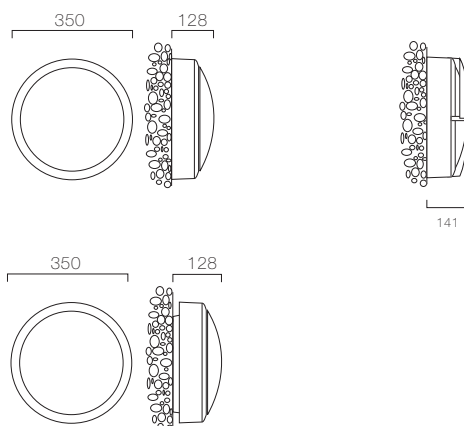

4043630 + 4041005

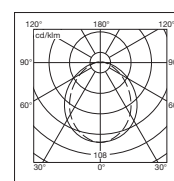

4043630 + 4041004

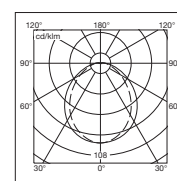

4043630 + 4041007

Control Gear : 28W 2D built in ballast and capacitor
26W TC-D built in ballast and capacitor

Emergency : Integral 3hr maintained

Diffuser : Flame retardant polycarbonate opal

Housing, trim and accessories : Pressure die cast aluminium, anti corrosion pre treated prior to powder coating black RAL 9005, silver RAL 9006

Retaining Screws : Stainless steel

Pattress : Steel removable blanking covers supplied

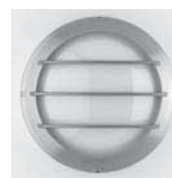

Sterling Asymmetric Bulkhead

- Complementary asymmetric version to Sterling Bulkhead range
- Unique textured diffuser to maximise distribution



IP65 IK09 conforms to EN 60.598 CE

Asymmetric Surface

Lamp	Black	Silver	Weight
26w/32w/42w TC-TEL	4064161	4064162	2.75kg
70w HIT-DE-CE	4064163	4064164	3.06kg
Surface conduit pattress accessory	4037282	-	2.00kg

Accessories ordered in addition to fitting

Tamper resistant screws and key	4049172
---------------------------------	----------------

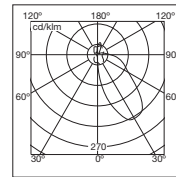
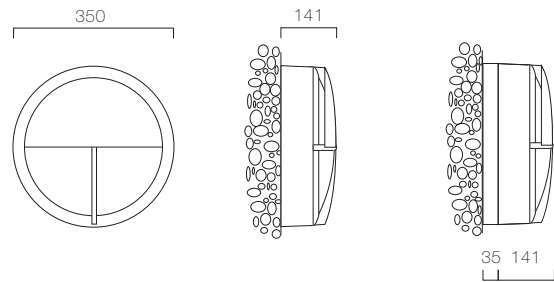

4064161

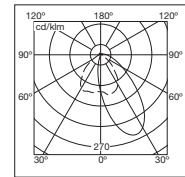

4064163

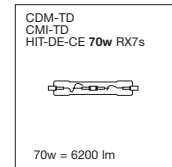
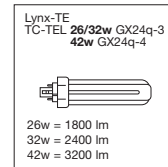

Control Gear :	26/32/42W TC-TEL integral electronic gear 70W HIT-DE-CE built in ballast, capacitor and ignitor
Emergency :	Integral 3hr maintained
Diffuser :	Flame retardant polycarbonate opal
Housing, trim and accessories :	Pressure die cast aluminium, anti corrosion pre treated prior to powder coating black RAL 9005, silver RAL 9006
Retaining Screws :	Stainless steel
Pattress :	Steel removable blanking covers supplied

Monitor

- Pressure die cast housing and polycarbonate diffuser for extra vandal resistance
- Emergency options for use on defined escape routes
- Pattress allows surface conduit entry



IP65 IK10 conforms to EN 60.598



Housing

Lamp	Emergency	White	Black	Silver	Weight
28w 2D		-	4045997	4045988	4.40kg
28w 2D	Integral	-	4045998	4045990	5.40kg
38w 2D		4046011	4046016	4046006	4.40kg
38w 2D	Integral	4046012	4046017	4046007	5.40kg
55w 2D		4046023	4046025	4046021	5.40kg

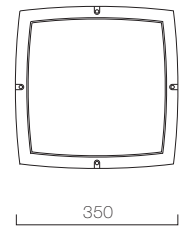
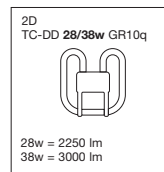

Accessories

Hood	-	4046028	4045981	0.75kg
4 Bar grille	-	4046027	4045980	0.30kg
Pattress	-	4045977	4045975	0.85kg

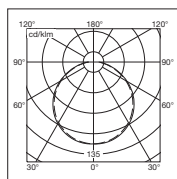
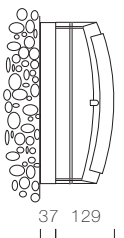
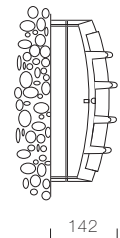
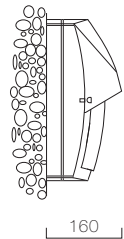
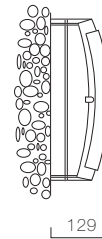
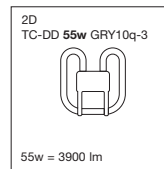

38w Standard

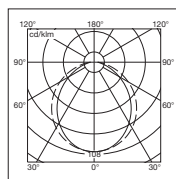

38w Hood

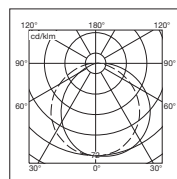

38w 3 Bar Grille

Control Gear :	28/38/55W 2D built in ballast and capacitor
Emergency :	Integral 3hr maintained
Diffuser :	Flame retardant polycarbonate opal
Housing, trim and accessories :	Pressure die cast aluminium, anti corrosion pre treated prior to powder coating white RAL9016, black RAL 9005, silver RAL 9006
Retaining Screws :	Stainless steel
Pattress :	ABS, removable blanking covers supplied

